

DEPARTMENT OF TRANSPORTATION
STATE OF GEORGIA

SPECIAL PRE-QUALIFICATION REQUIRED REVIEW COPY

PROPOSAL

DO NOT UNSTAPLE THIS BOOKLET...ENTER ALL REQUIRED INFORMATION
----- EITHER BY HAND OR BY STAMP.

DATE OF OPENING : December 12, 2008

CALL ORDER : 001

CONTRACT ID : B13095-08-000-0

PCN	PROJECTS AND CONTRACT NO.
----- 0008415010000	----- CSNHS-0008-00(415) 01

COUNTY : FULTON

CODE _____ ISSUED TO:

1. _____
2. _____
3. _____

**DEPARTMENT OF TRANSPORTATION
STATE OF GEORGIA**

DEPARTMENT OF TRANSPORTATION
STATE OF GEORGIA

CONTRACT ID : B13095-08-000-0
DESIGN BUILD PROJECT CONSISTING OF 0.885 MILE OF INTERCHANGE
RECONSTRUCTION AND BRIDGE CONSTRUCTION ON SR 400 AT
HAMMOND DR.
(FOS)

PROPOSAL GUARANTY : 5%

DBE GOAL : 12.00 %

SITE	COMPLETION DATE	CONTRACT TIME	LIQUIDATED DAMAGES
00	08/31/11	COMPLETION DATE	
COMPLETE CONTRACT			
01		AVAILABLE DAYS	
FAIL TO REOPEN LANES - SEE SPEC		PROV SEC 108	
02		3 CALENDAR DAYS	
FAIL TO RESTORE SERVICE ITS SYSTEM - SEE SPEC		PROV SEC 108	
03		180 CALENDAR DAYS	
FAIL TO SUBMIT UTILITY CONFLICT MATRIX - SEE SPEC		PRO SE 108	
04		120 CALENDAR DAYS	
FAIL TO SUBMIT UTILITY STATUS REPORT - SEE SPEC		PROV SEC 108	

NOTICE TO BIDDERS

If a DBE goal is specified, the bidder shall submit with this bid proposal a list of all proposed DBE participants. A form for this purpose is provided in this proposal. Please refer to the following specifications:

102.07 Rejection of Proposals
Disadvantaged Business Enterprise Program (Special Provision)

BIDDERS SHALL ENTER ALL UNIT PRICES, MAKE ALL EXTENSIONS AND TOTAL THE BID.

**DEPARTMENT OF TRANSPORTATION
STATE OF GEORGIA**

DEPARTMENT OF TRANSPORTATION
 STATE OF GEORGIA
 SCHEDULE OF ITEMS

PAGE: 1
 DATE: 10/22/08

CONTRACT ID: B13095-08-000-0
 PROJECT(S) : 0008415010000 CSNHS-0008-00(415) 01

LINE NO	ITEM DESCRIPTION	APPROX. QUANTITY AND UNITS	UNIT PRICE DOLLARS CTS	BID AMOUNT DOLLARS CTS
SECTION 0001 ROADWAY				
0005	150-9011 TRAFFIC CONTROL - WORKZONE LAW ENFORCEMENT (CONTRACTOR BIDS)	1,200.000 HR		.
0010	158-1000 TRAINING HOURS	5,000.000 HR	0.80000	4,000.00
0015	999-2010 DESIGN COMPLETE	LUMP	LUMP	.
0020	999-2015 CONSTRUCTION COMPLETE	LUMP	LUMP	.
	SECTION 0001 TOTAL			.
	TOTAL BID		ENTER BID TOTAL ON NEXT PAGE	.

**DEPARTMENT OF TRANSPORTATION
STATE OF GEORGIA**

DEPARTMENT OF TRANSPORTATION
 STATE OF GEORGIA
 SCHEDULE OF ITEMS

PAGE: 2
 DATE: 10/22/08

*** LIST ON THIS PAGE ***
 *** ITEMS ADDED BY ***
 *** AMENDMENT ***

CONTRACT ID: B13095-08-000-0
 PROJECT(S) : 0008415010000 CSNHS-0008-00(415) 01

LINE NO	ITEM DESCRIPTION	APPROX. QUANTITY AND UNITS	UNIT PRICE		BID AMOUNT	
			DOLLARS	CTS	DOLLARS	CTS
				.		.
				.		.
				.		.
				.		.
				.		.
				.		.
				.		.
				.		.
				.		.
				.		.
				.		.
				.		.
				.		.
				.		.
				.		.
TOTAL BID				.		.



**DEPARTMENT OF TRANSPORTATION
STATE OF GEORGIA**

DBE GOALS

VENDOR ID: _____ BIDDER'S COMPANY NAME: _____

PROJECT NO. & COUNTY: **CSNHS-0008-00(415) FULTON**

LET NO: 001 LET DATE: **December 12, 2008** TOTAL BID: _____

THE REQUIRED DBE GOAL ON THIS CONTRACT IS: 12%

I PROPOSE TO UTILIZE THE FOLLOWING DBE'S:

LIST OF DBE PARTICIPANTS

*VENDOR NUMBER	DBE NAME/ ADDRESS (CITY, STATE)	TYPE OF WORK	Race Neutral	Race Conscious	*WORK CODE	AMOUNT
TOTAL						

*For Departmental use only. Do not fill in Work codes.

PLEASE NOTE: Only 60 % of the participation of a DBE Supplier who does not manufacture or install the product will be counted toward the goal. See below for further instructions.

INSTRUCTIONS FOR LIST OF DBE PARTICIPANTS

If a DBE Goal is indicated, you must propose to achieve a goal that is equal or greater than the percentage required. If no goal is indicated, you may propose your own goal.

The DBE Firms to be utilized as counting toward the proposed goal must be listed on this form, along with their addresses, type of work and the amount to be paid to each of the minority firms. The amount entered will not necessarily be the contract amount, but must be the actual amount that will be paid to the DBE firm. In the case of a DBE supplier, the amount paid and 60% of that amount both will be entered; and only the 60% figure should be added to the total. An example of this is shown in the example chart:

Vendor Number	Company Name And Address (City and State)	Type of Work	* Work Code	Race Neutral	Race Conscious	Amount
	ABC Oil Company Atlanta, GA	Diesel Fuel Supplier				\$80,000.00 (60% = \$48,000.00)

* For Departmental use ONLY. Do not fill in Work Codes.

The Contractor shall indicate for each DBE and Type of Work whether the DBE Participant is Race Neutral or Race Conscious by placing a checkmark in the appropriate column.

PLEASE NOTE: For 60% of the amount paid to a DBE supplier to be eligible to count toward fulfilling the DBE goal, the supplier must be an established “regular dealer” in the product involved, and not just a broker. A “regular dealer” would normally sell the product to several customers and would usually have product inventory on hand.

PRIME CONTRACTOR’S WORK AUTHORIZATION CERTIFICATION

Pursuant to O.C.G.A. § 13-10-91, all qualifying contractors and sub-contractors performing work within the State of Georgia on a contract with a public employer must register and participate in a federal work authorization program. Prime contractors may participate in any of the electronic verification of work authorization programs operated by the United States Department of Homeland Security or any equivalent federal work authorization program operated by the United States Department of Homeland Security to verify information of newly hired employees, pursuant to the Immigration Reform and Control Act of 1986 (“IRCA”).

The date by which a prime contractor must register and participate in a qualifying federal work authorization program depends on the number of employees in the prime contractor’s company. If the prime contractor’s company has 500 or more employees, it is required to register and participate in a qualifying federal work authorization program by July 1, 2007. If the prime contractor’s company has 100 or more employees, it is required to register for and participate in a qualifying federal work authorization program by July 1, 2008. If the prime contractor’s company has 99 employees or fewer, it is required to register for and participate in a qualifying federal work authorization program by July 1, 2009.

Certify compliance with O.C.G.A. § 13-10-91 by checking the appropriate line below:

_____ The undersigned has registered for and is participating in a qualifying federal work authorization program;

or,

_____ The undersigned is not required to register for or participate in a qualifying federal work authorization program at this time. But, if the undersigned becomes a qualifying prime contractor in the future, the undersigned agrees to register for and participate in a qualifying federal work authorization program.

The undersigned further agrees that, should it employ or contract with any subcontractor(s) in connection with the physical performance of services within this state pursuant to this contract with a public employer, the undersigned will secure from such subcontractor(s) a verification of compliance with O.C.G.A. § 13-10-91 using the form “Subcontractor’s Work Authorization Certification” or a substantially similar form. The undersigned will maintain records of compliance and provide a copy of each sub-contractor’s verification to the public employer at the time the sub-contractor is retained to perform such service.

[SIGNATURE ON NEXT PAGE]

BY: Authorized Officer or Agent

Date

Title of Authorized Officer or Agent

Basic Pilot User Identification Number
(if applicable)

Printed Name of Authorized Officer
or Agent

With express authority on behalf of:

Printed Name of Prime Contractor

SUBSCRIBED AND SWORN
BEFORE ME ON THIS THE
_____ DAY OF _____, 20__.

Notary Public

My Commission Expires: _____

**DEPARTMENT OF TRANSPORTATION
STATE OF GEORGIA**

FEDERAL AID CERTIFICATION
(English Project)

August 23, 2001

First Use Date 2001 Specifications: November 1, 2002

Failure to complete appropriate certification requirements identified below or submission of a false certification shall render the bid non-responsive.

EQUAL EMPLOYMENT OPPORTUNITY

I further certify that I have ___/have not ___ participated in a previous contract or subcontract subject to the equal opportunity clause, as required by Executive Orders 10925, 11114, or 11246, and that I have ___ / have not ___ filed with the Joint Reporting Committee, the Director of the *Office of Federal Contract Compliance*, a Federal Government contracting or administering agency, or the former *President's Committee on Equal Employment Opportunity*, all reports due under the applicable filing requirements.

I understand that if I have participated in a previous Contract or Subcontract subject to the Executive Orders above and have not filed the required reports that 41 CFR 60-1.7(b)(1) prevents the award of this Contract unless I submit a report governing the delinquent period or such other period specified by the Federal Highway Administration or by the Director, Office of Federal Contract Compliance, U. S. Department of Labor.

Reports and notifications required under 41 CFR 604, including reporting subcontract awards in excess of \$10,000.00 should be addressed to:

Ms. Carol Gaudin
Regional Director, U. S. Department of Labor
Office of Federal Contract Compliance Programs, Region 4
Rm. 7B75
61 Forsyth St. SW
Atlanta GA 30303

EXAMINATION OF PLANS AND SPECIFICATIONS

I acknowledge that this Project will be constructed in English units.

I certify that I have carefully examined the Plans for this Project and the Standard Specifications, 2001 Edition, and the Supplemental Specifications and Special Provisions included in and made a part of this Proposal, and have also personally examined the site of the work. On the basis of the said Specifications and Plans, I propose to furnish all necessary machinery, tools, apparatus and other means of construction, and do all the work and furnish all the materials in the manner specified.

I understand the quantities mentioned are approximate only and are subject to either increase or decrease and hereby propose to perform any increased or decreased quantities of work or extra work on the basis provided for in the Specifications.

**DEPARTMENT OF TRANSPORTATION
STATE OF GEORGIA**

I also hereby agree that the State, or the Department of Transportation, would suffer damages in a sum equal to at least the amount of the enclosed Proposal Guaranty, in the event my Proposal should be accepted and a Contract tendered me thereunder and I should refuse to execute same and furnish bond as herein required, in consideration of which I hereby agree that, in the event of such failure on my part to execute said Contract and furnish bond within fifteen (15) days after the date of the letter transmitting the Contract to me, the amount of said Proposal Guaranty shall be and is hereby, forfeited to the State, or to the Department of Transportation, as liquidated damages as the result of such failure on my part.

I further propose to execute the Contract agreement described in the Specifications as soon as the work is awarded to me, and to begin and complete the work within the time limit provided. I also propose to furnish a Contract Bond, approved by the State Transportation Board, as required by the laws of the State of Georgia. This bond shall not only serve to guarantee the completion of the work on my part, but also to guarantee the excellence of both workmanship and materials until the work is finally accepted, as well as to fully comply with all the laws of the State of Georgia.

CONFLICT OF INTEREST

By signing and submitting this Contract I hereby certify that employees of this company or employee of any company supplying material or subcontracting to do work on this Contract will not engage in business ventures with employees of the Georgia Department of Transportation (GA D.O.T.) nor shall they provide gifts, gratuities, favors, entertainment, loans or other items of value to employees of this department.

Also, by signing and submitting this Contract I hereby certify that I will notify the Georgia Department of Transportation through its District Engineer of any business ventures entered into between employees of this company or employees of any company supplying material or subcontracting to do work on this Contract with a family member of GA D.O.T. employees.

DRUG FREE WORKPLACE

The undersigned certifies that the provisions of Code Sections 50-24-1 through 50-24-6 of the Official Code of Georgia Annotated, relating to the "Drug-free Workplace Act", have been complied with in full. The undersigned further certifies that:

- (1) A drug-free workplace will be provided for the Contractor's employees during the performance of the Contract; and
- (2) Each Contractor who hires a Subcontractor to work in a drug-free workplace shall secure from that Subcontractor the following written certification:

"As part of the subcontracting agreement with _____ (Contractor's name), _____ (Subcontractor's name) _____ certifies to the Contractor that a drug free workplace will be provided for the Subcontractor's employees during the performance of this Contract pursuant to paragraph (7) of subsection (b) of Code Section 50-24-3."

Also, the undersigned further certifies that he will not engage in the unlawful manufacture, sale distribution, dispensation, possession, or use of a controlled substance or marijuana during the performance of the Contract.

**DEPARTMENT OF TRANSPORTATION
STATE OF GEORGIA**

NON-COLLUSION CERTIFICATION

I hereby certify that I have not, nor has any member of the firm(s) or corporation(s), either directly or indirectly entered into any agreement, participated in any collusion, nor otherwise taken any action in restraint of free competitive bidding in connection with this submitted bid.

It is understood and agreed that this Proposal is one of several competitive bids made to the Department of Transportation, and in consideration of mutual agreements of the bidders, similar hereto, and in consideration of the sum of One Dollar cash in hand paid, receipt whereof is hereby acknowledged, the undersigned agrees that this Proposal shall be an option, which is hereby given by the undersigned to the Department of Transportation to accept or reject this Proposal at any time within thirty (30) calendar days from the date on which this sealed proposal is opened and read, unless a longer period is specified in the Proposal or the successful bidder agrees in writing to a longer period of time for the award, and in consideration of the premises, it is expressly covenanted and agreed that this Proposal is not subject to withdrawal by the Proposer or Bidder, during the term of said option.

I hereby acknowledge receipt of the following checked amendments of the Proposal, Plans, Specifications and/or other documents pertaining to the Contract.

Amendment Nos.: 1 2 3 4 5 . I understand that failure to confirm the receipt of amendments is cause for rejection of bids.

Witness my hand and seal this the _____ day of _____, 20_____.

The bidder(s) whose signature(s) appear on this document, having personally appeared before me, and being duly sworn, deposes and says that the above statements are true and correct.

Sworn to and subscribed before me this _____ day of _____, 20_____.

(Notary Public)

My Commission expires the _____ day of _____, 20_____.

(Federal ID No./IRS No.)

(Print Company Name)

By _____ (Seal)
Corporate President/Vice President or
Individual Owner or Partner (Strike
through all except the one which applies.)

Joint Bidder:

(Print Company Name)

By _____ (Seal)
Corporate President/Vice President or
Individual Owner or Partner (Strike
through all except the one which applies.)

Joint Bidder:

(Print Company Name)

By _____ (Seal)
Corporate President/Vice President or
or Individual Owner or Partner (Strike
through all except the one which applies.)

**DEPARTMENT OF TRANSPORTATION
STATE OF GEORGIA**

Call Order Number: 001

County: **Fulton****PROPOSAL INDEX**Project No(s): **CSNHS-0008-00(415)****Listed below are modifications and additions to the 2001 State of Georgia Standard Specifications Constructions of****Transportation System and the 2008 Supplemental Specifications modifying the 2001 Standard Specifications.**

DBE Requirements
 Prime Contractors Work Authorized Form
 Federal Aid Requirements
 Certification/Drug Free Workplace
 Signature Page
 Proposal Index
 Notice to All Bidders
 Federal Labor Provisions (FHWA 1273)
 Notice to Contractors
 Wage Rates
 Standard EEO Specifications
 Notice of Affirmative Action
 Disadvantaged Business Enterprise Program
 Prompt Payment
 Buy America
 Utility Conflicts
 Sec. 102 - Bidding Requirements and Conditions (2)
 Sec. 104 – Scope of Work
 Sec. 107 - Legal Regulation and Responsibility to the Public
 Sec. 108 - Prosecution and Progress
 Sec. 109 - Measurement and Payment
 Sec. 149 - Construction Layout
 Sec. 150 - Traffic Control
 Sec. 153 - Field Engineers Office
 Sec. 161 - Control of Soil Erosion and Sedimentation
 Sec. 163 - Miscellaneous Erosion Control
 Sec. 165 - Maintenance of Temporary Erosion and Sedimentation Control Devices
 Sec. 167 - Water Quality Monitoring
 Sec. 170 - Silt Retention Barrier
 Sec. 171 - Silt Fence
 Sec. 400 - Hot Mix Asphaltic Concrete Construction
 Sec. 402 - Hot Mix Recycled Asphaltic Concrete
 Sec. 413 - Bituminous Tack Coat
 Sec. 424 - Bituminous Surface Treatment
 Sec. 439 – Portland Cement Concrete Pavement
 Sec. 442 – Roller Compacted Concrete Pavement
 Sec. 500 - Concrete Structures
 Sec. 511 – Reinforced Steel
 Sec. 550 – Storm drain Pipe, Pipe-Arch Culverts, and Side Drain
 Sec. 620 - Temporary Barrier
 Sec. 636 - Highway Signs
 Sec. 647 - Traffic Signal Installation
 Sec. 648 - Traffic Impact Attenuator
 Sec. 652 - Painting Traffic Stripe (Polyurea)
 Sec. 653 - Thermoplastic Traffic Stripe
 Sec. 657 - Wet Reflective Preformed Pavement Markings
 Sec. 700 - Grassing
 Sec. 702 - Vine, Shrubs, And Tree Planting
 Sec. 814 - Soil Base Materials
 Sec. 820 - Asphalt Cement
 Sec. 863 - Preservative Treatment of Timber Products
 Sec. 865 – Manufacture of Pre-stressed Concrete Bridge Member
 Sec. 881 - Fabrics
 Sec. 894 - Fencing
 Sec. 895 - Polyacrylamide (Pam)
 Sec. 913 - Reflectorizing Material
 Sec. 917 - Reflectors and Non Reflective Characters

Sec. 919 - Raised Pavement Markers
 Sec. 925 - Traffic Signal Equipment
 Sec. 934 - Rapid Setting Patching Materials for Portland Cement Concrete

Escrow Bid
 Memorandum of Understanding (6)
 Sec. 103 – Award and Execution of Contract
 Sec. 107 – Legal Regulations and Responsibility to the public (2)
 Sec. 108 – Prosecution and Progress
 Sec. 150 – Traffic Control
 Sec. 500 – Concrete Structures
 Sec. 713 – Organic and Synthetic Material Fiber Blanket
 Sec. 999 – Design Build

**DEPARTMENT OF TRANSPORTATION
STATE OF GEORGIA**

NOTICE TO ALL BIDDERS

To report bid rigging activities call:

1-800-424-9071

The U.S. Department of Transportation (DOT) operates the above toll-free “hotline” Monday through Friday, 8:00 AM to 5:00 PM, Eastern Time. Anyone with the knowledge of possible bid rigging, bidder collusion, or other fraudulent activities should use the “hotline” to report such activities.

The “hotline” is part of the DOT’s continuing effort to identify and investigate highway construction contract fraud and abuse, and is operated under the direction of the DOT Inspector General. All information will be treated confidentially and caller anonymity will be respected.

**DEPARTMENT OF TRANSPORTATION
STATE OF GEORGIA**

Required Contract Provisions Federal-Aid Construction Contracts

- I. [General](#)
- II. [Nondiscrimination](#)
- III. [Nonsegregated Facilities](#)
- IV. [Payment of Predetermined Minimum Wage](#)
- V. [Statements and Payrolls](#)
- VI. [Record of Materials, Supplies, and Labor](#)
- VII. [Subletting or Assigning the Contract](#)
- VIII. [Safety: Accident Prevention](#)
- IX. [False Statements Concerning Highway Projects](#)
- X. [Implementation of Clean Air Act and Federal Water Pollution Control Act](#)
- XI. [Certification Regarding Debarment, Suspension Ineligibility, and Voluntary Exclusion](#)
- XII. [Certification Regarding Use of Contract Funds for Lobbying](#)

Attachments

- A. [Employment Preference for Appalachian Contracts \(included in Appalachian contracts only\)](#)
- I. **GENERAL**
 1. These contract provisions shall apply to all work performed on the contract by the contractor's own organization and with the assistance of workers under the contractor's immediate superintendence and to all work performed on the contract by piecework, station work, or by subcontract.
 2. Except as otherwise provided for in each section, the contractor shall insert in each subcontract all of the stipulations contained in these Required Contract Provisions, and further require their inclusion in any lower tier subcontract or purchase order that may in turn be made. The Required Contract Provisions shall not be incorporated by reference in any case. The prime contractor shall be responsible for compliance by any subcontractor or lower tier subcontractor with these Required Contract Provisions.
 3. A breach of any of the stipulations contained in these Required Contract Provisions shall be sufficient grounds for termination of the contract.
 4. A breach of the following clauses of the Required Contract Provisions may also be grounds for debarment as provided in 29 CFR 5.12:

Section I, paragraph 2;
Section IV, paragraphs 1, 2, 3, 4, and 7;
Section V, paragraphs 1 and 2a through 2g.
 5. Disputes arising out of the labor standards provisions of Section IV (except paragraph 5) and Section V of these Required Contract Provisions shall not be subject to the general disputes clause of this contract. Such disputes shall be resolved in accordance with the procedures of the U.S. Department of Labor (DOL) as set forth in 29 CFR 5, 6, and 7. Disputes within the meaning of this clause include disputes between the contractor (or any of its subcontractors) and the contracting agency, the DOL, or the contractor's employees or their representatives.
 6. **Selection of Labor:** During the performance of this contract, the contractor shall not:

- a. discriminate against labor from any other State, possession, or territory of the United States (except for employment preference for Appalachian contracts, when applicable, as specified in Attachment A), or
- b. employ convict labor for any purpose within the limits of the project unless it is labor performed by convicts who are on parole, supervised release, or probation.

II. NONDISCRIMINATION

(Applicable to all Federal-aid construction contracts and to all related subcontracts of \$10,000 or more.)

1. **Equal Employment Opportunity:** Equal employment opportunity (EEO) requirements not to discriminate and to take affirmative action to assure equal opportunity as set forth under laws, executive orders, rules, regulations (28 CFR 35, 29 CFR 1630 and 41 CFR 60) and orders of the Secretary of Labor as modified by the provisions prescribed herein, and imposed pursuant to 23 U.S.C. 140 shall constitute the EEO and specific affirmative action standards for the contractor's project activities under this contract. The Equal Opportunity Construction Contract Specifications set forth under 41 CFR 60-4.3 and the provisions of the American Disabilities Act of 1990 (42 U.S.C. 12101 et seq.) set forth under 28 CFR 35 and 29 CFR 1630 are incorporated by reference in this contract. In the execution of this contract, the contractor agrees to comply with the following minimum specific requirement activities of EEO:
 - a. The contractor will work with the State highway agency (SHA) and the Federal Government in carrying out EEO obligations and in their review of his/her activities under the contract.
 - b. The contractor will accept as his operating policy the following statement:

"It is the policy of this Company to assure that applicants are employed, and that employees are treated during employment, without regard to their race, religion, sex, color, national origin, age or disability. Such action shall include: employment, upgrading, demotion, or transfer; recruitment or recruitment advertising; layoff or termination; rates of pay or other forms of compensation; and selection for training, including apprenticeship, pre-apprenticeship, and/or on-the-job training."
2. **EEO Officer:** The contractor will designate and make known to the SHA contracting officers an EEO Officer who will have the responsibility for and must be capable of effectively administering and promoting an active contractor program of EEO and who must be assigned adequate authority and responsibility to do so.
3. **Dissemination of Policy:** All members of the contractor's staff who are authorized to hire, supervise, promote, and discharge employees, or who recommend such action, or who are substantially involved in such action, will be made fully cognizant of, and will implement, the contractor's EEO policy and contractual responsibilities to provide EEO in each grade and classification of employment. To ensure that the above agreement will be met, the following actions will be taken as a minimum:
 - a. Periodic meetings of supervisory and personnel office employees will be conducted before the start of work and then not less often than once

- every six months, at which time the contractor's EEO policy and its implementation will be reviewed and explained. The meetings will be conducted by the EEO Officer.
- b. All new supervisory or personnel office employees will be given a thorough indoctrination by the EEO Officer, covering all major aspects of the contractor's EEO obligations within thirty days following their reporting for duty with the contractor.
 - c. All personnel who are engaged in direct recruitment for the project will be instructed by the EEO Officer in the contractor's procedures for locating and hiring minority group employees.
 - d. Notices and posters setting forth the contractor's EEO policy will be placed in areas readily accessible to employees, applicants for employment and potential employees.
 - e. The contractor's EEO policy and the procedures to implement such policy will be brought to the attention of employees by means of meetings, employee handbooks, or other appropriate means.
4. **Recruitment:** When advertising for employees, the contractor will include in all advertisements for employees the notation: "An Equal Opportunity Employer." All such advertisements will be placed in publications having a large circulation among minority groups in the area from which the project work force would normally be derived.
- a. The contractor will, unless precluded by a valid bargaining agreement, conduct systematic and direct recruitment through public and private employee referral sources likely to yield qualified minority group applicants. To meet this requirement, the contractor will identify sources of potential minority group employees, and establish with such identified sources procedures whereby minority group applicants may be referred to the contractor for employment consideration.
 - b. In the event the contractor has a valid bargaining agreement providing for exclusive hiring hall referrals, he is expected to observe the provisions of that agreement to the extent that the system permits the contractor's compliance with EEO contract provisions. (The DOL has held that where implementation of such agreements have the effect of discriminating against minorities or women, or obligates the contractor to do the same, such implementation violates Executive Order 11246, as amended.)
 - c. The contractor will encourage his present employees to refer minority group applicants for employment. Information and procedures with regard to referring minority group applicants will be discussed with employees.
5. **Personnel Actions:** Wages, working conditions, and employee benefits shall be established and administered, and personnel actions of every type, including hiring, upgrading, promotion, transfer, demotion, layoff, and termination, shall be taken without regard to race, color, religion, sex, national origin, age or disability. The following procedures shall be followed:
- a. The contractor will conduct periodic inspections of project sites to insure that working conditions and employee facilities do not indicate discriminatory treatment of project site personnel.
 - b. The contractor will periodically evaluate the spread of wages paid within each classification to determine any evidence of discriminatory wage practices.

- c. The contractor will periodically review selected personnel actions in depth to determine whether there is evidence of discrimination. Where evidence is found, the contractor will promptly take corrective action. If the review indicates that the discrimination may extend beyond the actions reviewed, such corrective action shall include all affected persons.
 - d. The contractor will promptly investigate all complaints of alleged discrimination made to the contractor in connection with his obligations under this contract, will attempt to resolve such complaints, and will take appropriate corrective action within a reasonable time. If the investigation indicates that the discrimination may affect persons other than the complainant, such corrective action shall include such other persons. Upon completion of each investigation, the contractor will inform every complainant of all of his avenues of appeal.
6. **Training and Promotion:**
- a. The contractor will assist in locating, qualifying, and increasing the skills of minority group and women employees, and applicants for employment.
 - b. Consistent with the contractor's work force requirements and as permissible under Federal and State regulations, the contractor shall make full use of training programs, i.e., apprenticeship, and on-the-job training programs for the geographical area of contract performance. Where feasible, 25 percent of apprentices or trainees in each occupation shall be in their first year of apprenticeship or training. In the event a special provision for training is provided under this contract, this subparagraph will be superseded as indicated in the special provision.
 - c. The contractor will advise employees and applicants for employment of available training programs and entrance requirements for each.
 - d. The contractor will periodically review the training and promotion potential of minority group and women employees and will encourage eligible employees to apply for such training and promotion.
7. **Unions:** If the contractor relies in whole or in part upon unions as a source of employees, the contractor will use his/her best efforts to obtain the cooperation of such unions to increase opportunities for minority groups and women within the unions, and to effect referrals by such unions of minority and female employees. Actions by the contractor either directly or through a contractor's association acting as agent will include the procedures set forth below:
- a. The contractor will use best efforts to develop, in cooperation with the unions, joint training programs aimed toward qualifying more minority group members and women for membership in the unions and increasing the skills of minority group employees and women so that they may qualify for higher paying employment.
 - b. The contractor will use best efforts to incorporate an EEO clause into each union agreement to the end that such union will be contractually bound to refer applicants without regard to their race, color, religion, sex, national origin, age or disability.
 - c. The contractor is to obtain information as to the referral practices and policies of the labor union except that to the extent such information is within the exclusive possession of the labor union and such labor union refuses to furnish such information to the contractor, the contractor shall so certify to the SHA and shall set forth what efforts have been made to obtain such information.

- d. In the event the union is unable to provide the contractor with a reasonable flow of minority and women referrals within the time limit set forth in the collective bargaining agreement, the contractor will, through independent recruitment efforts, fill the employment vacancies without regard to race, color, religion, sex, national origin, age or disability; making full efforts to obtain qualified and/or qualifiable minority group persons and women. (The DOL has held that it shall be no excuse that the union with which the contractor has a collective bargaining agreement providing for exclusive referral failed to refer minority employees.) In the event the union referral practice prevents the contractor from meeting the obligations pursuant to Executive Order 11246, as amended, and these special provisions, such contractor shall immediately notify the SHA.
8. **Selection of Subcontractors, Procurement of Materials and Leasing of Equipment:** The contractor shall not discriminate on the grounds of race, color, religion, sex, national origin, age or disability in the selection and retention of subcontractors, including procurement of materials and leases of equipment.
- a. The contractor shall notify all potential subcontractors and suppliers of his/her EEO obligations under this contract.
 - b. Disadvantaged business enterprises (DBE), as defined in 49 CFR 23, shall have equal opportunity to compete for and perform subcontracts which the contractor enters into pursuant to this contract. The contractor will use his best efforts to solicit bids from and to utilize DBE subcontractors or subcontractors with meaningful minority group and female representation among their employees. Contractors shall obtain lists of DBE construction firms from SHA personnel.
 - c. The contractor will use his best efforts to ensure subcontractor compliance with their EEO obligations.
9. **Records and Reports:** The contractor shall keep such records as necessary to document compliance with the EEO requirements. Such records shall be retained for a period of three years following completion of the contract work and shall be available at reasonable times and places for inspection by authorized representatives of the SHA and the FHWA.
- a. The records kept by the contractor shall document the following:
 - 1. The number of minority and non-minority group members and women employed in each work classification on the project;
 - 2. The progress and efforts being made in cooperation with unions, when applicable, to increase employment opportunities for minorities and women;
 - 3. The progress and efforts being made in locating, hiring, training, qualifying, and upgrading minority and female employees; and
 - 4. The progress and efforts being made in securing the services of DBE subcontractors or subcontractors with meaningful minority and female representation among their employees.
 - b. The contractors will submit an annual report to the SHA each July for the duration of the project, indicating the number of minority, women, and non-minority group employees currently engaged in each work classification required by the contract work. This information is to be reported on Form FHWA-1391. If on-the-job training is being required by special provision, the contractor will be required to collect and report training data.

III. **NONSEGREGATED FACILITIES**

(Applicable to all Federal-aid construction contracts and to all related subcontracts of \$10,000 or more.)

- a. By submission of this bid, the execution of this contract or subcontract, or the consummation of this material supply agreement or purchase order, as appropriate, the bidder, Federal-aid construction contractor, subcontractor, material supplier, or vendor, as appropriate, certifies that the firm does not maintain or provide for its employees any segregated facilities at any of its establishments, and that the firm does not permit its employees to perform their services at any location, under its control, where segregated facilities are maintained. The firm agrees that a breach of this certification is a violation of the EEO provisions of this contract. The firm further certifies that no employee will be denied access to adequate facilities on the basis of sex or disability.
- b. As used in this certification, the term "segregated facilities" means any waiting rooms, work areas, restrooms and washrooms, restaurants and other eating areas, timeclocks, locker rooms, and other storage or dressing areas, parking lots, drinking fountains, recreation or entertainment areas, transportation, and housing facilities provided for employees which are segregated by explicit directive, or are, in fact, segregated on the basis of race, color, religion, national origin, age or disability, because of habit, local custom, or otherwise. The only exception will be for the disabled when the demands for accessibility override (e.g. disabled parking).
- c. The contractor agrees that it has obtained or will obtain identical certification from proposed subcontractors or material suppliers prior to award of subcontracts or consummation of material supply agreements of \$10,000 or more and that it will retain such certifications in its files.

IV. **PAYMENT OF PREDETERMINED MINIMUM WAGE**

(Applicable to all Federal-aid construction contracts exceeding \$2,000 and to all related subcontracts, except for projects located on roadways classified as local roads or rural minor collectors, which are exempt.)

1. **General:**

- a. All mechanics and laborers employed or working upon the site of the work will be paid unconditionally and not less often than once a week and without subsequent deduction or rebate on any account [except such payroll deductions as are permitted by regulations (29 CFR 3) issued by the Secretary of Labor under the Copeland Act (40 U.S.C. 276c)] the full amounts of wages and bona fide fringe benefits (or cash equivalents thereof) due at time of payment. The payment shall be computed at wage rates not less than those contained in the wage determination of the Secretary of Labor (hereinafter "the wage determination") which is attached hereto and made a part hereof, regardless of any contractual relationship which may be alleged to exist between the contractor or its subcontractors and such laborers and mechanics.

The wage determination (including any additional classifications and wage rates conformed under paragraph 2 of this Section IV and the DOL poster (WH-1321) or Form FHWA-1495) shall be posted at all times by the contractor and its subcontractors at the site of the work in a prominent and accessible place where it can be easily seen by the workers. For the purpose of this Section, contributions made or costs reasonably anticipated for bona fide fringe benefits under Section 1(b)(2) of the Davis-Bacon Act (40 U.S.C. 276a) on behalf of laborers or mechanics are considered wages paid to such laborers or mechanics, subject to the provisions of Section IV, paragraph 3b, hereof. Also, for the purpose of this Section, regular contributions made or costs incurred for more than a weekly period (but not less often than quarterly) under plans, funds, or programs, which cover the particular weekly period, are deemed to be constructively made or incurred during such weekly period. Such laborers and mechanics shall be paid the appropriate wage rate and fringe benefits on the wage determination for the classification of work actually performed, without regard to skill, except as provided in paragraphs 4 and 5 of this Section IV.

- b. Laborers or mechanics performing work in more than one classification may be compensated at the rate specified for each classification for the time actually worked therein, provided, that the employer's payroll records accurately set forth the time spent in each classification in which work is performed.
- c. All rulings and interpretations of the Davis-Bacon Act and related acts contained in 29 CFR 1, 3, and 5 are herein incorporated by reference in this contract.

2. Classification:

- a. The SHA contracting officer shall require that any class of laborers or mechanics employed under the contract, which is not listed in the wage determination, shall be classified in conformance with the wage determination.
- b. The contracting officer shall approve an additional classification, wage rate and fringe benefits only when the following criteria have been met:
 - 1. the work to be performed by the additional classification requested is not performed by a classification in the wage determination;
 - 2. the additional classification is utilized in the area by the construction industry;
 - 3. the proposed wage rate, including any bona fide fringe benefits, bears a reasonable relationship to the wage rates contained in the wage determination; and
 - 4. with respect to helpers, when such a classification prevails in the area in which the work is performed.
- c. If the contractor or subcontractors, as appropriate, the laborers and mechanics (if known) to be employed in the additional classification or

their representatives, and the contracting officer agree on the classification and wage rate (including the amount designated for fringe benefits where appropriate), a report of the action taken shall be sent by the contracting officer to the DOL, Administrator of the Wage and Hour Division, Employment Standards Administration, Washington, D.C. 20210. The Wage and Hour Administrator, or an authorized representative, will approve, modify, or disapprove every additional classification action within 30 days of receipt and so advise the contracting officer or will notify the contracting officer within the 30-day period that additional time is necessary.

- d. In the event the contractor or subcontractors, as appropriate, the laborers or mechanics to be employed in the additional classification or their representatives, and the contracting officer do not agree on the proposed classification and wage rate (including the amount designated for fringe benefits, where appropriate), the contracting officer shall refer the questions, including the views of all interested parties and the recommendation of the contracting officer, to the Wage and Hour Administrator for determination. Said Administrator, or an authorized representative, will issue a determination within 30 days of receipt and so advise the contracting officer or will notify the contracting officer within the 30-day period that additional time is necessary
- e. The wage rate (including fringe benefits where appropriate) determined pursuant to paragraph 2c or 2d of this Section IV shall be paid to all workers performing work in the additional classification from the first day on which work is performed in the classification.

3. Payment of Fringe Benefits:

- a. Whenever the minimum wage rate prescribed in the contract for a class of laborers or mechanics includes a fringe benefit which is not expressed as an hourly rate, the contractor or subcontractors, as appropriate, shall either pay the benefit as stated in the wage determination or shall pay another bona fide fringe benefit or an hourly case equivalent thereof.
- b. If the contractor or subcontractor, as appropriate, does not make payments to a trustee or other third person, he/she may consider as a part of the wages of any laborer or mechanic the amount of any costs reasonably anticipated in providing bona fide fringe benefits under a plan or program, provided, that the Secretary of Labor has found, upon the written request of the contractor, that the applicable standards of the Davis-Bacon Act have been met. The Secretary of Labor may require the contractor to set aside in a separate account assets for the meeting of obligations under the plan or program.

4. Apprentices and Trainees (Programs of the U.S. DOL) and Helpers:

- a. Apprentices:
 - A. Apprentices will be permitted to work at less than the predetermined rate for the work they performed when they are employed pursuant to and individually registered in a bona fide apprenticeship program registered with the DOL, Employment and Training Administration, Bureau of Apprenticeship and Training, or with a State apprenticeship agency recognized by the Bureau, or if a person is employed in his/her first 90 days of probationary employment as an apprentice in such an apprenticeship program, who is not individually registered in the

program, but who has been certified by the Bureau of Apprenticeship and Training or a State apprenticeship agency (where appropriate) to be eligible for probationary employment as an apprentice.

- B. The allowable ratio of apprentices to journeyman-level employees on the job site in any craft classification shall not be greater than the ratio permitted to the contractor as to the entire work force under the registered program. Any employee listed on a payroll at an apprentice wage rate, who is not registered or otherwise employed as stated above, shall be paid not less than the applicable wage rate listed in the wage determination for the classification of work actually performed. In addition, any apprentice performing work on the job site in excess of the ratio permitted under the registered program shall be paid not less than the applicable wage rate on the wage determination for the work actually performed. Where a contractor or subcontractor is performing construction on a project in a locality other than that in which its program is registered, the ratios and wage rates (expressed in percentages of the journeyman-level hourly rate) specified in the contractor's or subcontractor's registered program shall be observed.
 - C. Every apprentice must be paid at not less than the rate specified in the registered program for the apprentice's level of progress, expressed as a percentage of the journeyman-level hourly rate specified in the applicable wage determination. Apprentices shall be paid fringe benefits in accordance with the provisions of the apprenticeship program. If the apprenticeship program does not specify fringe benefits, apprentices must be paid the full amount of fringe benefits listed on the wage determination for the applicable classification. If the Administrator for the Wage and Hour Division determines that a different practice prevails for the applicable apprentice classification, fringes shall be paid in accordance with that determination.
 - D. In the event the Bureau of Apprenticeship and Training, or a State apprenticeship agency recognized by the Bureau, withdraws approval of an apprenticeship program, the contractor or subcontractor will no longer be permitted to utilize apprentices at less than the applicable predetermined rate for the comparable work performed by regular employees until an acceptable program is approved.
- b. Trainees:
- A. Except as provided in 29 CFR 5.16, trainees will not be permitted to work at less than the predetermined rate for the work performed unless they are employed pursuant to and individually registered in a program which has received prior approval, evidenced by formal certification by the DOL, Employment and Training Administration.
 - B. The ratio of trainees to journeyman-level employees on the job site shall not be greater than permitted under the plan approved by the Employment and Training Administration. Any employee listed on the payroll at a trainee rate who is not registered and participating in a training plan approved by the Employment and

Training Administration shall be paid not less than the applicable wage rate on the wage determination for the classification of work actually performed. In addition, any trainee performing work on the job site in excess of the ratio permitted under the registered program shall be paid not less than the applicable wage rate on the wage determination for the work actually performed.

- C. Every trainee must be paid at not less than the rate specified in the approved program for his/her level of progress, expressed as a percentage of the journeyman-level hourly rate specified in the applicable wage determination. Trainees shall be paid fringe benefits in accordance with the provisions of the trainee program. If the trainee program does not mention fringe benefits, trainees shall be paid the full amount of fringe benefits listed on the wage determination unless the Administrator of the Wage and Hour Division determines that there is an apprenticeship program associated with the corresponding journeyman-level wage rate on the wage determination which provides for less than full fringe benefits for apprentices, in which case such trainees shall receive the same fringe benefits as apprentices.
- D. In the event the Employment and Training Administration withdraws approval of a training program, the contractor or subcontractor will no longer be permitted to utilize trainees at less than the applicable predetermined rate for the work performed until an acceptable program is approved.

c. **Helpers:**

Helpers will be permitted to work on a project if the helper classification is specified and defined on the applicable wage determination or is approved pursuant to the conformance procedure set forth in Section IV.2. Any worker listed on a payroll at a helper wage rate, who is not a helper under an approved definition, shall be paid not less than the applicable wage rate on the wage determination for the classification of work actually performed.

5. Apprentices and Trainees (Programs of the U.S. DOT):

Apprentices and trainees working under apprenticeship and skill training programs which have been certified by the Secretary of Transportation as promoting EEO in connection with Federal-aid highway construction programs are not subject to the requirements of paragraph 4 of this Section IV. The straight time hourly wage rates for apprentices and trainees under such programs will be established by the particular programs. The ratio of apprentices and trainees to journeymen shall not be greater than permitted by the terms of the particular program.

6. Withholding:

The SHA shall upon its own action or upon written request of an authorized representative of the DOL withhold, or cause to be withheld, from the contractor or subcontractor under this contract or any other Federal contract with the same

prime contractor, or any other Federally-assisted contract subject to Davis-Bacon prevailing wage requirements which is held by the same prime contractor, as much of the accrued payments or advances as may be considered necessary to pay laborers and mechanics, including apprentices, trainees, and helpers, employed by the contractor or any subcontractor the full amount of wages required by the contract. In the event of failure to pay any laborer or mechanic, including any apprentice, trainee, or helper, employed or working on the site of the work, all or part of the wages required by the contract, the SHA contracting officer may, after written notice to the contractor, take such action as may be necessary to cause the suspension of any further payment, advance, or guarantee of funds until such violations have ceased.

7. Overtime Requirements:

No contractor or subcontractor contracting for any part of the contract work which may require or involve the employment of laborers, mechanics, watchmen, or guards (including apprentices, trainees, and helpers described in paragraphs 4 and 5 above) shall require or permit any laborer, mechanic, watchman, or guard in any workweek in which he/she is employed on such work, to work in excess of 40 hours in such workweek unless such laborer, mechanic, watchman, or guard receives compensation at a rate not less than one-and-one-half times his/her basic rate of pay for all hours worked in excess of 40 hours in such workweek.

8. Violation:

Liability for Unpaid Wages; Liquidated Damages: In the event of any violation of the clause set forth in paragraph 7 above, the contractor and any subcontractor responsible thereof shall be liable to the affected employee for his/her unpaid wages. In addition, such contractor and subcontractor shall be liable to the United States (in the case of work done under contract for the District of Columbia or a territory, to such District or to such territory) for liquidated damages. Such liquidated damages shall be computed with respect to each individual laborer, mechanic, watchman, or guard employed in violation of the clause set forth in paragraph 7, in the sum of \$10 for each calendar day on which such employee was required or permitted to work in excess of the standard work week of 40 hours without payment of the overtime wages required by the clause set forth in paragraph 7.

9. Withholding for Unpaid Wages and Liquidated Damages:

The SHA shall upon its own action or upon written request of any authorized representative of the DOL withhold, or cause to be withheld, from any monies payable on account of work performed by the contractor or subcontractor under any such contract or any other Federal contract with the same prime contractor, or any other Federally-assisted contract subject to the Contract Work Hours and Safety Standards Act, which is held by the same prime contractor, such sums as may be determined to be necessary to satisfy any liabilities of such contractor or subcontractor for unpaid wages and liquidated damages as provided in the clause set forth in paragraph 8 above.

V. STATEMENTS AND PAYROLLS

(Applicable to all Federal-aid construction contracts exceeding \$2,000 and to all related subcontracts, except for projects located on roadways classified as local roads or rural collectors, which are exempt.)

1. **Compliance with Copeland Regulations (29 CFR 3):**

The contractor shall comply with the Copeland Regulations of the Secretary of Labor which are herein incorporated by reference.

2. **Payrolls and Payroll Records:**

- a. Payrolls and basic records relating thereto shall be maintained by the contractor and each subcontractor during the course of the work and preserved for a period of 3 years from the date of completion of the contract for all laborers, mechanics, apprentices, trainees, watchmen, helpers, and guards working at the site of the work.
- b. The payroll records shall contain the name, social security number, and address of each such employee; his or her correct classification; hourly rates of wages paid (including rates of contributions or costs anticipated for bona fide fringe benefits or cash equivalent thereof the types described in Section 1(b)(2)(B) of the Davis Bacon Act); daily and weekly number of hours worked; deductions made; and actual wages paid. In addition, for Appalachian contracts, the payroll records shall contain a notation indicating whether the employee does, or does not, normally reside in the labor area as defined in Attachment A, paragraph 1. Whenever the Secretary of Labor, pursuant to Section IV, paragraph 3b, has found that the wages of any laborer or mechanic include the amount of any costs reasonably anticipated in providing benefits under a plan or program described in Section 1(b)(2)(B) of the Davis Bacon Act, the contractor and each subcontractor shall maintain records which show that the commitment to provide such benefits is enforceable, that the plan or program is financially responsible, that the plan or program has been communicated in writing to the laborers or mechanics affected, and show the cost anticipated or the actual cost incurred in providing benefits. Contractors or subcontractors employing apprentices or trainees under approved programs shall maintain written evidence of the registration of apprentices and trainees, and ratios and wage rates prescribed in the applicable programs.
- c. Each contractor and subcontractor shall furnish, each week in which any contract work is performed, to the SHA resident engineer a payroll of wages paid each of its employees (including apprentices, trainees, and helpers, described in Section IV, paragraphs 4 and 5, and watchmen and guards engaged on work during the preceding weekly payroll period). The payroll submitted shall set out accurately and completely all of the information required to be maintained under paragraph 2b of this Section V. This information may be submitted in any form desired. Optional Form WH-347 is available for this purpose and may be purchased from the Superintendent of Documents (Federal stock number 029-005-0014-1), U.S. Government Printing Office, Washington, D.C. 20402.

The prime contractor is responsible for the submission of copies of payrolls by all subcontractors.

- d. Each payroll submitted shall be accompanied by a "Statement of Compliance," signed by the contractor or subcontractor or his/her agent who pays or supervises the payment of the persons employed under the contract and shall certify the following:
 - 1. that the payroll for the payroll period contains the information required to be maintained under paragraph 2b of this Section V and that such information is correct and complete;
 - 2. that such laborer or mechanic (including each helper, apprentice, and trainee) employed on the contract during the payroll period has been paid the full weekly wages earned, without rebate, either directly or indirectly, and that no deductions have been made either directly or indirectly from the full wages earned, other than permissible deductions as set forth in the Regulations, 29 CFR 3;
 - 3. that each laborer or mechanic has been paid not less than the applicable wage rate and fringe benefits or cash equivalent for the classification of work performed, as specified in the applicable wage determination incorporated into the contract.
- e. The weekly submission of a properly executed certification set forth on the reverse side of Optional Form WH-347 shall satisfy the requirement for submission of the "Statement of Compliance" required by paragraph 2d of this Section V.
- f. The falsification of any of the above certifications may subject the contractor to civil or criminal prosecution under 18 U.S.C. 1001 and 31 U.S.C. 231.
- g. The contractor or subcontractor shall make the records required under paragraph 2b of this Section V available for inspection, copying, or transcription by authorized representatives of the SHA, the FHWA, or the DOL, and shall permit such representatives to interview employees during working hours on the job. If the contractor or subcontractor fails to submit the required records or to make them available, the SHA, the FHWA, the DOL, or all may, after written notice to the contractor, sponsor, applicant, or owner, take such actions as may be necessary to cause the suspension of any further payment, advance, or guarantee of funds. Furthermore, failure to submit the required records upon request or to make such records available may be grounds for debarment action pursuant to 29 CFR 5.12.

VI. **RECORD OF MATERIALS, SUPPLIES, AND LABOR**

- 1. On all Federal-aid contracts on the National Highway System, except those which provide solely for the installation of protective devices at railroad grade crossings, those which are constructed on a force account or direct labor basis, highway beautification contracts, and contracts for which the total final construction cost for roadway and bridge is less than \$1,000,000 (23 CFR 635) the contractor shall:

- a. Become familiar with the list of specific materials and supplies contained in Form FHWA-47, "Statement of Materials and Labor Used by Contractor of Highway Construction Involving Federal Funds," prior to the commencement of work under this contract.
 - b. Maintain a record of the total cost of all materials and supplies purchased for and incorporated in the work, and also of the quantities of those specific materials and supplies listed on Form FHWA-47, and in the units shown on Form FHWA-47.
 - c. Furnish, upon the completion of the contract, to the SHA resident engineer on Form FHWA-47 together with the data required in paragraph 1b relative to materials and supplies, a final labor summary of all contract work indicating the total hours worked and the total amount earned.
2. At the prime contractor's option, either a single report covering all contract work or separate reports for the contractor and for each subcontract shall be submitted.

VII. SUBLETTING OR ASSIGNING THE CONTRACT

1. The contractor shall perform with its own organization contract work amounting to not less than 30 percent (or a greater percentage if specified elsewhere in the contract) of the total original contract price, excluding any specialty items designated by the State. Specialty items may be performed by subcontract and the amount of any such specialty items performed may be deducted from the total original contract price before computing the amount of work required to be performed by the contractor's own organization (23 CFR 635).

- a. "Its own organization" shall be construed to include only workers employed and paid directly by the prime contractor and equipment owned or rented by the prime contractor, with or without operators. Such term does not include employees or equipment of a subcontractor, assignee, or agent of the prime contractor.
- b. "Specialty Items" shall be construed to be limited to work that requires highly specialized knowledge, abilities, or equipment not ordinarily available in the type of contracting organizations qualified and expected to bid on the contract as a whole and in general are to be limited to minor components of the overall contract.
- c. The contract amount upon which the requirements set forth in paragraph 1 of Section VII is computed includes the cost of material and manufactured products which are to be purchased or produced by the contractor under the contract provisions.
- d. The contractor shall furnish (a) a competent superintendent or supervisor who is employed by the firm, has full authority to direct performance of the work in accordance with the contract requirements, and is in charge of all construction operations (regardless of who performs the work) and (b) such other of its own organizational resources (supervision, management, and engineering services) as the SHA contracting officer determines is necessary to assure the performance of the contract.
- e. No portion of the contract shall be sublet, assigned or otherwise disposed of except with the written consent of the SHA contracting officer, or authorized representative, and such consent when given shall

not be construed to relieve the contractor of any responsibility for the fulfillment of the contract. Written consent will be given only after the SHA has assured that each subcontract is evidenced in writing and that it contains all pertinent provisions and requirements of the prime contract.

VIII. SAFETY: ACCIDENT PREVENTION

1. In the performance of this contract the contractor shall comply with all applicable Federal, State, and local laws governing safety, health, and sanitation (23 CFR 635). The contractor shall provide all safeguards, safety devices and protective equipment and take any other needed actions as it determines, or as the SHA contracting officer may determine, to be reasonably necessary to protect the life and health of employees on the job and the safety of the public and to protect property in connection with the performance of the work covered by the contract.
2. It is a condition of this contract, and shall be made a condition of each subcontract, which the contractor enters into pursuant to this contract, that the contractor and any subcontractor shall not permit any employee, in performance of the contract, to work in surroundings or under conditions which are unsanitary, hazardous or dangerous to his/her health or safety, as determined under construction safety and health standards (29 CFR 1926) promulgated by the Secretary of Labor, in accordance with Section 107 of the Contract Work Hours and Safety Standards Act (40 U.S.C. 333).
3. Pursuant to 29 CFR 1926.3, it is a condition of this contract that the Secretary of Labor or authorized representative thereof, shall have right of entry to any site of contract performance to inspect or investigate the matter of compliance with the construction safety and health standards and to carry out the duties of the Secretary under Section 107 of the Contract Work Hours and Safety Standards Act (40 U.S.C. 333).

IX. FALSE STATEMENTS CONCERNING HIGHWAY PROJECTS

In order to assure high quality and durable construction in conformity with approved plans and specifications and a high degree of reliability on statements and representations made by engineers, contractors, suppliers, and workers on Federal-aid highway projects, it is essential that all persons concerned with the project perform their functions as carefully, thoroughly, and honestly as possible. Willful falsification, distortion, or misrepresentation with respect to any facts related to the project is a violation of Federal law. To prevent any misunderstanding regarding the seriousness of these and similar acts, the following notice shall be posted on each Federal-aid highway project (23 CFR 635) in one or more places where it is readily available to all persons concerned with the project:

NOTICE TO ALL PERSONNEL ENGAGED ON FEDERAL-AID HIGHWAY PROJECTS

18 U.S.C. 1020 reads as follows:

"Whoever, being an officer, agent, or employee of the United States, or of any State or Territory, or whoever, whether a person, association, firm, or corporation, knowingly makes any false statement, false representation, or false report as to the character, quality, quantity, or cost of the material used or to be used, or the quantity or quality of the work performed or to be performed, or the cost thereof in connection with the submission of plans, maps, specifications, contracts, or costs of construction on any highway or related project submitted for approval to the Secretary of Transportation; or

Whoever knowingly makes any false statement, false representation, false report or false claim with respect to the character, quality, quantity, or cost of any work performed or to be performed, or materials furnished or to be furnished, in connection with the construction of any highway or related project approved by the Secretary of Transportation; or

Whoever knowingly makes any false statement or false representation as to material fact in any statement, certificate, or report submitted pursuant to provisions of the Federal-aid Roads Act approved July 1, 1916, (39 Stat. 355), as amended and supplemented;

Shall be fined not more than \$10,000 or imprisoned not more than 5 years or both."

X. IMPLEMENTATION OF CLEAN AIR ACT AND FEDERAL WATER POLLUTION CONTROL ACT

(Applicable to all Federal-aid construction contracts and to all related subcontracts of \$100,000 or more.)

By submission of this bid or the execution of this contract, or subcontract, as appropriate, the bidder, Federal-aid construction contractor, or subcontractor, as appropriate, will be deemed to have stipulated as follows:

1. That any facility that is or will be utilized in the performance of this contract, unless such contract is exempt under the Clean Air Act, as amended (42 U.S.C. 1857 et seq., as amended by Pub.L. 91-604), and under the Federal Water Pollution Control Act, as amended (33 U.S.C. 1251 et seq., as amended by Pub.L. 92-500), Executive Order 11738, and regulations in implementation thereof (40 CFR 15) is not listed, on the date of contract award, on the U.S. Environmental Protection Agency (EPA) List of Violating Facilities pursuant to 40 CFR 15.20.
2. That the firm agrees to comply and remain in compliance with all the requirements of Section 114 of the Clean Air Act and Section 308 of the Federal Water Pollution Control Act and all regulations and guidelines listed there under.
3. That the firm shall promptly notify the SHA of the receipt of any communication from the Director, Office of Federal Activities, EPA, indicating that a facility that is or will be utilized for the contract is under consideration to be listed on the EPA List of Violating Facilities.
4. That the firm agrees to include or cause to be included the requirements of paragraph 1 through 4 of this Section X in every nonexempt subcontract, and further agrees to take such action as the government may direct as a means of enforcing such requirements.

XI. CERTIFICATION REGARDING DEBARMENT, SUSPENSION, INELIGIBILITY AND VOLUNTARY EXCLUSION

1. Instructions for Certification - Primary Covered Transactions:

(Applicable to all Federal-aid contracts - 49 CFR 29)

- a. By signing and submitting this proposal, the prospective primary participant is providing the certification set out below.
- b. The inability of a person to provide the certification set out below will not necessarily result in denial of participation in this covered transaction.

The prospective participant shall submit an explanation of why it cannot provide the certification set out below. The certification or explanation will be considered in connection with the department or agency's determination whether to enter into this transaction. However, failure of the prospective primary participant to furnish a certification or an explanation shall disqualify such a person from participation in this transaction.

- c. The certification in this clause is a material representation of fact upon which reliance was placed when the department or agency determined to enter into this transaction. If it is later determined that the prospective primary participant knowingly rendered an erroneous certification, in addition to other remedies available to the Federal Government, the department or agency may terminate this transaction for cause of default.
- d. The prospective primary participant shall provide immediate written notice to the department or agency to whom this proposal is submitted if any time the prospective primary participant learns that its certification was erroneous when submitted or has become erroneous by reason of changed circumstances.
- e. The terms "covered transaction," "debarred," "suspended," "ineligible," "lower tier covered transaction," "participant," "person," "primary covered transaction," "principal," "proposal," and "voluntarily excluded," as used in this clause, have the meanings set out in the Definitions and Coverage sections of rules implementing Executive Order 12549. You may contact the department or agency to which this proposal is submitted for assistance in obtaining a copy of those regulations.
- f. The prospective primary participant agrees by submitting this proposal that, should the proposed covered transaction be entered into, it shall not knowingly enter into any lower tier covered transaction with a person who is debarred, suspended, declared ineligible, or voluntarily excluded from participation in this covered transaction, unless authorized by the department or agency entering into this transaction.
- g. The prospective primary participant further agrees by submitting this proposal that it will include the clause titled "Certification Regarding Debarment, Suspension, Ineligibility and Voluntary Exclusion-Lower Tier Covered Transaction," provided by the department or agency entering into this covered transaction, without modification, in all lower tier covered transactions and in all solicitations for lower tier covered transactions.
- h. A participant in a covered transaction may rely upon a certification of a prospective participant in a lower tier covered transaction that is not debarred, suspended, ineligible, or voluntarily excluded from the covered transaction, unless it knows that the certification is erroneous. A participant may decide the method and frequency by which it determines the eligibility of its principals. Each participant may, but is not required to, check the nonprocurement portion of the "Lists of Parties Excluded From Federal Procurement or Nonprocurement Programs" (Nonprocurement List) which is compiled by the General Services Administration.
- i. Nothing contained in the foregoing shall be construed to require establishment of a system of records in order to render in good faith the certification required by this clause.

The knowledge and information of participant is not required to exceed that which is normally possessed by a prudent person in the ordinary course of business dealings.

- j. Except for transactions authorized under paragraph f of these instructions, if a participant in a covered transaction knowingly enters into a lower tier covered transaction with a person who is suspended, debarred, ineligible, or voluntarily excluded from participation in this transaction, in addition to other remedies available to the Federal Government, the department or agency may terminate this transaction for cause or default.

* * * * *

Certification Regarding Debarment, Suspension, Ineligibility and Voluntary Exclusion--Primary Covered Transactions

1. The prospective primary participant certifies to the best of its knowledge and belief, that it and its principals:
 - a. Are not presently debarred, suspended, proposed for debarment, declared ineligible, or voluntarily excluded from covered transactions by any Federal department or agency;
 - b. Have not within a 3-year period preceding this proposal been convicted of or had a civil judgment rendered against them for commission of fraud or a criminal offense in connection with obtaining, attempting to obtain, or performing a public (Federal, State or local) transaction or contract under a public transaction; violation of Federal or State antitrust statutes or commission of embezzlement, theft, forgery, bribery, falsification or destruction of records, making false statements, or receiving stolen property;
 - c. Are not presently indicted for or otherwise criminally or civilly charged by a governmental entity (Federal, State or local) with commission of any of the offenses enumerated in paragraph 1b of this certification; and
 - d. Have not within a 3-year period preceding this application/proposal had one or more public transactions (Federal, State or local) terminated for cause or default.
2. Where the prospective primary participant is unable to certify to any of the statements in this certification, such prospective participant shall attach an explanation to this proposal.

* * * * *

1. Instructions for Certification - Lower Tier Covered Transactions:

(Applicable to all subcontracts, purchase orders and other lower tier transactions of \$25,000 or more - 49 CFR 29)

- a. By signing and submitting this proposal, the prospective lower tier is providing the certification set out below.

- b. The certification in this clause is a material representation of fact upon which reliance was placed when this transaction was entered into. If it is later determined that the prospective lower tier participant knowingly rendered an erroneous certification, in addition to other remedies available to the Federal Government, the department, or agency with which this transaction originated may pursue available remedies, including suspension and/or debarment.
- c. The prospective lower tier participant shall provide immediate written notice to the person to which this proposal is submitted if at any time the prospective lower tier participant learns that its certification was erroneous by reason of changed circumstances.
- d. The terms "covered transaction," "debarred," "suspended," "ineligible," "primary covered transaction," "participant," "person," "principal," "proposal," and "voluntarily excluded," as used in this clause, have the meanings set out in the Definitions and Coverage sections of rules implementing Executive Order 12549. You may contact the person to which this proposal is submitted for assistance in obtaining a copy of those regulations.
- e. The prospective lower tier participant agrees by submitting this proposal that, should the proposed covered transaction be entered into, it shall not knowingly enter into any lower tier covered transaction with a person who is debarred, suspended, declared ineligible, or voluntarily excluded from participation in this covered transaction, unless authorized by the department or agency with which this transaction originated.
- f. The prospective lower tier participant further agrees by submitting this proposal that it will include this clause titled "Certification Regarding Debarment, Suspension, Ineligibility and Voluntary Exclusion-Lower Tier Covered Transaction," without modification, in all lower tier covered transactions and in all solicitations for lower tier covered transactions.
- g. A participant in a covered transaction may rely upon a certification of a prospective participant in a lower tier covered transaction that is not debarred, suspended, ineligible, or voluntarily excluded from the covered transaction, unless it knows that the certification is erroneous. A participant may decide the method and frequency by which it determines the eligibility of its principals. Each participant may, but is not required to, check the Nonprocurement List.
- h. Nothing contained in the foregoing shall be construed to require establishment of a system of records in order to render in good faith the certification required by this clause. The knowledge and information of participant is not required to exceed that which is normally possessed by a prudent person in the ordinary course of business dealings.
- i. Except for transactions authorized under paragraph e of these instructions, if a participant in a covered transaction knowingly enters into a lower tier covered transaction with a person who is suspended, debarred, ineligible, or voluntarily excluded from participation in this transaction, in addition to other remedies available to the Federal Government, the department or agency with which this transaction originated may pursue available remedies, including suspension and/or debarment.

* * * * *

**Certification Regarding Debarment, Suspension, Ineligibility and Voluntary
Exclusion--Lower Tier Covered Transactions:**

0. The prospective lower tier participant certifies, by submission of this proposal, that neither it nor its principals is presently debarred, suspended, proposed for debarment, declared ineligible, or voluntarily excluded from participation in this transaction by any Federal department or agency.
1. Where the prospective lower tier participant is unable to certify to any of the statements in this certification, such prospective participant shall attach an explanation to this proposal.

* * * * *

VII. CERTIFICATION REGARDING USE OF CONTRACT FUNDS FOR LOBBYING

(Applicable to all Federal-aid construction contracts and to all related subcontracts which exceed \$100,000 - 49 CFR 20)

1. The prospective participant certifies, by signing and submitting this bid or proposal, to the best of his or her knowledge and belief, that:
 - a. No Federal appropriated funds have been paid or will be paid, by or on behalf of the undersigned, to any person for influencing or attempting to influence an officer or employee of any Federal agency, a Member of Congress, an officer or employee of Congress, or an employee of a Member of Congress in connection with the awarding of any Federal contract, the making of any Federal grant, the making of any Federal loan, the entering into of any cooperative agreement, and the extension, continuation, renewal, amendment, or modification of any Federal contract, grant, loan, or cooperative agreement.
 - b. If any funds other than Federal appropriated funds have been paid or will be paid to any person for influencing or attempting to influence an officer or employee of any Federal agency, a Member of Congress, an officer or employee of Congress, or an employee of a Member of Congress in connection with this Federal contract, grant, loan, or cooperative agreement, the undersigned shall complete and submit Standard Form-LLL, "Disclosure Form to Report Lobbying," in accordance with its instructions.
2. This certification is a material representation of fact upon which reliance was placed when this transaction was made or entered into. Submission of this certification is a prerequisite for making or entering into this transaction imposed by 31 U.S.C. 1352. Any person who fails to file the required certification shall be subject to a civil penalty of not less than \$10,000 and not more than \$100,000 for each such failure.
3. The prospective participant also agrees by submitting his or her bid or proposal that he or she shall require that the language of this certification be included in all lower tier subcontracts, which exceed \$100,000 and that all such recipients shall certify and disclose accordingly.



United States Department of Transportation - Federal Highway Administration - Infrastructure

12-19-94

APPENDIX A
NOTICE TO CONTRACTORS
COMPLIANCE WITH TITLE VI OF THE CIVIL RIGHTS ACT OF 1964
FOR
FEDERAL-AID CONTRACTS

During the performance of this Contract, the Contractor, for itself, its assignees and successors in interest (hereinafter referred to as the "Contractor"), agrees as follows:

1. Compliance with Regulations: The Contractor will comply with the Regulations of the Department of Transportation relative to nondiscrimination in Federally-assisted programs of the Department of Transportation (Title 49, Code of Federal Regulations, Part 21, hereinafter referred to as the "Regulations"), which are herein incorporated by reference and made a part of the Contract.
2. Nondiscrimination: The Contractor, with regard to the work performed by it afterward and prior to completion of the contract work, will not discriminate on the ground of race, color, sex, or national origin in the selection and retention of subcontracts including procurements of materials and leases of equipment. The Contractor will not participate either directly or indirectly in the discrimination prohibited by Section 21.5 of the Regulations, including employment practices when contract covers a program set forth in Appendix B of the Regulations. In addition, the Contractor will not participate either directly or indirectly in discrimination prohibited by 23 CFR 710.405 (b).
3. Solicitations for subcontracts, including procurements of materials and equipment: In all solicitations, either by competitive bidding or negotiation made by the Contractor for work to be performed under a subcontract, including procurements of materials or equipment, each potential subcontractor or supplier shall be notified by the Contractor of the Contractor's obligations under this Contract and the Regulations relative to nondiscrimination on the ground of race, color, national origin or sex.
4. Information and Reports: The Contractor will provide all information and reports required by the Regulations, or orders and instructions issued pursuant thereto, and will permit access to its books, records, accounts, other sources of information, and its facilities as may be determined by the Department of

A-1

Transportation or the Federal Highway Administration to be pertinent to ascertain compliance with such Regulations, orders and instructions. Where any information required of a Contractor is in the exclusive possession of another who fails or refuses to furnish this information, the Contractor shall so certify to the Department of Transportation, or the Federal Highway Administration as appropriate, and shall set forth what efforts it has made to obtain the information.

5. Sanctions for Noncompliance: In the event of the Contractor's noncompliance with the nondiscrimination provisions of this Contract, the Department of Transportation shall impose such Contract sanctions as it or the Federal Highway Administration may determine to be appropriate, including, but not limited to:

- (a) withholding of payments to the Contractors under the Contract until the Contractor complies, and/or
- (b) Cancellation, termination or suspension of the Contract, in whole or in part.

6. Incorporation of Provisions: The Contractor will include the provisions of paragraph (1) through (6) in every subcontract, including procurements of materials and leases of equipment, unless exempt by the Regulations, orders or instruction issued pursuant thereto. The Contractor will take such action with respect to any subcontract or procurement as the Department of Transportation or the Federal Highway Administration may direct as a means of enforcing such provisions including sanctions for noncompliance. Provided, however, that in the event a Contractor becomes involved in, or is threatened with, litigation with a subcontractor or supplier as result of such direction, the Contractor may request the State to enter into such litigation to protect the interests of the State, and, in addition, the Contractor may request the United States to enter into such litigation to protect the interest of the United States.

**DEPARTMENT OF TRANSPORTATION
STATE OF GEORGIA**

U. S. Department of Labor

GENERAL WAGE DECISION NO. GA080009 07/25/2008 GA9

Superseded General Wage Decision No. GA20070009

State: GEORGIA

County(ies): BUTTS, CHEROKEE, CLAYTON, COBB, COWETA, DEKALB,
DOUGLAS, FAYETTE, FORSYTH, FULTON, GWINNETT, HENRY,
NEWTON, PAULDING ROCKDALE, SPALDING AND WALTON

Construction Type: Highway

Construction

Description: HIGHWAY CONSTRUCTION PROJECTS (excluding tunnels, building structures in rest area projects, and railroad construction; bascule, suspension, and spandrel arch bridges; bridges designed for commercial navigation; bridges involving marine construction; other major bridges).

Modification Number	Publication Date
0	02/08/2008
1	07/25/2008

SUGA 1990-008 05/01/1990

	RATES	FRINGES
ASPHALT RAKER	8.00	
CARPENTER.....	9.03	
CONCRETE FINISHER	8.65	
ELECTRICIAN.....	17.01	
FLAGGER.....	7.19	
FORM SETTER (Road).....	7.73	
GUARDRAIL ERECTOR	8.95	
IRONWORKER (Reinforcing)	11.21	
IRONWORKER (Structural).....	11.01	
LABORER	6.74	
MASON (Structures).....	9.11	
PAINTER	9.65	
PILEDRIVER LEAD PERSON.....	10.14	
PIPELAYER	8.18	
POWER EQUIPMENT OPERATOR:		
Asphalt Distributor	8.79	
Asphalt Paver	8.91	
Backhoe	9.39	
Bulldozer	8.97	
Concrete Paver	8.92	
Crane	10.67	
Dragline.....	10.07	
Drill Operator	10.95	
Loader.....	9.30	

**DEPARTMENT OF TRANSPORTATION
STATE OF GEORGIA**

Traffic Controller (Barricades, Traffic Lines and Detours)	7.28
Grade Checker	6.86
Hydro Seeder	8.00
Mechanic	10.51
Milling Machine	11.97
Motor Grader Operator	10.27
Motor Grade Operator (fine grade)	9.60
Oiler - greaser	10.07
Scrapers	8.27
Pavement striping operator	6.55
Roller	8.09
Roller operator (finish)	8.58
Screed - asphalt	8.46
Sweeper	9.25
Shovel	9.19
Tractor operator (utility)	8.00
TRUCK DRIVERS:	
Single rear axle	6.70
Multi rear axle	7.50
Heavy duty	9.05
WELDER	10.87

GENERAL WAGE DECISION NO. GA080010 07/25/2008 GA10

Superseded General Wage Decision No. GA20070010

State: GEORGIA

County(ies): BANKS, BARTOW, CHATTOOGA, DAWSON, ELBERT, FANNIN, FLOYD,
FRANKLIN, GILMER, GORDON, HABERSHAM, HALL, HARALSON,
HART, LUMPKIN, MURRAY, PICKENS, POLK, RABUN, STEPHENS,
TOWNS, UNION, WHITE, WHITFIELD

Construction Type: Highway

Construction

Description: HIGHWAY CONSTRUCTION PROJECTS (excluding tunnels, building
structures in rest area projects, and railroad construction; bascule, suspension,
and spandrel arch bridges; bridges designed for commercial navigation; bridges
involving marine construction; and other major bridges).

Modification Number	Publication Date
0	02/09/2007
1	07/25/2008

SUGA 1990-003 05/01/1990

	RATES	FRINGES
ASPHALT RAKER	7.51	
CARPENTER	8.38	
CONCRETE FINISHER	8.05	

**DEPARTMENT OF TRANSPORTATION
STATE OF GEORGIA**

FLAGGER.....	6.55
FORM SETTER (ROAD).....	7.10
GUARDRAIL ERECTOR.....	9.13
IRONWORKER, REINFORCING.....	11.35
LABORER.....	6.55
MASON (STRUCTURES).....	7.74
PIPELAYER.....	7.17
POWER EQUIPMENT OPERATORS:	
Asphalt distributor.....	8.18
Asphalt paver.....	8.39
Backhoe.....	8.85
Bulldozer.....	8.48
Crane.....	9.44
Dragline.....	9.91
Drill Operator.....	7.48
Loader.....	7.89
Mechanic.....	9.31
Milling machine.....	8.75
Motor grader (fine grade).....	9.40
Motor grader operator.....	9.07
Oiler - greaser.....	8.09
Power tool operator.....	7.55
Scraper.....	8.05
Screed - asphalt.....	7.71
Striping Machine.....	6.55
Sweeper.....	6.55
Roller.....	7.10
Roller operator (finish).....	8.44
Tractor (utility).....	8.00
TRUCK DRIVERS:	
Single Rear Axle.....	6.55
Multi Rear Axle.....	7.08
Heavy Duty.....	9.50
WELDER.....	10.12

GENERAL WAGE DECISION NO. GA080011 07/25/2008 GA11

Supersedes General Wage Decision No. GA20070011

State: GEORGIA

County(ies): APPLING, ATKINSON, BACON, BAKER, BALDWIN, BEN HILL, BERRIEN, BLECKLEY, BRANTLEY, BROOKS, BRYAN, BULLOCH, BURKE, CALHOUN, CAMDEN, CANDLER, CARROLL, CHARLTON, CLAY, CLINCH, COFFEE, COLQUITT, COOK, CRAWFORD, CRISP, DECATUR, DODGE, DOOLY, EARLY, ECHOLS, EMANUEL, EVANS, GLASCOCK, GLYNN, GRADY, GREENE, HANCOCK, HARRIS, HEARD, IRWIN, JASPER, JEFF DAVIS, JEFFERSON, JENKINS, JOHNSON, LAMAR, LANIER, LAURENS, LIBERTY, LINCOLN, LONG LOWNDES, MACON, MARION, MCINTOSH, MERIWETHER, MILLER,

**DEPARTMENT OF TRANSPORTATION
STATE OF GEORGIA**

MITCHELL, MONROE, MONTGOMERY, MORGAN, OGLETHORPE, PIERCE,
PIKE, PULASKI, PUTNAM, QUITMAN, RANDOLPH, SCHLEY, SCREVEN,
SEMINOLE, STEWART, SUMTER, TALBOT, TALIAFERRO, TATTNALL,
TAYLOR, TELFAIR, TERRELL, THOMAS, TIFT, TOOMBS, TREUTLEN, TROUP,
TURNER, TWIGGS, UPSON, WARE, WARREN, WASHINGTON, WAYNE,
WEBSTER, WHEELER, WILCOX, WILKES, WILKINSON, WORTH

Construction Type: Highway

Construction

Description: HIGHWAY CONSTRUCTION PROJECTS (excluding tunnels, building structures in rest area projects, and railroad construction; bascule, suspension, and spandrel arch bridges; bridges designed for commercial navigation; bridges involving marine construction; and other major bridges).

Modification Number	Publication Date
0	02/09/2007
1	07/25/2008

SUGA 1990-004 05/01/1990

	RATES	FRINGES
ASPHALT RAKER.....	6.55	
CARPENTER.....	8.46	
MASON (STRUCTURES).....	8.54	
CONCRETE FINISHER.....	7.45	
FORM SETTER (ROAD).....	6.66	
FLAGGER.....	6.55	
GUARDRAIL ERECTOR.....	10.71	
GRADE CHECKER.....	6.55	
IRONWORKER (REINFORCING).....	10.54	
LABORERS:		
General laborer.....	6.55	
Pipelayer.....	6.55	
POWER EQUIPMENT OPERATORS:		
Asphalt distributor.....	6.73	
Asphalt paver.....	6.83	
Backhoe.....	8.11	
Bulldozer.....	7.66	
Concrete Curb Machine.....	6.60	
Concrete Paver.....	8.36	
Crane.....	9.46	
Dragline.....	8.80	
Loader.....	7.31	
Mechanic.....	8.92	
Milling Machine.....	8.49	
Mixer Box Operator.....	6.55	
Motor grade (fine grade).....	8.55	
Motor grader.....	8.64	
Scraper.....	7.16	
Pavement striping operator.....	6.57	
Oiler - greaser.....	6.55	
Roller.....	6.55	

**DEPARTMENT OF TRANSPORTATION
STATE OF GEORGIA**

Roller (finish).....	6.55
Screed - asphalt	7.42
Shovel.....	9.26
Sign erector	6.55
Sweeper/broom	6.55
Stone spreader	6.55
Tractor (utility).....	6.55
POWER TOOL OPERATOR	6.55
TRAFFIC SIGNAL INSTALLER	6.55
TRAFFIC CONTROLLER (Barricades, traffic lines and detours).....	6.97
TRUCK DRIVERS:	
Single/multi rear axle.....	6.55
Heavy duty	6.55
WELDERS - Receive rate prescribed for craft performing operation to which welding is incidental.	

GENERAL WAGE DECISION NO. GA080012 07/25/2008 GA12

Superseded General Wage Decision No. GA20070012

State: GEORGIA

Construction type: Highway

County(ies): CHATHAM, EFFINGHAM

Construction

Description: HIGHWAY CONSTRUCTION PROJECTS (excluding tunnels, building structures in rest area projects, and railroad construction; bascule, suspension, and spandrel arch bridges; bridges designed for commercial navigation; bridges involving marine construction; and other major bridges).

Modification Number Publication Date

0 02/09/2007

1 07/25/2008

SUGA 1990-005 05/01/1990

	RATES	FRINGES
ASPHALT RAKER	6.92	
CARPENTER.....	10.83	
CONCRETE FINISHER	8.61	
ELECTRICIAN.....	14.95	
IRONWORKER, REINFORCING	13.60	
LABORER	6.55	
PAINTER.....	12.00	
PILEDRIVER.....	10.19	
POWER EQUIPMENT OPERATORS:		
Asphalt distributor.....	7.88	
Asphalt Paver	8.23	
Backhoe operator.....	10.03	
Bulldozer operator.....	9.44	
Crane	13.36	

**DEPARTMENT OF TRANSPORTATION
STATE OF GEORGIA**

Loader.....	9.99
Mechanic	10.66
Motor grade operator (fine grade)	10.70
Striping machine operator	6.55
Roller.....	7.98
Screed - asphalt	7.69
TRUCK DRIVERS:	
Single-rear axle.....	6.55
Multi-rear axle.....	7.69
WELDER	10.00

GENERAL WAGE DECISION No. GA080024 07/25/2008 GA24

Superseded General Wage Decision No. GA20070024

State: GEORGIA

Construction type: Highway

County(ies): BIBB, HOUSTON, JONES, PEACH

Construction

Description: HIGHWAY CONSTRUCTION PROJECTS (excluding tunnels, building structures in rest area projects, and railroad construction; bascule, suspension, and spandrel arch bridges; bridges designed for commercial navigation; other major bridges).

Modification Number Publication Date

 00 02/09/2007

 01 07/25/2008

SUGA 1990-006 05/01/1990

	RATES	FRINGES
ASPHALT RAKER	6.55	
CARPENTER	8.48	
CONCRETE FINISHER	7.68	
FLAGGER.....	6.55	
FORM SETTER (ROAD).....	6.67	
LABORER	6.55	
PIPELAYER	6.82	
POWER EQUIPMENT OPERATORS:		
Asphalt Distributor	6.77	
Asphalt Paver	7.22	
Backhoe.....	8.24	
Bulldozer	7.73	
Crane	10.00	
Loader.....	6.93	
Mechanic	9.15	
Motor Grade Operator.....	9.09	

**DEPARTMENT OF TRANSPORTATION
STATE OF GEORGIA**

Oiler - Greaser	6.68
Striping Machine Operator	6.55
Rollers	6.55
Tractors (Utility).....	6.55
TRAFFIC CONTROLLER	6.55
TRUCK DRIVERS	
Single rear axle.....	6.55
Multi rear axle	6.55
WELDERS - Receive rate prescribed for craft performing operation to which welding is incidental.	

GENERAL WAGE DECISION NO. GA080025 07/25/2008 GA25

Superseded General Wage Decision No. GA20070025

State: GEORGIA

Construction type: Highway

County(ies): CATOOSA, DADE, WALKER

Construction

Description: HIGHWAY CONSTRUCTION PROJECTS (excluding tunnels, building structures in rest area projects, and railroad construction; bascule, suspension, and spandrel arch bridges; bridges designed for commercial navigation; bridges involving marine construction; other major bridges).

Modification Number	Publication Date
0	02/09/2007
1	07/25/2008

SUGA1990-007 05/01/1990

	RATES	FRINGES
ASPHALT RAKER	7.66	
CARPENTER.....	9.75	
CONCRETE FINISHER	7.42	
LABORER	6.55	
POWER EQUIPMENT OPERATORS:		
Asphalt distributor.....	7.81	
Asphalt paver.....	8.18	
Backhoe	9.12	
Bulldozer	8.87	
Crane	9.00	
Loader.....	7.82	
Mechanic	11.18	
Motor grade operator (fine grade).....	10.52	
Roller.....	6.67	
TRUCK DRIVERS:		
Single-rear axle.....	6.65	
Multi-rear axle.....	7.38	

**DEPARTMENT OF TRANSPORTATION
STATE OF GEORGIA**

WELDERS - Receive rate prescribed for craft performing operation to which welding is incidental.

GENERAL WAGE DECISION NO. GA080027 7/25/2008 GA27

Superseded General Wage Decision No. GA20070027

State: GEORGIA

Construction type: Highway

County(ies): CHATTAHOOCHEE, MUSCOGEE

Construction

Description: HIGHWAY CONSTRUCTION PROJECTS (excluding tunnels, building structures in rest area projects, and railroad construction; bascule, suspension, and spandrel arch bridges; bridges designed for commercial navigation; bridges involving marine construction; other major bridges).

Modification Date	Publication Date
0	02/09/2007
1	07/25/2008

SUGA 1990-009 05/01/1990

	RATES	FRINGES
ASPHALT RAKER	6.55	
CARPENTER.....	8.35	
MASON (STRUCTURES)	8.07	
CONCRETE FINISHER	7.48	
FLAGGER.....	6.55	
FORM SETTER (ROAD)	7.56	
IRONWORKER (REINFORCING)	9.52	
LABORER	6.55	
PIPELAYER	6.55	
POWER EQUIPMENT OPERATORS:		
Asphalt distributor.....	6.78	
Asphalt paver.....	6.59	
Backhoe.....	8.37	
Bulldozer	8.42	
Crane	9.88	
Loader.....	7.52	
Mechanic	9.12	
Motor grader operator	8.65	
Oiler - greaser.....	6.68	
Striping machine operator	6.55	
Roller.....	6.55	
Scraper.....	8.30	
Screed - asphalt	6.55	
Sweeper	6.95	
Tractors (utility)	6.84	

**DEPARTMENT OF TRANSPORTATION
STATE OF GEORGIA**

TRUCK DRIVERS:

Single/multi rear axle6.55
Heavy duty6.75

WELDERS - Receive rate prescribed for craft performing operation to which welding is incidental.

GENERAL WAGE DECISION NO. GA080028 07/25/2008 GA28

Superseded General Wage Decision No. GA20070028

State: GEORGIA

Construction Type: Highway

County(ies): BARROW, CLARKE, JACKSON, MADISON, OCONEE

Construction description: HIGHWAY CONSTRUCTION PROJECTS (excluding tunnels, building structures in rest area projects, and railroad construction; bascule, suspension, and spandrel arch bridges; bridges designed for commercial navigation; bridges involving marine construction; other major bridges).

Modification Number	Publication Date
0	02/09/2007
1	07/25/2008

SUGA 1990-010 05/01/1990

	RATES	FRINGES
CARPENTER.....	8.95	
CONCRETE FINISHER	8.61	
FLAGGER.....	6.55	
FORM SETTER (ROAD)	7.15	
IRONWORKER (REINFORCING)	11.79	
LABORER	6.78	
MASON (STRUCTURES)	8.44	
POWER EQUIPMENT OPERATORS:		
Asphalt distributor.....	8.79	
Asphalt paver.....	8.77	
Backhoe.....	9.50	
Bulldozer	8.87	
Dragline.....	10.00	
Mechanic	11.00	
Motor grader operator (fine grade).....	9.73	
Motor grader operator	9.61	
Oiler/greaser	7.87	
Scraper.....	8.50	
Roller.....	7.89	
Rollers - finish.....	8.31	
Striping machine.....	6.55	

**DEPARTMENT OF TRANSPORTATION
STATE OF GEORGIA**

Tractor (utility).....	8.00
TRUCK DRIVERS:	
Single-rear axle.....	6.55
Multi-rear axle.....	7.90

WELDERS: Receive rate prescribed for craft performing operation to which welding is incidental.

GENERAL WAGE DECISION NO. GA080029 07/25/2008 GA29

Superseded General Wage Decision No. GA20070027

State: GEORGIA

Construction type: Highway

County(ies): COLUMBIA, MCDUFFIE, RICHMOND

Construction

Description: HIGHWAY CONSTRUCTION PROJECTS (excluding tunnels, building structures in rest area projects, and railroad construction; bascule, suspension, and spandrel arch bridges; bridges designed for commercial navigation; bridges involving marine construction; other major bridges).

Modification Number	Publication Date
0	02/09/2007
1	07/25/2008

SUGA1990-011 05/01/1990

	RATES	FRINGES
ASPHALT RAKER.....	6.55	
CARPENTER.....	8.72	
CONCRETE FINISHER.....	7.43	
FLAGGER.....	6.55	
IRONWORKER, REINFORCING.....	10.83	
LABORER.....	6.55	
PILEDRIVER.....	14.99	
POWER EQUIPMENT OPERATORS:		
Asphalt distributor.....	7.07	
Asphalt paver.....	7.64	
Backhoe.....	8.35	
Bulldozer.....	8.40	
Crane.....	10.00	
Loader.....	7.62	
Milling machine.....	12.18	
Motor grader operator.....	8.56	
Scraper.....	8.00	
Roller.....	6.55	
Striping machine operator.....	6.55	

**DEPARTMENT OF TRANSPORTATION
STATE OF GEORGIA**

Tractor (utility).....	6.55
TRUCK DRIVERS:	
Single rear Axle.....	6.55
Multi rear Axle	6.58
WELDER	11.23

GENERAL WAGE DECISION NO. GA080030 07/25/2008 GA30

Superseded General Wage Decision No. GA20070030

State: GEORGIA

Construction Type: Highway

County(ies): DOUGHERTY, LEE

Construction

Description: HIGHWAY CONSTRUCTION PROJECTS (excluding tunnels, building structures in rest area projects, and railroad construction; bascule, suspension, and spandrel arch bridges; bridges designed for commercial navigation; bridges involving marine construction; other major bridges).

Modification Number	Publication Date
0	02/09/2007
1	07/25/2008

SUGA1990-012 05/01/1990

	RATES	FRINGES
ASPHALT RAKER.....	6.55	
MASON (STRUCTURES)	6.97	
CONCRETE FINISHER	7.00	
LABORER	6.55	
POWER EQUIPMENT OPERATORS:		
Asphalt paver.....	6.55	
Loader.....	7.13	
Motor grader operator	8.39	
Roller.....	6.55	
Scraper.....	7.11	
Tractor (utility).....	6.55	
Striping machine.....	6.55	
TRUCK DRIVERS		
(Multi rear axle).....	6.55	
(Heavy duty).....	6.55	
WELDERS - Receive rate prescribed for craft performing operation to which welding is incidental.		

Unlisted classifications needed for work not included within the scope of the classifications listed may be added after award only as provided in the labor standards contract clauses (29 CFR, 5.5 (a)(1)(v)).

In the listings above, the "SU" designation means that rates listed under that identifier do not reflect collectively bargained wage and fringe benefit rates. Other designations indicate unions whose rates have been determined to be prevailing.

**DEPARTMENT OF TRANSPORTATION
STATE OF GEORGIA**

**STANDARD FEDERAL EQUAL EMPLOYMENT OPPORTUNITY CONSTRUCTION
CONTRACT SPECIFICATIONS (EXECUTIVE ORDER 11246) (43 FR 14895)**

1. As used in these specifications:
 - a. "Covered area" means the geographical area described in the solicitation from which this contract resulted;
 - b. "Director" means Director, Office of Federal Contract Compliance Programs, United States Department of Labor, or any person to whom the Director delegated authority;
 - c. "Employer Identification Number" means the Federal Social Security number used on the Employer's Quarterly Federal Tax Return, U.S. Treasury Department Form 941.
 - d. "Minority" includes:
 - (i) Black (all persons having origins in any of the Black African racial groups not of Hispanic origin);
 - (ii) Hispanic (all persons of Mexican, Puerto Rican, Cuban, Central or South American or other Spanish Culture or origin, regardless of race);
 - (iii) Asian and Pacific Islander (all persons having origins in any of the original peoples of the Far East, Southeast Asia, the Indian Subcontinent, or the Pacific Islands); and
 - (iv) American Indian or Alaskan Native (all persons having origins in any of the original peoples of North America and maintaining identifiable tribal affiliations through membership and participation or community identification).
2. Whenever the Contractor, or any Subcontractor at any tier, subcontracts a portion of the work involving any construction trade, it shall physically include in each subcontract in excess of \$10,000 the provisions of these specifications and the Notice which contains the applicable goals for minority and female participation and which is set forth in the solicitations from which this contract resulted.
3. If the Contractor is participating (pursuant to 41 CFR 60-4.5) in a Hometown Plan approved by the U.S. Department of Labor in the covered area either individually or through an association, its affirmative action obligations on all work in the Plan area (including goals and timetables) shall be in accordance with that Plan for those trades which have unions participating in the Plan. Contractors must be able to demonstrate their participation in and compliance with the provisions of any such Hometown Plan. Each Contractor or Subcontractor participating in an approved Plan is individually required to comply with its obligations under the EEO clause, and to make a good faith effort to achieve each goal under the Plan in each trade in which it has employees. The overall good faith performance by other Contractors or Subcontractors toward a goal in an approved Plan does not excuse any covered Contractor's or Subcontractor's failure to take good faith efforts to achieve the Plan goals and timetables.
4. The Contractor shall implement the specific affirmative action standards provided in paragraphs 7a through p of these specifications. The goals set forth in the solicitation from which this contract resulted are expressed as percentages of the total hours of employment and training of minority and female utilization the Contractor should reasonably be able to achieve in each construction trade in which it has employees in the covered area. The Contractor is expected to make substantially uniform progress toward its goals in each craft during the period specified.

**DEPARTMENT OF TRANSPORTATION
STATE OF GEORGIA**

5. Neither the provisions of any collective bargaining agreement, nor the failure by a union with whom the Contractor has a collective bargaining agreement, to refer either minorities or women shall excuse the Contractor's obligations under these specifications, Executive Order 11246, nor the regulations promulgated pursuant thereto.
6. In order for the non-working training hours of apprentices and trainees to be counted in meeting the goals, such apprentices and trainees must be employed by the Contractor during the training period, and the Contractor must have made a commitment to employ the apprentices and trainees at the completion of their training, subject to the availability of employment opportunities. Trainees must be trained pursuant to training programs approved by the U.S. Department of Labor.
7. The Contractor shall take specific affirmative actions to ensure equal employment opportunity. The evaluation of the Contractor's compliance with these specifications shall be based upon its effort to achieve maximum results from its actions. The Contractor shall document these efforts fully, and shall implement affirmative action steps at least as extensive as the following:
 - a. Ensure and maintain a working environment free of harassment, intimidation, and coercion at all sites, and in all facilities at which the Contractor's employees are assigned to work. The Contractor, where possible, will assign two or more women to each construction project. The Contractor shall specifically ensure that all foremen, superintendents, and other on-site supervisory personnel are aware of and carry out the Contractor's obligation to maintain such a working environment, with specific attention to minority or female individuals working at such sites or in such facilities.
 - b. Establish and maintain a current list of minority and female recruitment sources, provide written notification to minority and female recruitment sources and to community organizations when the Contractor or its unions have employment opportunities available, and maintain a record of the organization's responses.
 - c. Maintain a current file of the names, addresses and telephone numbers of each minority and female off-the-street applicant and minority or female referral from a union, a recruitment source or community organization and of what action was taken with respect to each such individual. If such individual was sent to the union hiring hall for referral and was not referred back to the Contractor by the union or, if referred, not employed by the Contractor, this shall be documented in the file with the reason therefore, along with whatever additional actions the Contractor may have taken.
 - d. Provide immediate written notification to the Director when the union or unions with which the Contractor has a collective bargaining agreement has not referred to the Contractor a minority person or woman sent by the Contractor, or when the Contractor has other information that the union referral process has impeded the Contractor's efforts to meet its obligations.
 - e. Develop on-the-job training opportunities and/or participate in training programs for the area which expressly include minority and women, including upgrading programs and apprenticeship and trainee programs relevant to the Contractor's employment needs, especially those programs funded or approved by the Department of Labor. The Contractor shall provide notice of these programs to the sources compiled under 7b above.
 - f. Disseminate the Contractor's EEO policy by providing the notice of the policy to unions and training programs and requesting their cooperation in assisting the Contractor in meeting its EEO obligations; by including it in any policy manual and collective bargaining agreement; by publicizing it in the company newspaper, annual report, etc.; by specific review of the policy with all management personnel and with all minority and female employees at least once a year, and by posting the company EEO policy on bulletin boards accessible to all employees at each location where construction work is performed.

**DEPARTMENT OF TRANSPORTATION
STATE OF GEORGIA**

- g. Review, at least annually, the company's EEO policy and affirmative action obligations under these specifications with all employees having any responsibility for hiring, assignment, layoff, termination or other employment decisions including specific review of these items with onsite supervisory personnel such as Superintendents, General Foremen, etc. prior to the initiation of construction work at any job site. A written record shall be made and maintained identifying the time and place of these meetings, persons attending, subject matter discussed, and disposition of the subject matter.
 - h. Disseminate the Contractor's EEO policy externally by including it in any advertising in the news media, specifically including minority and female news media, and providing written notification to and discussing the Contractor's EEO policy with other Contractors and Subcontractors with whom the Contractor does or anticipates doing business.
 - i. Direct its recruitment efforts, both oral and written, to minority, female and community organization, to schools with minority and female students and to minority and female recruitment and training organizations serving the Contractor's area and employment needs. Not later than one month prior to the date for the acceptance of applications for apprenticeship or other training by any recruitment source, the Contractor shall send written notification to organizations such as the above, describing the-openings, screening procedures, and test to be used in the selection process.
 - j. Encourage present minority and female employees to recruit other minority persons and women and, where reasonable, provide after school, summer and vacation employment to minority and female youth both on the site and in other areas of a Contractor's workforce.
 - k. Validate all tests and other selection requirements where there is an obligation to do so under 41 CFR Part 60-3.
 - l. Conduct, at least annually, an inventory and evaluation of all minority and female personnel for promotional opportunities and encourage these employees to seek or to prepare for, through appropriate training, etc. such opportunities.
 - m. Ensure that seniority practices, job classifications, work assignments and other personnel practices, do not have a discriminatory effect by continually monitoring all personnel and employment related activities to ensue that the EEO policy and the Contractor's obligations under these specifications are being carried out.
 - n. Ensure that all facilities and company activities are non-segregated except that separate or single-user toilet and necessary changing facilities shall be provided to assure privacy between the sexes.
 - o. Document and maintain a record of all solicitations of offers for subcontracts from minority and female construction contractors and suppliers, including circulation of solicitations to minority and female contractor associations and other business associations.
 - p. Conduct a review, at least annually of all supervisors' adherence to and performance under the Contractor's EEO policies and affirmative action obligations.
8. Contractors are encouraged to participate in voluntary associations which assist in fulfilling one or more of their affirmative action obligations (7a through p). The efforts of a contractor association, joint contractor-union, contractor-community, or other similar group of which the contractor is a member and participant, may be asserted as fulfilling any one or more of its obligations under 7a through p of these Specifications provided that the contractor actively participates in the group, makes every effort to assure that the group has a positive impact on the employment of minorities and women in the industry, ensures that the concrete

**DEPARTMENT OF TRANSPORTATION
STATE OF GEORGIA**

benefits of the program are reflected in the Contractor's minority and female workforce participation, makes a good faith effort to meet its individual goals and timetables, and can provide access to documentation which demonstrates the effectiveness of actions taken on behalf of the Contractor. The obligation to comply, however, is the Contractor's and failure of such a group to fulfill an obligation shall not be a defense for the Contractor's noncompliance.

9. A single goal for minorities and a separate single goal for women have been established. The Contractor, however, is required to provide equal employment opportunity and to take affirmative action for all minority groups, both male and female, and all women, both minority and non-minority. Consequently, the Contractor may be in violation of the Executive Order if a particular group is employed in a substantially disparate manner (for example, even though the Contractor has achieved its goals for women generally, the Contractor may be in violation of the Executive Order if a specific minority group of women is underutilized).
10. The Contractor shall not use the goals and timetables or affirmative action standards to discriminate against any person because of race, color, religion, sex, or national origin.
11. The Contractor shall not enter into any subcontract with any person or firm debarred from Government contracts pursuant to Executive Order 11246.
12. The Contractor shall carry out such sanctions and penalties for violation of these specifications and of the Equal Opportunity Clause, including suspension, termination and cancellation of existing subcontracts as may be imposed or ordered pursuant to Executive Order 11246, as amended, and its implementing regulations, by the Office of Federal Contract Programs. Any contractor who fails to carry out such sanctions and penalties shall be in violation of these specifications and Executive Order 11246, as amended.
13. The Contractor, in fulfilling its obligations under these specifications, shall implement specific affirmative action steps, at least as extensive as those standards prescribed in paragraph 7 of these specifications, so as to achieve maximum results from its efforts to ensure equal employment opportunity. If the Contractor fails to comply with the requirements of the Executive Order, the implementing regulations, or these specifications, the Director shall proceed in accordance with 41 CFR 60-4.8.
14. The Contractor shall designate a responsible official to monitor all employment related activity to ensure that the company EEO policy is being carried out, to submit reports relating to the provisions hereof as may be required by the Government and to keep records. Records shall at least include for each employee the name, address, telephone numbers, construction trade, union affiliation if any, employee identification number when assigned, social security number, race, sex, status (e.g., mechanic, apprentice, trainee, helper, or laborer), dates of changes in status, hours worked per week in the indicated trade, rate of pay, and locations at which the work was performed. Records shall be maintained in an easily understandable and retrievable form; however, to the degree that existing records satisfy this requirement, contractors shall not be required to maintain separate records.
15. Nothing herein provided shall be construed as a limitation upon the application of other laws which establish different standards of compliance or upon the application of requirements for the hiring of local or other area residents (e.g., those under the Public Works Employment Act of 1977 and the Community Development Block Grant Program).

NOTICE OF REQUIREMENT FOR AFFIRMATIVE ACTION TO ENSURE EQUAL EMPLOYMENT OPPORTUNITY (EXECUTIVE ORDER 11246) (43 FR 14895)

1. The Offeror's or Bidder's attention is called to the "Equal Opportunity Clause" and the "Standard Federal Equal Employment Opportunity Construction Contract Specifications" set forth herein.
2. The goals and timetables for minority and female participation, expressed in percentage terms for the Contractor's aggregate workforce in each trade on all construction work in the covered areas, are as follows:

GOALS FOR FEMALE PARTICIPATION

APPENDIX A
(43 FR 19473)

The following goals and timetables for female utilization shall be included in all Federal and federally assisted construction contracts and subcontracts in excess of \$10,000. The goals are applicable to the contractor's aggregate on-site construction workforce whether or not part of that workforce is performing work on a Federal or federally-assisted construction contract or subcontract. Area covered: Goals for Women apply nationwide.

Goals and timetables

Timetable	Goals percent)
4-1-78 to 3-31-79	3.1
4-1-79 to 3-31-80	5.0
4-1-80 Until Further Notice	6.9

GOALS FOR
MINORITY PARTICIPATION

Appendix B-80

Until further notice, the following goals for minority utilization in each construction craft and trade shall be included in all Federal or federally assisted construction contracts and subcontracts in excess of \$10,000 to be performed in the respective geographical areas. The goals are applicable to each nonexempt contractor's total onsite construction workforce, regardless of whether or not part of that workforce is performing work on a Federal, federally assisted or non-federally related project, contract or subcontract.

FEDERAL REGISTER / VOL. 45. NO. 194 / FRIDAY, OCTOBER 3,1980 /NOTICES

Construction contractors which are participating in an approved Hometown Plan (see 41 CFR 60-4-5) are required to comply with the goals of the Hometown Plan with regard to construction work they perform in the areas covered by the Hometown Plan. With regard to all their other covered construction work, such contractors are required to comply with the applicable SMSA or EA goal contained in this appendix B-80.

FEDERAL REGISTER / VOL. 45, NO. 194 / FRIDAY. OCTOBER 3,1980 / NOTICES

State	Goal (percent)
Georgia:	
035 Augusta, GA:	
SMSA Counties:	
0600 Augusta, GA-SC.....	27.2
GA Columbia; GA Richmond; SC Aiken;	
Non-SMSA Counties.....	32.-8
GA Burke; GA Emanuel; GA Glascock; GA Jefferson;	
GA Jenkins; GA Lincoln; GA McDuffie; GA Talferferro;	
GA Warren; GA Wilkes; SC Allendale; SC Bamberg;	
SC Barnwell; SC Edgefield; SC McCormick;	
036 Atlanta, GA:	
SMSA Counties:	
0520 Atlanta, GA	21.2
GA Butts; GA Cherokee; GA Clayton; GA	
Cobb; GA DeKalb; GA Douglas; GA Fayette; GA	
Forsyth; GA Fulton; GA Gwinnett; GA Henry; GA	
Newton; GA Paulding; GA Rockdale; GA Walton	
Non-SMSA Counties.....	19.5
GA Banks; GA Barrow; GA Carroll; GA Clarke;	
GA Coweta; GA Dawson; GA Elbert; GA Fannin;	
GA Floyd; GA Franklin; GA Gilmer; GA Gordon;	
GA Greene; GA Habersham; GA Hall; GA	
Haralson; GA Hart; GA Heard; GA Jackson; GA	
Jasper; GA Lamar; GA Lumpkin; GA Madison;	
GA Morgan; GA Oconee; GA Oglethorpe; GA	
Pickins; GA Pike; GA Polk; GA Rabun; GA	
Spalding; GA Stephens; GA Towns; GA Upson; GA	
White	
037 Columbus, GA:	
SMSA Counties:	
1800 Columbus, GA-AL.....	29.6
Al Russell; GA Chattahoochee; GA Columbus	

Non-SMSA Counties.....	36.1
Al Chambers; AJ Lee: GA Harris; GA Marion: GA Meriwether; GA Quitman; GA Schley; GA Stewart; GA Sumter; GA Talbot; GA Troup; GA Webster	
038 MACON. GA	
SMSA Counties:	
4680 Macon, GA.....	27.5
GA Bibb; GA Houston: GA Jones; GA Twiggs	
Non-SMSA Counties	31.7
GA Baldwin; GA Bleckley: Crawford; GA Crisp; GA Dodge; GA Dooly; GA Hancock: GA Johnson; GA Laurens: GA Macon; GA Monroe; GA Peach; GA Pulaski; GA Putnam; GA Taylor; GA Telfair; GA Treutlan; GA Washington; GA Wheeler; GA Wilcox; GA Wilkinson	
039 Savannah, GA:	
SMSA Counties:	
7520 Savannah, GA	30.6
GA Bryan; GA Chatham; GA Effingham	
Non-SMSA, Counties.....	29.8
GA Appling; GA Atkinson; GA Bacon; GA Bulloch; GA Candler; GA Coffee; GA Evans; GA Jeff Davis; GA Liberty; GA Long; GA McIntosh; GA Montgomery; GA Screven; GA Tattall; GA Toombs; GA Wayne; SC Beaufort; SC Hampton; SC Jasper	
040 Albany, GA:	
SMSA Counties:	
0120 Albany, GA.....	32.1
GA Dougherty; GA Lee	
Non-SMSA Counties	31.1
GA Baker; GA Ben Hill; GA Berrien; GA Brooks; GA Calhoun; GA Clay; GA Clinch; GA Colquitt; GA Cook; GA Decatur; GA Early; GA Echols; GA Grady; GA Irwin; GA Lanier; GA Lowndes; GA Miller; GA Mitchell; GA Randolph; GA Seminole; GA Terrell; GA Thomas; GA Tift; GA Turner; GA Worth	

DEPARTMENT OF TRANSPORTATION
STATE OF GEORGIA
DISADVANTAGED BUSINESS ENTERPRISE PROGRAM
CRITERIA FOR ACCEPTABILITY

The purpose of this special provision is to establish criteria for acceptability of DBE firms for work performed on this contract. The intent is to ensure all participation counted toward fulfillment of the DBE goals is (1) real and substantial, (2) actually performed by viable, independent DBE owned firms, and (3) in accordance with the spirit of the applicable laws and regulations.

The policy of the Georgia Department of Transportation is to ensure compliance with Title VI of the Civil Rights Act of 1964, 49 Code of Federal Register, Part 26 and related statutes and regulations in all program activities.

To this end the Georgia Department of Transportation shall not discriminate on the basis of race, color, sex or national origin in the award, administration and performance of any Georgia Department of Transportation assisted contract or in the administration of its Disadvantaged Business Enterprise Program. The Georgia Department of Transportation shall take all necessary and reasonable steps to ensure nondiscrimination.

DBE payments and commitments for Federal-aid projects shall be separate and distinct and cannot be transferred or combined in any matter.

The DBE Goal specified in the contract will be a percentage representing the DBE Race Conscious Participation. The Contractor will strive to achieve an additional percentage, cumulatively amounting but not limited to 4 percent in his/her contracts for all projects during the course of the current State Fiscal Year, in order to meet the overall Georgia Department of Transportation DBE goal.

DBE PROCEDURES: The Contractor shall develop techniques to facilitate DBE participation in subcontracting activities. These techniques include:

- (A) Arranging solicitations, time for the presentation of quotes, quantities, specifications, and delivery schedules to facilitate the participation of DBEs.
- (B) Providing assistance to DBEs in overcoming barriers such as the inability obtaining bonding, financing, or technical assistance.

DBE DIRECTORY: The Department has available a directory or source list to facilitate identifying DBEs with capabilities relevant to general contracting requirements and to particular solicitations. The Department will make the directory available to bidders and proposers in their efforts to meet the DBE requirements. The directory or listing includes firms which the Department has certified to be eligible DBEs in accordance with 49 CFR Part 26.

GOAL FOR PARTICIPATION: If a percentage goal for DBE participation in this contract is set forth elsewhere in this proposal, the Contractor shall complete the DBE GOALS Form included in the proposal. The Contractor is encouraged to make every effort to achieve the goal set by the Department. However, if the Contractor cannot find sufficient DBE participants to meet the goal established by the Department, the Department will consider for award a proposal with less participation than the established goal if:

- (A) The bidder can demonstrate no greater participation could be obtained. This should be well documented by demonstrating the Contractor's actions through good faith efforts.

The following is a list of types of actions which the Department will consider as part of the Contractor's good faith efforts to obtain DBE participation. This is not intended to be a mandatory checklist nor intended to be exclusive or exhaustive. Other factors or types of efforts may be relevant in appropriate cases.

- (1) Soliciting through all reasonable and available means (e.g. attendance at pre-bid meetings, advertising and/or written notices) the interest of all certified DBEs who have the capability to perform the work of the contract. The Contractor must solicit this interest within sufficient time to allow the DBEs to respond to the

solicitation. The Contractor must determine with certainty if the DBEs are interested by taking appropriate steps to follow up initial solicitations.

- (2) Selecting portions of the work to be performed by DBEs in order to increase the likelihood the DBE goals will be achieved. This includes, where appropriate, breaking out contract work items into economically feasible units to facilitate DBE participation, even when the Contractor might otherwise prefer to perform these work items with its own forces.
- (3) Providing interested DBEs with adequate information about the plans, specifications, and requirements of the contract in a timely manner to assist DBE participants in responding to a solicitation.
- (4) (a) Negotiating in good faith with interested DBEs. Contractor(s) are responsible to make a portion of the work available to DBE subcontractors and suppliers and to select those portions of the work or material needs consistent with the available DBE subcontractors and suppliers, so as to facilitate DBE participation. Evidence of such negotiation includes the names, addresses, and telephone numbers of DBEs that were considered; a description of the information provided regarding the plans and specifications for the work selected for subcontracting; and evidence as to why additional agreements could not be reached for DBEs to perform the work.
(b) Contractor(s) using good business judgment would consider a number of factors in negotiating with subcontractors, including DBE subcontractors, and would take a firm's price and capabilities as well as contract goals into consideration. However, the fact there may be some additional costs involved in finding and using DBEs is not in itself sufficient reason for a bidder's failure to meet the contract DBE goal, as long as such costs are reasonable. Also,

the ability or desire of a Contractor to perform the work of a contract with its own organization does not relieve the Contractor of the responsibility to make good faith efforts. Contractors are not, however, required to accept higher quotes from DBEs if the price difference is excessive or unreasonable.

- (5) Not rejecting DBEs as being unqualified without sound reasons based on a thorough investigation of their capabilities. The Contractor's standing within its industry, membership in specific groups, organizations, or associations and political or social affiliations (for example union vs. nonunion employee status) are not legitimate causes for the rejection or non solicitation of bids in the Contractor's efforts to meet the project goal.
 - (6) Making efforts to assist interested DBEs in obtaining bonding, lines of credit, or insurance as required by the contractor.
 - (7) Making efforts to assist interested DBEs in obtaining necessary equipment, supplies, materials, or related assistance or services.
 - (8) Effectively using the services of available minority/women community organizations; minority/women Contractors' groups; local, state, and Federal minority/women business assistance offices; and other organizations as allowed on a case-by-case basis to provide assistance in the recruitment and placement of DBE's.
- (B) The participation proposed by the low bidder is not substantially less than the participation proposed by the other bidders on the same contract.

If no percentage goal is set forth in the proposal, the contractor may enter a proposed DBE participation. This voluntary DBE participation will count as race neutral DBE participation. Prime Contractor shall report race-neutral participation in accordance with the DBE Quarterly Report requirements shown in this document.

To be eligible for award of this contract,

All bidders will be required to submit the following information to the Department by the close of business on the 3rd working day following opening of the bid as a matter of bidder responsibility.

- (1) The names and addresses of DBE firms committed to participate in the Contract;
- (2) A description of the work each DBE will perform;
- (3) The dollar amount of the participation of each DBE firm participating;
- (4) Written documentation of the bidder's commitment to use a DBE subcontractor whose participation it submits to meet a contract goal;
- (5) Written confirmation from the DBE committed to participating in the contract, as provided in the prime contractor's commitment.
- (6) If the contract goal is not met, evidence of good faith efforts must be provided.

Failure by a bidder to furnish the above information may subject the bid to disqualification. Also failure by the bidder to submit satisfactory evidence of good faith efforts may subject the bid to disqualification.

Award of a contract by the Department to a Prime Contractor who has listed DBE participants with the bid may not constitute final approval by the Department of the listed DBE. The Department reserves the right to approve or disapprove a Disadvantaged firm after a review of the Disadvantaged firm's proposal participation. Payment to the Contractor under the contract may be withheld until final approval of the listed DBEs is granted by the Department.

If the Contractor desires to substitute a DBE in lieu of those listed in the proposal, a letter of concurrence shall be required from the listed DBE prior to approval of the substitution, unless this requirement is waived by the Department.

Agreements between bidder and a DBE in which promises not to provide Subcontracting quotations to other bidders are prohibited.

DEFINITION: For the purposes of this provision, the following definitions will apply:

Disadvantaged Business Enterprise or DBE means a for-profit small business concern –

- (1) Ensuring at least 51 percent owned by one or more individuals who are both socially and economically disadvantaged or, in the case of a corporation, in which 51 percent of the stock is owned by one or more such individuals; and

- (2) Whose management and daily business operations are controlled by one or more of the socially and economically disadvantaged individuals who own the business.

Good Faith Efforts means efforts to achieve a DBE goal or other requirement of this part which, by their scope, intensity, and appropriateness to the objective, can reasonably be expected to fulfill the program requirement.

Joint Venture means an association of a DBE firm and one or more other firms to carry out a single, for-profit business enterprise, for which the parties combine their property, capital, efforts, skills and knowledge, and in which the DBE is responsible for a distinct, clearly defined portion of the work of the contract and whose share in the capital contribution, control, management, risks, and profits of the joint venture are commensurate with its ownership interest.

Socially and Economically Disadvantaged Individual means any individual who is a citizen (or lawfully admitted permanent resident) of the United States and who is –

- (1) Any individual who the Department finds to be a socially and economically disadvantaged individual on a case-by-case basis.
- (2) Any individual in the following groups, members of which are reputedly presumed to be socially and economically disadvantaged.
 - (i) “Black Americans,” which includes persons having origins, in any of the Black racial groups of Africa;
 - (ii) “Hispanic Americans,” which includes persons of Mexican, Puerto Rican, Cuban, Dominican, Central or South American, or other Spanish or Portuguese culture or origin, regardless of race;
 - (iii) “Native Americans,” which includes persons who are American Indians, Eskimos, Aleuts, or Native Hawaiians;
 - (iv) “Asian-Pacific Americans,” which includes persons whose origins are from Japan, China, Taiwan, Korea, Burma (Myanmar), Vietnam, Laos, Cambodia (Kampuchea), Thailand, Malaysia, Indonesia, the Philippines, Brunei, Samoa, Guam, the U.S. Trust Territories of the Pacific Islands (Republic of Palau), the

- Commonwealth of the Northern Marianas Islands, Macao, Fiji, Tonga, Kiribati, Juvalu, Nauru, Federated States of Micronesia, or Hong Kong;
- (v) “Subcontinent Asian Americans,” which includes persons whose origins are from India, Pakistan, Bangladesh, Bhutan, the Maldives Islands, Nepal or Sri Lanka;
 - (vi) Women;
 - (vii) Any additional groups whose members are designated as socially and economically disadvantaged by the SBA, at such time as the SBA designation becomes effective.

(3) GDOT will presume that such persons are socially and economically disadvantaged only to the extent permitted by applicable federal law.

Race-conscious measure is one focused specifically on assisting only DBEs, including women-owned DBEs.

Race-neutral measure is one being, or can be, used to assist all small businesses. For the purposes of this part, race-neutral includes gender-neutrality.

DISCRIMINATION PROHIBITED: No person shall be excluded from participation in, denied the benefits of, or otherwise discriminated against in connection with the award and performance of this contract on the grounds of race, color, sex or national origin.

The following assurance becomes a part of this contract and must be included in and made a part of each subcontract the prime contractor enters into with their subcontractors (49 CFR 26.13):

“The contractor, and/or subcontractor shall not discriminate on the basis of race, color, national origin, or sex in the performance of this contract. The contractor shall carry out applicable requirements of 49 CFR Part 26 in the award and administration of DOT – assisted contracts. Failure by the contractor to carry out these requirements is (breach) of this contract which may result in the termination of this contract or such other remedy as the Department deems appropriate.

Failure to Achieve Requirements: Periodic reviews shall be made by the Department to determine the extent of compliance with the requirements set forth in this provision. If the Contractor is found to be in noncompliance, further payments for any work performed may be withheld until corrective action is taken. If corrective action is not taken, it may result in termination of this contract.

Participation will be counted toward fulfillment of the DBE goal as follows:

- (A) When a DBE participates in a contract, the Contractor counts only the value of the work actually performed by the DBE toward DBE goals.
 - (1) Count the entire amount of the portion of a construction contract (or other contract not covered by paragraph (A) (2) of this section) performed by the DBE's own forces. Include the cost of supplies and materials obtained by the DBE for the work of the contract, including supplies purchased or equipment leased by the DBE (except supplies and equipment the DBE subcontractor purchases or leases from the prime contractor or its affiliate).
 - (2) Count the entire amount of fees or commissions charged by a DBE firm for providing a bona fide service, such as professional, technical consultant, or managerial services, or for providing bonds or insurance specifically required for the performance of a DOT-assisted contract, toward DBE goals, provided the Department determines the fee is reasonable and not excessive as compared with fees customarily allowed for similar services.
 - (3) When a DBE subcontracts part of the work of its contract to another firm, the value of the subcontracted work may be counted toward DBE goals only if the DBE's subcontractor is itself a DBE. Work that a DBE subcontracts to a non-DBE firm does not count toward DBE goals.
- (B) When a DBE performs as a participant in a joint venture, count a portion of the total dollar value of the contract equal to the distinct, clearly defined portion of

the work of the contract the DBE performs with own forces toward DBE goals.

- (C) Count expenditures to a DBE contractor toward DBE goals only if the DBE is performing a commercially useful function on that contract.
- (1) A DBE performs a commercially useful function when responsible for execution of the work of the contract and carrying out responsibilities by actually performing, managing, and supervising the work involved. To perform a commercially useful function, the DBE must also be responsible, with respect to materials and supplies used on the contract, for negotiating price, determining quality and quantity, ordering the material, and installing (where applicable) and paying for the material itself.
 - (2) A DBE does not perform a commercially useful function if their role is limited to being an extra participant in a transaction, contract, or project through which funds are passed in order to obtain the appearance of DBE participation.
 - (3) If a DBE does not perform or exercise responsibility for at least 30 percent of the total cost of their contract with their own work force, or the DBE subcontracts a greater portion of the work of a contract than would be expected on the basis of normal industry practice for the type of work involved, the Department will presume the DBE is not performing a commercially useful function.
 - (4) When a DBE is presumed not to be performing a commercially useful function as provided in paragraph (C) (3) of this section, the DBE may present evidence to rebut this presumption.
 - (5) The Department's decisions on commercially useful function matters are subject to review by the US DOT, but are administratively appealable to the US DOT.
- (D) The following factors are to be used in determining whether a DBE trucking company is performing a commercially useful function:
- (1) The DBE must be responsible for the management and

supervision of the entire trucking operation for which they are responsible on a particular contract, and there cannot be a contrived arrangement for the purpose of meeting DBE goals.

- (2) The DBE must itself own and operate at least one fully licensed, insured, and operational truck used on the contract.
 - (3) The DBE receives credit for the total value of the transportation services it provides on the contract using trucks it owns, insures, and operates using drivers it employs.
 - (4) The DBE may lease trucks from another DBE firm, including an owner/operator who is certified as a DBE. The DBE who leases trucks from another DBE receives credit for the total value of the transportation services the lessee DBE provided on the contract.
 - (5) The DBE may also lease trucks from a non-DBE and is entitled to credit only for the fee or commission it receives as a result of the lease arrangement. The DBE does not receive credit for the total value of the transportation services provided by the lessee, since these services are not provided by a DBE.
 - (6) For purposes of this paragraph (D), a lease must indicate the DBE has exclusive use of and control over the truck. This does not preclude the leased truck from working for others during the term of the lease with the consent of the DBE, so long as the lease gives the DBE absolute priority for use of the leased truck. Leased trucks must display the name and identification number of the DBE.
- (E) Count expenditures with DBEs for materials or supplies toward DBE goals as provided in the following:
- (1) (i) If the materials or supplies are obtained from a DBE manufacturer, count 100 percent of the cost of the materials or supplies toward DBE goals.
(ii) For purposes of this paragraph, a manufacturer is a firm that operates or maintains a factory or establishment that produces, on the premises, the materials, supplies, articles, or equipment required under the contract and of the general character

described by the specifications.

(2) (i) If the materials or supplies are obtained from a DBE regular dealer, count 60 percent of the cost of the materials or supplies toward DBE goals.

(ii) For purposes of this section, a regular dealer is a firm owning, operating, or maintaining a store, warehouse, or other establishment in which the materials, supplies, articles or equipment of the general character described by the specifications and required under the contract are bought, kept in stock, and regularly sold or leased to the public in the usual course of business.

(A) To be a regular dealer, the firm must be an established, regular business engaging, as its principal business and under its own name, in the purchase and sale or lease of the products in question.

(B) A person may be a regular dealer in such bulk items as petroleum products, steel, cement, gravel, stone, or asphalt without owning, operating, or maintaining a place of business as provided in this paragraph **(E)(2)(ii)** if the person both owns and operates distribution equipment for the products. Any supplementing of regular dealers' own distribution equipment shall be by a long-term lease agreement and not on an ad hoc or contract-by-contract basis.

(C) Packagers, brokers, manufacturers' representatives, or other persons who arrange or expedite transactions are not regular dealers within the meaning of this paragraph **(E)(2)**.

(3) With respect to materials or supplies purchased from a DBE which is neither a manufacturer nor a regular dealer, count the entire amount of fees or commissions charged for assistance in the procurement of the materials and supplies, or fees or transportation charges for the delivery of materials or supplies required on a job site, toward DBE goals, provided you determine the fees to be reasonable and not excessive as compared with fees customarily allowed for similar services. Do not count any portion of the cost of the materials and supplies themselves toward DBE goals, however.

- (4) Do not count the participation of a DBE subcontractor toward the prime contractor's DBE achievements until the amount being counted toward the goal has been paid to the DBE.
- (5) No participation will be counted not in compliance with Special Provision entitled "Criteria for Acceptability" which is a part of this contract or with any provisions included in 49 CFR Part 26.
- (6) If the contract amount overruns, the contractor will not be required to increase the dollar amount of DBE participation. If the contract amount under runs, the contractor will not be allowed to under run the dollar amount of DBE participation except when the DBE subcontracted items themselves under run.

REPORTS

A: The contractor shall submit a "DBE Participation Report" on this contract quarterly which shall include the following:

1. The name of each DBE participating in the contract.
2. A description of the work to be performed, materials, supplies, and services provided by each DBE.
3. Whether each DBE is a supplier, subcontractor, owner/operator, or other.
4. The dollar value of each DBE subcontract or supply agreement.
5. The actual payment to date of each DBE participating in the contract.
6. The report shall be updated by the Prime Contractor whenever the approved DBE has performed a portion of the work that has been designated for the contract. Copies of this report should be transmitted promptly to the Engineer. Failure to submit the report with 30 calendar days following the end of the quarter may cause payment to the contractor to be withheld.
7. The Prime Contractor shall notify the Project Engineer at least 24 hours prior to the time the DBE commences working on the project. The DBE must furnish supervision of the DBE portion of the work, and the person responsible for this supervision must report to the Project Engineer when they begin work on the project. They must also inform the project engineer when their forces will be doing work on the project.

B. In order to comply with 49 CFR 26.11, the Prime Contractor shall submit documentation regarding all payments made from the Prime to all DBE subcontractors on federal aid projects in the form of copies of cancelled checks or notarized electronic documentation which validates said payments made on the DBE Quarterly Participation Reports. This information shall be required quarterly and submitted with the DBE Quarterly Participation Report.

C. Failure to respond within the time allowed in the request will be grounds for withholding all payments on all Contracts.

SUBSTITUTION OF DBEs: The Contractor shall make reasonable efforts to replace a DBE Subcontractor unable to perform work for any reason with another DBE. The Department shall approve all substitutions of Subcontractors in order to ensure the substitute firms are eligible DBEs.

CERTIFICATION OF DBEs: To ensure the DBE Program benefits only firms owned and controlled by Disadvantaged Individuals, the Department shall certify the eligibility of DBEs and joint ventures involving DBEs named by bidders.

Questions concerning DBE Certification should be directed to the EEO Office at (404) 631-1972.

**DEPARTMENT OF TRANSPORTATION
STATE OF GEORGIA**

First Use 2001 Specifications: November 01, 2002
Revised: November 19, 2006

SPECIAL PROVISION

PROMPT PAYMENT:

Prime Contractors, who sublet a portion of their work, shall pay their subcontractors for satisfactory performance of their contracts no later than 10 calendar days from receipt of each payment made to them.

Any delay or postponement of payment among the parties may take place only for good cause with prior written approval from the Department.

If the contractor is found to be in noncompliance with these provisions, it shall constitute a breach of contract and further payments for any work performed may be withheld until corrective action is taken. If corrective action is not taken, it may result in termination of the contract.

All subcontract agreements shall contain this requirement.

**DEPARTMENT OF TRANSPORTATION
STATE OF GEORGIA**

REQUIRED CONTRACT PROVISIONS FOR FEDERAL-AID CONTRACTS

BUY AMERICA

Revised: March 25, 1992

Revised: January 7, 1994

Revised: June 9, 1995

First Use 2001 Specifications: November 1, 2002

All manufacturing processes for steel and iron materials and steel and iron coatings permanently incorporated into this project must occur in the United States of America. However, pig iron and processed, pelletized, or reduced iron ore used in the production of these products may be manufactured outside the United States.

This requirement, however, does not prevent a minimal use of foreign materials and coatings, provided the cost of materials and coatings used does not exceed one-tenth of one percent (0.1 percent) of the total contract cost or \$2,500.00, whichever is greater.

NOTE: Coatings include: epoxy coating, galvanizing, painting and any other coating that protects or enhances the value of the material.

CONVICT PRODUCED MATERIALS

March 25, 1992

Revised: September 6, 1993

First Use 2001 Specifications: November 1, 2002

Materials produced by convict labor after July 1, 1991, may not be used for Federal-Aid highway construction projects unless it meets the following criteria:

1. The materials must be produced by convicts who are on parole, supervised release or probation from a prison; or,
2. If produced in a qualified prison facility, the amount of such materials produced in any 12-month period shall not exceed the amount produced in such facility for such construction during the 12-month period ending July 1, 1987. A qualified prison is defined as one producing convict made materials prior to July 1, 1987.

**DEPARTMENT OF TRANSPORTATION
STATE OF GEORGIA**

SPECIAL PROVISION

Project Number: CSNHS-0008-00(415)

P.I. Number: 0008415

Fulton County

Utility Conflicts

Utility companies having known facilities that conflict with the construction of this project will be directed by the Department to adjust or relocate their facilities and will be notified of the contract award.

Conform to all the requirements of the Specifications as they relate to cooperation with utility owners and the protection of utility installations that exist on the project. Refer to the requirements of Section 107, Legal Regulations and Responsibility to the Public, with particular attention to Subsection 107.21.

Coordinate The Work with any work to be performed by others in any right of way clearance and arrange a schedule of operations that will allow for completion of the Project within the specified contract time. Where stage construction is required, notify the utility owner when each stage of work is completed and the site is available for utility work to proceed.

Information concerning utility facilities known to exist within the project limits, including the list of owners, is shown on the plans.

Under Georgia Code Section 32-6-171, utilities are required to remove or relocate their facilities. The Department is required to give the utility at least 60 days written notice directing the removal and relocation, and the utility is required to begin removal within a reasonable time thereafter.

Utility Owners that are under agreement with the Department, as listed on the Office of Utilities website at <http://www.dot.state.ga.us/dot/operations/utilities/index.shtml>, are liable to the Contractor for his cost for delays to construction that are due to the utilities' failure to clear conflicts within the time submitted by the Utility Owner in the Utility Adjustment Schedule as approved by the Department. Any modifications to the approved Utility Adjustment Schedule shall require review and approval by the Department, the Utility Owner, and the Contractor. Utility facilities originally permitted within State Rights of Way are similarly liable to the Department and Contractor for extraordinary costs or damages. The Contractor may bill the utility company directly for any costs or delays as described in the agreement between the Department and the utility

company. Such bill shall be submitted in accordance with O.C.G.A. 32-6-171 and procedures established therein and shall be sufficiently detailed to allow the utility company to verify that the charges are accurate and properly attributable to delays in relocation of their facilities. Upon request, copies of all agreements with utility companies having facilities on this project will be made available for examination by the Contractor at the Department's District Office. Utility Adjustment Schedules, when submitted to the Department by the utilities, will be made available to the Contractor upon request at the Department's District Office unless furnished by Contracts Administration at the Plans Sales window or may be included with the Utility Special Provision in the Contract Proposal on select projects.

In accordance with Subsection 105.06 of the Specifications, the Department is not liable for payment of any claims due to utility delays, inconvenience or damage sustained by the Contractor due to interference of any utilities or appurtenances, or the operation of moving them. In accordance with Subsection 107.21.G delays by utilities will continue to be considered by the Department in charging Contract Time. For purposes of applying provisions of this paragraph, railroads and the Metropolitan Atlanta Rapid Transit Authority (MARTA) are considered utilities.

First Use Date: January 14, 2005
Revised February 4, 2008

**DEPARTMENT OF TRANSPORTATION
STATE OF GEORGIA**

SPECIAL PROVISION

Project Number: CSNHS-0008-00(415)

P.I. Number: 0008415

Fulton County

SECTION 102-Bidding Requirements and Conditions

The use of the Electronic Bid Bond Form in Expedite will be accepted by the Department for compliance with the Notice To Contractors requirement to utilize the "Bid Bond Form DOT 564-Rev. Dec. 13, 2004".

First use date: November 1, 2004
Revised 10/27/04
Revised 12/02/07
Revised 09/05/08

Georgia Department of Transportation

State of Georgia

Project Number: CSNHS-0008-00(415)

P.I. Number: 0008415

Fulton County

Special Provision

Section 102—Bidding Requirements and Conditions

Delete Subsection 102.01 and Substitute the following:

102.01 Prequalification of Bidders

Before submitting a bid in excess of \$2,000,000, the Bidder shall have been prequalified with the Department and received a Certificate of Qualification in accordance with the Rules and Regulations approved and adopted by the State Transportation Board. Bidders submitting bids of \$2,000,000 or less may be exempt from prequalification requirements. In addition, the aggregate total amount a Non-prequalified Bidder may have under contract shall not exceed \$4,000,000. Bidders intending to consistently submit Proposals shall prequalify at least once a year. However, qualifications may be changed during that period upon the submission of additional favorable reports or upon unsatisfactory performance. In addition, the Department reserves the right at any time to require the Contractor to furnish a current financial and experience statement.

Delete Subsection 102.03 and Substitute the following:

102.03 Contents of Proposal Forms

Upon request, the Department will furnish the prospective Bidder with a Valid for Bidding Proposal Form. Only one Valid for Bidding Proposal will be issued to a prospective Bidder for each proposal being considered to be bid. This form will state the location and description of the contemplated construction and will show the approximate estimate of the various quantities and kinds of work to be performed or materials to be furnished, and will have a schedule of Items for which Unit Bid prices are invited. The Proposal Form will state the time in which The Work must be completed, the amount of the Proposal Guaranty, and the date of the opening of Proposals. The Form will also include any Special Provisions or requirements that vary from or are not contained in the *Specifications*. Also included with each Proposal Form will be a Non-Collusion Certificate. All papers bound with or attached to the Proposal Form are considered a part thereof and must not be detached or altered when the Proposal is submitted. The Plans, Specifications, and other documents designated in the Proposal Form will be considered a part of the Proposal whether attached or not. The prospective Bidder will be required to pay the Department the sum stated in the Notice to Contractors for each Valid for Bidding Proposal Form and each set of Plans.

Delete Subsection 102.06 and Substitute the following:

102.06 Preparation of Proposal

The Bidder shall submit its Proposal on the form furnished by the Department (GADOT). The blank spaces on the Proposal shall be filled in correctly for each Pay Item (except alternate items) and the Bidder shall write in ink the Unit Price or a Lump Sum Price as called for in the Proposal for each Pay Item listed therein. In addition, the Bidder shall also show the products of the respective Unit Prices and quantities and the total amount of the Bid by adding the amounts of all Bid Items. In the event of a discrepancy in any of the figures, the Unit Price will govern and the Bid will be recalculated.

In addition, the Bidder shall submit a technical proposal which shall include, but is not limited to, the design build firm's detailed project schedule (including those submittals and estimated review periods shown in Table A-1 of the attached Special Provision 999, and in other areas of Special Provision 999 where due dates are mentioned), permit requirements, expected plans approval, total contract time, mobilization assumptions, a detailed Maintenance of Traffic (MOT) plan, construction staging assumptions, public involvement plan, as well as a detailed estimate with all material quantities and price assumptions used to form the basis of the bid. The Bidder shall also clearly document all assumptions in this technical proposal. There are no page limit restrictions for the technical proposal.

These items listed above are the minimum requirements of what shall be included in the technical proposal. The intent of the technical proposal is to provide some insight into the Contractor's approach both with schedule and with the assumed quantities and costs used to formulate the bid. As noted in section 999.1.A.2 "Bids on this project shall reflect designing and constructing the project as shown in the Scope (999.1.A.3) and applicable portions of the Plans Package. No exceptions shall be assumed by the Contractor. However, alternative proposals on portions of the work will be entertained once the project is awarded." Therefore, no deviations shall be included in the bid or technical proposal.

In the case of Alternate items, Unit Prices shall be entered for only one alternate.

The Non-Collusion Certificate on the Department's standard form included in the Proposal shall be executed.

The Certificate of Current Capacity shall be executed under oath and substantiated by the report of Status of Contracts on Hand.

The Bidder shall purchase from the GADOT Office of Construction Bidding Administration, a Valid for Bidding Proposal Form for each Letting Call Order Number in which the Bidder intends to submit a bid.

If the Proposal is made by an individual, its name and post office address shall be shown; if by a partnership, the name and post office address of one member of the partnership shall be shown; if by a corporation, the Proposal shall show the name, title and business address of the officer signing the Proposal. The Bidder's Proposal shall be signed in ink or by Digital Signature by the individual, by one or more members of a partnership, or by one or more of the officers of a corporation, whichever is applicable. In the event of a joint venture, the Proposal shall be signed in ink or by Digital Signature by each individual involved, by each partnership through one or more of its members, or by each corporation through one or more officers of the corporation, whichever is applicable. Proposals not properly signed may be disqualified and rejected.

All bids in excess of \$500,000 shall be submitted using the GADOT/AASHTO (American Association of State Highway and Transportation Officials) Electronic Bidding System (Expedite). When submitting a bid electronically, the Bidder's Proposal shall consist of the Bid pages generated by the Expedite software including the Cover page, Bid Item pages, Disadvantaged Business Enterprise (DBE) pages (if applicable), Miscellaneous Data pages and the Signature page. By submitting a bid electronically, the Bidder acknowledges that all requirements included in the hard copy proposal, amendments, plans, Standard Specifications, and Supplemental Specifications are a part of the Bid and Contract.

The electronic bid shall be submitted by one of the following methods:

A. Hand delivery of the electronic bid to the Department at the place specified in the Notice To Contractors.

The bid shall include the 3 ½ inch (90 mm) electronic diskette or CD Rom and the Bid pages described in paragraph seven, above.

B. Electronic Bid Submission via the Internet and Bid Express™.

(Note: The Bidder shall secure an account and a valid Digital Signature from Bid Express™ (www.bidx.com) in order to use this method.

Instructions for preparing and submitting bids by these two methods are as follows:

A. Hand Delivery of Bid to the Department

1. Access to the electronic bidding information is available on Bid Express™ at www.bidx.com and the GADOT Office of Construction Bidding Administration Internet Web Site at <http://wwwb.dot.state.ga.us/dot/construction/contractsadm/index.shtml>
2. Electronic bids shall be prepared through the use of a computer controlled printer.
3. The Bidder shall sign the electronic bid in the appropriate areas.
4. When installing the Bid program the Bidder shall enter their vendor code in the following format: 2DO900. Before running the electronic bidding programs, the Bidder shall read the on-line help documentation for the Expedite software.
5. **Zero (0) is considered to be a valid bid. The Bidder shall not enter 0 in any Unit Price field unless zero is the intended bid for that item.**
6. All addenda shall be included in the electronic bid submitted.
7. For “Joint Bids” the Bidder shall select **tools** from the Windows Expedite menu and mark the electronic bid as **“Joint Bid”**.
8. The Bidder shall select **tools** and then **check bid** to check the bid and assure there are no errors prior to printing the electronic bid. After final printing, the Bidder may make changes to the electronic bid by indicating the changes in ink and initialing prior to submitting the bid.
9. Once the Bidder has completed the bid and made all desired changes, the diskette/CD Rom, a printout of the Cover sheet, Bid Item pages, DBE pages (if applicable), Miscellaneous Data pages, and Signature page shall be submitted to the Department. In case of a discrepancy between the diskette and the hard copy of the Bid Item pages, the hard copy will govern.
10. Electronic Bid pages shall be 8 ½ inch (216 mm) horizontal by 11 inch (279 mm) vertical. Bid information shall be placed across the horizontal width on each page.
11. The paper used for an electronic bid shall be of sufficient quality and durability to maintain clear and concise images and to withstand frequent handling.
12. If originally printed on continuous roll paper, electronic bids shall be separated before submitting the Bid to the Department.
13. All computer printed characters shall be legible. The Electronic Bid pages shall be submitted in the bid envelope provided.
14. The diskette/ CD Rom shall be submitted in a separate sealed envelope from the Bid pages. The Bidder shall submit all electronic bids on one diskette/CD Rom. The envelope containing the diskette/CD Rom shall include the Bidders name and the Letting Call Order Numbers for which electronic bids are submitted.

B. Electronic Bid Submission Via The Internet And Bid Express™

1. Access to the electronic bidding information is available on Bid Express™ at www.bidx.com and the GADOT Construction Bidding Administration Internet Web Site at <http://wwwb.dot.state.ga.us/dot/construction/contractsadm/index.shtml>
2. When installing the Bid program the Bidder shall enter their vendor code in the following format: 2DO900. Before running the electronic bidding programs, the Bidder shall read the on-line help documentation for the Expedite software.
3. **Zero (0) is considered to be a valid bid. The Bidder shall not enter 0 in any Unit Price field unless zero is the intended bid for that item.**
4. All addenda shall be included in the electronic bid submitted.
5. **“Joint Bids” are allowed with Electronic Bid Submission via the Internet and Bid Express™**

6. The Bidder shall select **tools** and then **check bid** from the Windows Expedite menu to check the bid and assure there are no errors prior to submitting the electronic bid. The electronic bid may be changed and resubmitted electronically to Bid Express™ as many times as desired prior to the advertised cutoff time specified in the Notice To Contractors. The last bid submitted for a given Letting Call Order Number prior to the cutoff time will be the Bid.
7. The Bidder shall make no claim against the Department in the event it is unable to submit its bid to Bid Express™ and/or Bid Express™ is unable to submit the bid(s) to the Department. The Department reserves the right to postpone the public reading of bids in the event of technical difficulties.
8. A fully executed Proposal Guaranty and Power of Attorney for each Letting Call Order Number bid shall be submitted by one of the following methods:
 - A. Delivery to the GADOT Office of Construction Bidding Administration, Room 1934, in a sealed envelope by 12:00 noon on the day prior to the Bid Opening. Each Proposal Guaranty shall be clearly and legibly marked with the Letting Call Order Number.
 - B. Electronic submission via the Internet and Bid Express™ by the time and date set in the Notice To Contractors for submission of Proposals.

The Proposal Guaranty for a “Joint Bid” shall include the names of all Joint Venture parties involved in the bid.

Delete Subsection 102.07 and Substitute the following:

102.07 Rejection of Proposals

Proposals may be rejected as irregular if their consideration is conditioned upon the acceptance or rejection of other Proposals submitted by the same Bidder, if the Certificate of Current Capacity is not executed under Oath and substantiated, if a Unit Price is not shown for each Pay Item, or if they fail to comply with the EBS bidding requirements. In the case of alternate items, Unit Prices shall be entered for only one alternate. The Department reserves the right to disqualify and reject any Proposal that is not properly signed in accordance with the requisite of [Subsection 102.06](#).

A. Collusion

Any and all Proposals will be rejected if the Department believes that collusion exists among the Bidders and no participant in such collusion may submit future Proposals for the same work. The Department reserves the right to review and to refuse to consider any Proposal if the Bidder fails to execute the Non-Collusion Certificate.

B. Single Proposals

Only one Proposal from any person, partnership, or corporation under the same or different names shall be submitted on any Project.

C. Unbalanced Bids

Proposals may be rejected if any of the Unit Prices are obviously unbalanced. The Department will decide whether any Unit Prices are unbalanced either excessively above or below a reasonable cost analysis value determined by the Engineer, particularly if these unbalanced amounts are substantial and contrary to the interest of the Department.

D. Omissions and Alterations

Proposals may be rejected as irregular if they show any omissions, alterations of form, additions or conditions not called for, unauthorized alternate bids, erasures or changes not initialed, or other irregularities.

E. Debts

The Department reserves the right to reject Proposals from Bidders who have not paid or satisfactorily settled all legal debts due on other Contracts at the time Proposals are received.

F. Technicalities

The Department reserves the right to reject any and all Proposals and to waive technicalities at any time before the Contract has been signed by the Department.

G. Non-Prequalified Bidders

Proposals submitted in excess of \$2,000,000 by non-prequalified contractors under Rule 672-5 of the Department's Rules and Regulations Governing the Prequalification of Prospective Bidders will be disqualified and rejected.

H. Failure to List Disadvantaged Business Enterprise (DBE) Participants

If the contract has an established DBE goal, the Department reserves the right to reject and disqualify any proposal if the bidder has failed to list bona fide DBE participants with sufficient participation to achieve at least the established goal. The Department may consider for award a proposal with less participation than the established goal if both:

- The bidder can demonstrate that no greater participation could be obtained and;
- The participation proposed by the low bidder is not substantially less than the participation proposed by the other bidders on the same contract.

I. Non-responsive technical proposal

A proposal will only be considered non-responsive if it does not contain the information noted in paragraphs 2 and 3 of section 102.06, and any other information necessary to clearly demonstrate those assumptions used to form the basis of the bid. The technical proposal may be considered non-responsive if the bid or technical proposal contains any deviations from those items shown in the Scope (999.1.03) and applicable portions of the Plans Package.

Delete Subsection 102.09 and Substitute the following:

102.09 Delivery of Proposals

Each Proposal, together with the Proposal Guaranty, shall be submitted in a sealed envelope so marked as to identify its contents without being opened, unless submitted electronically (See Section 102.06). **In addition, Six (6) copies of the Bidder's technical proposal shall be submitted in a sealed envelope so marked as to identify its contents without being opened.** Proposal forms are not transferable. Proposals will be received until the time and date set in the Notice To Contractors and shall be in the hands of the officials indicated by that time. Proposals received after the advertised cutoff time established for submission of Proposals will be returned unopened to the Bidder.

Delete Subsection 102.10 and Substitute the following:

102.10 Withdrawal or Revision of Proposals

Any Bidder may withdraw his Proposal by submitting, by telegram, letter, or facsimile transmission received prior to the advertised cutoff time specified in the Notice To Contractors and verified by the Department, a DEPARTMENT OF TRANSPORTATION BID PROPOSAL WITHDRAWAL FORM, completed by an authorized officer of the company, whose signature is legally binding upon said company.

Any Bidder may submit a Bid change, by telegram, letter, or facsimile transmission received prior to the advertised cutoff time specified in the Notice To Contractors and verified by the Department, completed by an authorized officer of the company, whose signature is legally binding upon said company. In which case, the Department will change the Bid at the time of opening and at such time will announce that a change was received.

Add the following:

102.15 Submittal of "Certificate of Current Capacity" and "Status of Contracts on Hand"

The apparent low Bidder for each Letting Call Number shall submit the executed "Certificate of Current Capacity" and the "Status of Contracts on Hand" to the GADOT Office of Construction Bidding Administration, Room 1934, in a sealed envelope by 12:00 noon on the first working day after the Bid Opening.

If the "Certificate of Current Capacity" and the "Status of Contracts on Hand" are not delivered to the GADOT Office of Construction Bidding Administration, Room 1934, in a sealed envelope by 12:00 noon on the first working day after the Bid Opening, the Bid may be subject to disqualification.

**Department of Transportation
State of Georgia**

Supplemental Specification

Section 104 – Scope of Work

Delete Subsection 104.08 and Substitute the following:

104.08 Value Engineering Proposals

A. Applicability

This Section applies to those cost reduction proposals initiated and developed by the Contractor for changing the Plans, Specifications, or other requirements of the Contract. These provisions do not apply unless the proposal submitted by the Contractor is specifically identified as being presented as a Value Engineering Proposal (VEP) and the Contract amount is in excess of \$50,000.

The cost-reduction Proposals contemplated are those discretionary changes which would require a Supplemental Agreement modifying the Contract and would produce a savings to the Department by providing less costly items or methods than those specified in the Contract without impairing essential functions and characteristics including, but not limited to: service life, reliability, economy of operations, ease of maintenance, and safety, both during and after construction. Proposals must provide a product comparable to the original design at a lower cost or improved quality, or both. No proposals will be accepted that lower the quality of the project.

These provisions are applicable to the prime Contract and include all subcontracts.

B. Documentation

Value Engineering Proposals (VEP) will be processed in the same manner as prescribed for any other alterations of the Contract requiring a Supplemental Agreement.

As a minimum, the following information shall be submitted by the Contractor with each Value Engineering Proposal:

1. A description of the difference between the existing Contract requirement and the proposed change and the comparative advantages and disadvantages of each.
2. An itemization of the requirements of the Contract which must be changed and a recommendation of how to make such change (e.g., a suggested revision).
3. A detailed estimate of the cost of performing the work under the Contract and under the proposed change.
4. A prediction of any effects the proposed changes would have on other costs to the Department, including cost of related items and costs of maintenance and operation.
5. A statement of the time showing the last date by which an agreement for adoption of the proposed changes must be executed in order to obtain the maximum cost reduction during the remainder of the Contract, noting any effect on the Contract completion time or delivery schedule.
6. The dates of any previous or concurrent submissions of the Proposal, the Contract number(s) under which submitted, and the outcome or the result of the proposal in previous projects and any previous actions by the Department, if known.
7. A life-cycle cost analysis.

NOTE: If a VEP is similar to a change in the Plans or Specifications for the Project that is under consideration by the Department at the time said VEP is submitted, or if such VEP is based upon or similar to Standard Specifications, Special Provisions, or Standard Plans adopted by the Department after the advertisement of the Contract, the Engineer will not accept such proposal and the Department reserves the right to make such changes without compensation to the Contractor under the provisions of this Section.

Proposed changes in the basic design of a pavement type (e.g., rigid to flexible or vice versa) will not be considered as an acceptable VEP. Proposed changes to base/subbase courses may be considered as an acceptable VEP. If design alternates are shown in the plans, the Department will not consider a VEP substituting a design alternate on which the Contractor could have bid for one on which the Contractor has bid. The Department reserves the right to reject any VEP submitted requiring additional Right-of-Way.

C. Submission

Value Engineering Proposals submitted by the Contractor will be processed as expeditiously as possible; however, the Department will not be liable for any delay in acting upon proposals submitted. The Contractor may withdraw, wholly or in part, any VEP not accepted by the Department within the time specified in [Subsection 104.08.B.5](#).

D. Acceptance

The decision of the Engineer as to the acceptance or rejection of a VEP shall be final and shall not be subject to the provisions of [Subsection 105.13](#), "Claims for Adjustments and Disputes."

The Engineer may accept, in whole or in part, before work has been completed, any VEP submitted pursuant to this Subsection and not withdrawn by the Contractor by giving the Contractor written notice thereof reciting acceptance under this Subsection.

E. Notification

The Contractor will be notified in writing of the Department's decision or rejection of each VEP submitted under these provisions. If a proposal is accepted, the necessary Contract modifications will be affected by execution of a Supplemental Agreement. Unless and until a VEP is affected by such Supplemental Agreement, the Contractor shall remain obligated to perform The Work in accordance with the terms of the existing Contract.

Supplemental Agreements made as a result of this Subsection will state that they are made pursuant to it.

F. Sharing

In the event a VEP submitted by the Contractor under this Subsection is accepted, the Supplemental Agreement effecting the necessary modifications will establish the net savings agreed upon and will provide for an adjustment in Contract Prices that will divide the net savings between the Contractor and the Department in accordance with the following provisions:

1. Division of net savings in Contract Price Adjustment:
 - 50 percent of the net savings to the Contractor.
 - 50 percent of the net savings to the Department.
2. The Department reserves the right to include in the agreement any conditions it deems appropriate for consideration, approval, and implementation of the VEP. The Contractor's 50 percent of the net savings shall constitute the full compensation for effecting all changes pursuant to the agreement.

Development costs incurred by the Contractor and review costs incurred by the Department shall not be considered in computing the net savings of the VEP.
3. Restrictions and Disclosures: Upon acceptance and implementation of any VEP, any restrictions imposed by the Contractor on its use or disclosure of the information submitted shall be void.

The Department shall thereafter have the right to use, duplicate, and disclose, in whole or in any part, all data necessary in the utilization of the proposal.

Georgia Department of Transportation

State of Georgia

Supplemental Specification

Project Number: CSNHS-0008-00(415)

P.I. Number: 0008415

Fulton County

Section 107—Legal Regulations and Responsibility to the Public

Delete Subsection 107.23 and Substitute the following:

107.23 Environmental Considerations

A. Construction

Erosion control measures shall be installed, to the greatest practical extent, prior to clearing and grubbing. Particular care shall be exercised along stream banks, wetlands and other sensitive areas to insure that these areas are not adversely affected.

Construction equipment shall not cross streams, rivers, or other waterways except at temporary stream crossing structures approved by the Engineer.

Construction activities within wetland areas are prohibited except for those within the construction limits as shown on the Plans and as specified in Subsection 107.23.E.

All sediment control devices (except sediment basins) installed on a project shall, as a minimum, be cleaned of sediment when one half the capacity, by height, depth or volume, has been reached. Sediment basins shall be cleaned of sediment when one-third the capacity by volume has been reached.

B. Bridge Construction Over Waterways

Construction waste or debris, from bridge construction or demolition, shall be prevented from being allowed to fall or be placed into wetlands, streams, rivers or lakes.

Excavation, dewatering, and cleaning of cofferdams shall be performed in such a manner as to prevent siltation. Pumping from cofferdams to a settling basin or a containment unit will be required if deemed necessary by the Engineer.

Operations required within rivers or streams, i.e. jetting or spudding, shall be performed within silt containment areas, cofferdams, silt fence, sediment barriers or other devices to minimize migration of silt off the project.

C. Borrow and Excess Material Pits

Specific written environmental clearance from the Engineer will be required for any sites not included in the Plans as excess material or borrow areas. No work other than testing shall be started at any potential excess material or borrow site not shown on the plans prior to receiving said environmental clearance from the Engineer.

The Engineer will require a written notice from the Contractor requesting environmental clearance studies and written permission from the property owner at least six weeks prior to intended use of the site. The Department will not begin studies on such sites before a Notice to Proceed is issued.

The Engineer will inform the Contractor in writing as to the granting or denial of environmental clearance. If denied, the Contractor may, at no expense to the Department, seek to obtain permits or pursue other remedies that might otherwise render the site(s) acceptable.

Sites included in the Plans have environmental clearance and shall be used only for the purpose(s) specified in the Plans or other contract documents. Should the Contractor wish to expand or utilize said sites for any purpose other than that provided for in the Plans or other contract documents, specific written environmental clearance as noted above shall be obtained.

D. Control of Pollutants

Pollutants or potentially hazardous materials, such as fuels, lubricants, lead paint, chemicals or batteries, shall be transported, stored, and used in a manner to prevent leakage or spillage into the environment. The Contractor shall also be responsible for proper and legal disposal of all such materials.

Equipment, especially concrete or asphalt trucks, shall not be washed or cleaned-out on the Project except in areas where unused product contaminants can be prevented from entering waterways.

E. Temporary Work in Wetlands Outside of the Construction Limits within the Right-of-Way and Easement Areas

Temporary work in wetlands (that are not Environmentally Sensitive Areas) in order to facilitate construction will be subject to the following requirements:

1. Temporary work in wetlands shall be accomplished by using temporary structures, timber, concrete, soil with geotextile fabric, or other suitable matting. The area shall not be grubbed.
2. Soil matting shall be protected from erosion in accordance with the Specifications.
3. Whenever temporary work is required in Saltwater Marsh Wetlands, all temporary structures and/or matting shall be removed in their entirety prior to Final Acceptance of the Project. Matted and compressed soils shall be backfilled to their original ground elevation with material meeting the requirements of [Section 212 – Granular Embankment](#).
4. Whenever temporary work is required in Freshwater Wetlands, all temporary structures and/or matting (exclusive of soil matting to be retained in the final roadway section) shall be removed in their entirety prior to Final Acceptance of the Project.

Once the temporary materials have been removed, the area shall be covered by Excelsior or Straw blankets according to [Section 713](#) of the Specifications. The grassing and ground preparation referenced in [Subsection 713.3.03, “Preparation”](#), will not be applicable to this Work.

5. The Engineer shall be notified so that a field inspection may be conducted to certify that the temporary materials were properly removed and that the area was properly restored. The Contractor shall be responsible for any corrective action required to complete this Work.
6. There will be no separate measurement or payment for this Work. The cost associated with this work shall be included in the overall Bid submitted.

F. Environmentally Sensitive Areas

Some archaeological sites, historic sites, wetlands, streams, open waters and protected animal and plant species habitats within the Right-of-Way and easement areas may be designated as ENVIRONMENTALLY SENSITIVE AREAS (ESAs). These areas are shown on the Plan sheets and labeled “ESA” (e.g. ESA – Historical Boundary, ESA – Wetland Boundary). The Contractor shall install orange barrier fence as delineated in the Plans.

The Contractor shall not perform any construction related activities within areas delineated in the Plans with orange barrier fence, unless specifically stated otherwise in the Plans. This includes but is not limited to construction activities such as clearing and grubbing, borrowing, wasting, grading, filling, staging, parking, sediment basins, and equipment storage. Also, all archaeological sites, historic sites, wetlands, streams and protected habitats beyond the Right-of-Way and easement areas are deemed to be ENVIRONMENTALLY SENSITIVE AREAS and shall not be disturbed in any way.

The orange barrier fence shall remain in place until such time the Engineer directs the fence to be removed. The cost of this work shall be included in the Bid price submitted for CONSTRUCTION COMPLETE. Includes all materials, construction, and removal.

Date: March 13, 2007
Revised: May 3, 2007
Revised: April 8, 2008
Revised: October 8, 2008

**DEPARTMENT OF TRANSPORTATION
STATE OF GEORGIA

SPECIAL PROVISION**

Section 109—Measurement and Payment

Delete Subsection 109.07A. and Substitute the following:

A. General

At the end of each calendar month, the total value of Items complete in place will be estimated by the Engineer and certified for payment. Such estimate is approximate only and may not necessarily be based on detailed measurements. Value will be computed on the basis of Contract Item Unit Prices or on percentage of completion of Lump Sum Items.

When so requested by the Contractor and approved by the Engineer, Gross Earnings of \$500,000.00 or more for work completed within the first 15 days of any month will be certified for payment on a semi-monthly basis subject to the conditions and provisions of Subsection 109.07.A, Subsection 109.07.B.6, Subsection 109.07.C, Subsection 109.07.D, Subsection 109.07.E, and Subsection 109.07.F.

Delete Subsection 109.07B.4 and Substitute the following:

No materials allowance will be made for a material when the requested allowance for such material is less than \$50,000.00.

**DEPARTMENT OF TRANSPORTATION
STATE OF GEORGIA**

SPECIAL PROVISION

Project Number: CSNHS-0008-00(415)

P.I. Number: 0008415

Fulton County

Section 149 – Construction Layout

Delete Subsection 149.3.05.I and substitute the following:

I. Maintain the Stakes

After construction has begun in any segment of the Project, maintain the stakes that identify construction station numbers and locations as follows:

1. Ensure that stakes are placed at intervals not to exceed 200 ft (60 m) and use even, 100 ft (30 m) stations. On asphalt shoulder widening and earth shoulder reconstruction projects use mile post numbers when stations are not used.

Mark and flag stakes so that they are visible to DOT Project personnel in that segment of the Project until construction is complete.

Projects utilizing GPS controlled fine grading equipment, place stakes at intervals not to exceed 300 ft (91 m) on English projects and 100 m (310 ft) on metric projects. Use even, 100 ft (30 m) or 100 m (310 ft), stations.

2. During grading activities in fills or cuts over 20 ft (6 m), extend slope stakes up or down the slopes in intervals of 10 ft (3 m) or less to achieve an accurate cross section.
3. Denote the offset distance to the construction centerline on the station number stakes, when the station number is maintained in a location other than on the construction centerline. On asphalt shoulder widening and earth shoulder reconstruction projects use the offset to the edge of pavement on the stakes.

Office of Materials & Research

Rev. July 1, 2003
April 15, 2004
October 11, 2005
October 25, 2005
February 10, 2006
April 20, 2006
May 8, 2007
September 18, 2007
December 1, 2008

**DEPARTMENT OF TRANSPORTATION
STATE OF GEORGIA**

**Project Number: CSNHS-0008-00(415)
P.I. Number: 0008415
Fulton County**

SPECIAL PROVISION

Section 150—Traffic Control

Add the following:

150.01 GENERAL

This section as supplemented by the Plans, Specifications, and Manual on Uniform Traffic Control Devices (MUTCD) shall be considered the Temporary Traffic Control (TTC) Plan. Activities shall consist of furnishing, installing, maintaining, and removing necessary traffic signs, pedestrian signs, barricades, lights, signals, cones, pavement markings and other traffic control devices and shall include flagging and other means for guidance and protection of vehicular and pedestrian traffic through the Work Zone. This Work shall include both maintaining existing devices and installing additional devices as necessary in construction work zones.

When any provisions of this Specification or the Plans do not meet the minimum requirements of the MUTCD, the MUTCD shall control. The 2003 Edition of the MUTCD shall be in effect for the duration of the project.

The needs and control of all road users (motorists, bicyclists and pedestrians within the highway right-of-way and easements, including persons with disabilities in accordance with the Americans with Disabilities Act of 1990 (ADA), Title II, Paragraph 35.130) through a Temporary Traffic Control (TTC) zone shall be an essential part of highway construction, utility work, maintenance operations and management of traffic incidents.

The Worksite Traffic Control Supervisor (WTCS) shall have a copy of Part VI of the MUTCD and the Contract on the job site. Copies of the current MUTCD may be obtained from the FHWA web page at <http://mutcd.fhwa.dot.gov>.

A. WORKER SAFETY APPAREL

All workers exposed to the risks of moving roadway traffic or construction equipment shall wear high-visibility safety apparel meeting the requirements of International Safety Equipment Association (ISEA) American National Standard for High-Visibility Safety Apparel, or equivalent revisions, and labeled as ANSI-2004 Class 2 or 3 risk exposure.

B. WORKSITE TRAFFIC CONTROL SUPERVISOR

ALL HIGHWAYS (ADDITIONAL REQUIREMENTS BELOW FOR INTERSTATES): The Contractor shall designate a qualified individual as the Worksite Traffic Control Supervisor (WTCS) who shall be responsible for selecting, installing and maintaining all traffic control devices in accordance with the Plans, Specifications, Special Provisions and the MUTCD. A written resume documenting the experience and credentials of the WTCS shall be submitted and accepted by the Engineer prior to beginning any work that involves traffic control. The WTCS shall be available on a twenty-four (24) hour basis to perform his duties. If the work requires traffic control activities to be performed during the daylight and nighttime hours it may be necessary for the Contractor to designate an alternate WTCS. An alternate WTCS must meet the same requirements and qualifications as the primary WTCS and be accepted by the Engineer prior to beginning any traffic control duties. The Worksite Traffic Control Supervisor's traffic control responsibilities shall have priority over all other assigned duties.

As the representative of the Contractor, the WTCS shall have full authority to act on behalf of the Contractor in administering the TTC Plan. The WTCS shall have appropriate training in safe traffic control practices in accordance with Part VI of the MUTCD. In addition to the WTCS all other individuals making decisions regarding traffic control shall meet the training requirements of the Part VI of the MUTCD.

The WTCS shall supervise the initial installation of traffic control devices. The Engineer prior to the beginning of construction will review the initial installation. Modifications to traffic control devices as required by sequence of operations or staged construction shall be reviewed by the WTCS.

The WTCS shall be available on a full-time basis to maintain traffic control devices with access to all personnel, materials, and equipment necessary to respond effectively to an emergency situation within forty-five (45) minutes of notification of the emergency.

The WTCS shall regularly perform inspections to ensure that traffic control is maintained. Unless modified by the special conditions or by the Engineer, routine deficiencies shall be corrected within a twenty-four (24) hour period. Failure to comply with these provisions shall be grounds for dismissal from the duties of WTCS and/or removal of the WTCS from the project. Failure of the WTCS to execute his duties shall be considered as non-performance under [Subsection 150.08](#).

The Engineer will periodically review the work for compliance with the requirements of the TTC plan.

On projects where traffic control duties will not require full time supervision, the Engineer may allow the Contractor's Project Superintendent to serve as the WTCS as long as satisfactory results are obtained.

CERTIFIED WORKSITE TRAFFIC CONTROL SUPERVISOR

ADDITIONAL REQUIREMENTS FOR INTERSTATE AND LIMITED ACCESS HIGHWAYS: In addition to the requirements above, the WTCS shall have a minimum of one year's experience directly related to work site traffic control in a supervisory or responsible capacity. The WTCS shall be currently certified by the American Traffic Safety Services Association (ATSSA) Work Site Traffic Supervisor Certification program or the National Safety Council Certification program.

Any work performed on the interstate or limited access highway right-of-way that requires traffic control shall be supervised by the Certified Worksite Traffic Control Supervisor. No work requiring traffic control shall be performed unless the certified WTCS is on the worksite. Failure to maintain a Certified Worksite Traffic Control Supervisor on the work will be considered as non-performance under [Subsection 150.08](#).

The WTCS shall perform, as a minimum, weekly traffic control inspections on all interstate and limited access highways. The inspection shall be reported to the Engineer on a TC-1 report. The Engineer will furnish a blank copy of the TC-1 report to the Contractor prior to the beginning of any work on the interstate or limited access right-of-way.

C. TRAFFIC CONTROL DEVICES

All traffic control devices used during the construction of a project shall meet the Standards utilized in the MUTCD, and shall comply with the requirements of these Specifications, Project Plans, and Special Provisions. All devices shall be tested at NCHRP Test Level III. Reference is made to [Subsections 104.05](#), [107.07](#), and [107.09](#).

D. REFLECTORIZATION REQUIREMENTS

All rigid fluorescent orange construction warning signs (black on fluorescent orange) shall meet the reflectorization and color requirements of ASTM Type VII, VIII, IX or X regardless of the mounting height.

Portable signs which have flexible sign blanks shall meet the reflectorization and color requirements of ASTM Type VI.

Warning signs (W3-1a) for stop conditions that have rumble strips located in the travelway shall be reflectorized with ASTM Type IX fluorescent yellow sheeting.

All other signs shall meet the requirements of ASTM Type III or IV except for "Pass With Care" and "Do Not Pass" signs which may be ASTM Type I unless otherwise specified.

CHANNELIZATION DEVICES: Channelization devices shall meet the requirements of ASTM Type III or IV high intensity sheeting.

E. IMPLEMENTATION REQUIREMENTS

No work shall be started on any project phase until the appropriate traffic control devices have been placed in accordance with the Project requirements. Changes to traffic flow shall not commence unless all labor, materials, and equipment necessary to make the changes are available on the Project.

When any shift or change is made to the location of traffic or to the flow patterns of traffic, including pedestrian traffic, the permanent safety features shall be installed and fully operational before making the change. If staging or site conditions prevent the installation of permanent features then the equivalent interim devices shall be utilized. This work shall also include any necessary removal and reinstallation of guardrail panels to achieve the required panel lap to accommodate the appropriate shift and traffic flow including the final traffic flow configuration (The cost of performing this work shall be included in Traffic Control-Lump Sum).

Any section of the work that is on new location shall have all permanent safety features installed and fully operational before the work is opened to traffic. Safety features shall include but are not limited to the following items:

1. Guardrail including anchors and delineation with properly lapped panels
2. Impact attenuators
3. Traffic signals
4. Warning devices
5. Pavement markings including words, symbols, stop bars, and crosswalks
6. Roadway signs including regulatory, warning, and guide

Outdoor lighting shall be considered as a safety feature for welcome centers, rest areas, and weigh station projects. For typical roadway type projects new street lighting is not considered a safety feature unless specifically noted in the plans or in the special conditions.

F. MAINTENANCE OF TRAFFIC CONTROL DEVICES

Traffic control devices shall be in acceptable condition when first erected on the project and shall be maintained in accordance with [Subsection 104.05](#) throughout the construction period. All unacceptable traffic control devices shall be replaced within 24 hours. When not in use, all traffic control devices shall be removed, placed or covered so as not to be visible to traffic. All construction warning signs shall be removed within seven calendar days after time charges are stopped or pay items are complete. If traffic control devices are left in place for more than ten days after completion of the Work, the Department shall have the right to remove such devices, claim possession thereof, and deduct the cost of such removal from any monies due, or which may become due, the Contractor.

G. TRAFFIC INTERRUPTION RESTRICTIONS

The Department reserves the right to restrict construction operations when, in the opinion of the Engineer, the continuance of the Work would seriously hinder traffic flow, be needlessly disruptive or unnecessarily inconvenience the traveling public. The Contractor shall suspend and/or reschedule any work when the Engineer deems that conditions are unfavorable for continuing the Work.

Advanced notification requirements to the Contractor to suspend work will be according to the events and the time restrictions outlined below:

Incident management	No advanced notice required
Threatening/Inclement weather	24 hours

Holidays, sporting events,
unfavorable conditions

Three (3) calendar days

If the work is suspended, the Contractor may submit a request for additional contract time as allowed under Section 108. The Department will review the request and may grant additional contract time as justified by the impact to the Contractor's schedule. Compensation for loss of productivity, rescheduling of crews, rental of equipment or delays to the Contractor's schedule will not be considered for payment. Additional contract time will be the only consideration granted to the Contractor.

H. SEQUENCE OF OPERATIONS

Any Sequence of Operations provided in this Contract in conjunction with any staging details which may be shown in the plans, is a suggested sequence for performing the Work. It is intended as a general staging plan for the orderly execution of the work while minimizing the impact on pedestrian facilities, mainline, cross-streets and side streets. The Contractor shall develop detailed staging and temporary traffic control plans for performing specific areas of the Work including but not limited to all traffic shifts, detours, bridge widenings, paces, or other activities that disrupt traffic or pedestrian flow. The Engineer may require detailed staging and TTC plans for lane closures or disruption to pedestrian facilities. These plans shall be submitted for approval at least two weeks prior to the scheduled date of the activity. Activities that have not been approved at least seven (7) days prior to the scheduled date shall be rescheduled.

Where traffic is permitted through the work area under stage construction, the Contractor may choose to construct, at no additional expense to the Department, temporary on-site bypasses or detours in order to expedite the work. Plans for such temporary bypasses or detours shall be submitted to the Engineer for review and approval 30 calendar days prior to the proposed construction. Such bypasses or detours shall be removed promptly when in the opinion of the Engineer; they are no longer necessary for the satisfactory progress of the Work. Bypasses and detours shall meet the minimum requirements of [Section 150.02.B.4](#).

As an option to the Sequence of Operations in the Contract, the Contractor may submit an alternative Sequence of Operations for review and approval. Alternate Sequence of Operations for pedestrian facilities shall be in compliance with the MUTCD and ADA. Pedestrian needs identified in the preconstruction phase shall be included in the proposed alternate plan. The Department may consider the Contractor's alternate Sequence of Operations as a Value Engineering Proposal as defined by [Section 104.08](#). A twenty calendar days lead time for the Department's review shall be given to this submission so that a decision on its acceptability can be made and presented at the Preconstruction Conference. Insufficient lead time or no submission by the Contractor shall be construed as acceptance of the Sequence of Operations outlined in the Contract and the willingness of the Contractor to execute this as-bid plan.

The Department will not pay, or in any way reimburse the Contractor for claims arising from the Contractor's inability to perform the Work in accordance with the Sequence of Operations provided in the Contract or from an approved Contractor alternate.

The Contractor shall secure the Engineer's approval of the Contractor's proposed plan of operation, sequence of work and methods of providing for the safe passage of vehicular and pedestrian traffic before it is placed in operation. The proposed plan of operation shall supplement the approved traffic control plan. Any major changes to the approved TTC plan, proposed by the Contractor, shall be submitted to the Department for approval.

Some additional traffic control details will be required prior to any major shifts or changes in traffic. The traffic control details shall include, but not be limited to, the following:

1. A detailed drawing showing traffic locations and laneage for each step of the change.
2. The location, size, and message of all signs required by the MUTCD, Plan, Special Provisions, and other signs as required to fit conditions. Any portable changeable message signs used shall be included in the details.
3. The method to be used in, and the limits of, the obliteration of conflicting lines and markings.
4. Type, location, and extent of new lines and markings.
5. Horizontal and vertical alignment and superelevation rates for detours, including cross-section and profile grades along each edge of existing pavement.
6. Drainage details for temporary and permanent alignments.
7. Location, length, and/or spacing of channelization and protective devices (temporary barrier, guardrail, barricades, etc.)
8. Starting time, duration and date of planned change.
9. For each traffic shift, a paving plan, erection plan, or work site plan, as appropriate, detailing workforce, materials, and equipment necessary to accomplish the proposed work. This will be the minimum resource allocation required in order to start the work.

A minimum of three copies of the above details shall be submitted to the Engineer for approval at least 14 days prior to the anticipated traffic shift. The Contractor shall have traffic control details for a traffic shift which has been approved by the Engineer prior to commencement of the physical shift. All preparatory work relative to the traffic shift, which does not interfere with traffic, shall be accomplished prior to the designated starting time. The Engineer and the Contractor's representative will verify that all conditions have been met prior to the Contractor obtaining materials for the actual traffic shift.

150.02 TEMPORARY TRAFFIC CONTROL (TTC) ZONES:

A. DEVICES AND MATERIALS:

In addition to the other provisions contained herein, work zone traffic control shall be accomplished using the following means and materials:

1. Portable Advance Warning Signs

Portable advance warning signs shall be utilized as per the requirements of the temporary traffic control plans. All signs shall meet the requirements of the MUTCD and shall be NCHRP 350 crashworthy compliant.

2. Arrow Panels

Portable sequential or flashing arrow panels as shown in the Plans or Specifications for use on Interstate or multi-lane highway lane closure only, shall be a minimum size of 48" high by 96" wide with not less than 15 lamps used for the arrow. The arrow shall occupy virtually the entire size of the arrow panel and shall have a minimum legibility distance of one mile. The minimum legibility distance is that distance at which the arrow panel can be comprehended by an observer on a sunny day, or clear night. Arrow panels shall be equipped with automatic dimming features for use during hours of darkness. The arrow panels shall also meet the requirements for a Type C panel as shown in the MUTCD. The sequential or flashing arrow panels shall not be used for lane closure on two-lane, two-way highways when traffic is restricted to one-lane operations in which case, appropriate signing, flaggers and when required, pilot vehicles will be deemed sufficient.

The sequential or flashing arrow panels shall be placed on the shoulder at or near the point where the lane closing transition begins. The panels shall be mounted on a vehicle, trailer, or other suitable support. Vehicle mounted panels shall be provided with remote controls. Minimum mounting height shall be seven feet above the roadway to the bottom of the panel, except on vehicle mounted panels which should be as high as practical.

For emergency situations, arrow display panels that meet the MUTCD requirements for Type A or Type B panels may be used until Type C panels can be located and placed at the site. The use of Type A and Type B panels shall be held to the minimum length of time possible before having the Type C panel(s) in operation. The Engineer shall determine when conditions and circumstances are considered to be emergencies. The Contractor shall notify the Engineer, in writing, when any non-specification arrow display panel(s) is being used in the work.

3. Portable Changeable Message Signs

Portable changeable message signs meeting the requirements of [Section 632](#) and the MUTCD. Any PCMS in use that is not protected by positive barrier protection shall be delineated by a minimum of three drums that meet the requirement of Section 150.05.A.1. The drum spacing shall not exceed a maximum of ten (10') feet as shown in [Detail 150-PCMS](#). When the PCMS is within twenty (20') feet of the opposing traffic flow, the trailing end of the PCMS shall be delineated with a minimum of three drums spaced in the same manner as the approach side of the PCMS.

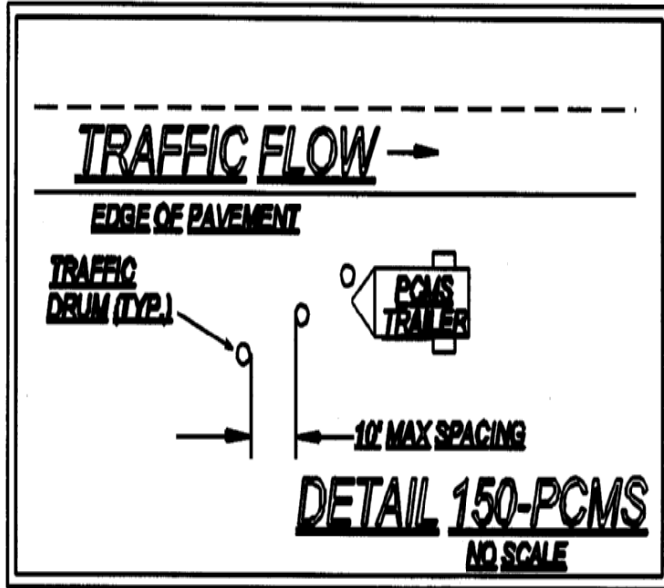

When not in use the PCMS shall be removed from the roadway unless protected by positive barrier protection. If the PCMS is protected by positive barrier protection the sign panel shall be turned away from traffic when not in use.

4. Channelization Devices

Channelization devices shall meet the standards of the MUTCD and [Subsection 150.05](#).

5. Temporary Barrier

Temporary barrier shall meet the requirements of [Sections 620](#).

6. Temporary Traffic Signals

Temporary traffic signals shall meet the requirements of [Section 647](#) and the MUTCD.

7. Pavement Marking

Pavement marking incorporated into the work shall comply with [Subsections 150.04.A](#) and [150.04.B](#).

8. Portable Temporary Traffic Control Signals

The use off Portable Temporary Traffic Control Signals shall meet the following minimum requirements:

Only two-lane two-way roadways will be allowed to utilize Portable Temporary Traffic Control Signals.

All portable traffic control signals shall meet the physical display and operational requirements of conventional traffic signals described in the MUTCD.

Each signal face shall have at least three lenses. The lenses shall be red, yellow, or green in color and shall give a circular type of indication. All lenses shall be twelve (12") inches nominal in diameter.

A minimum of two signal faces shall face each direction of traffic. A minimum of one signal head shall be suspended over the roadway travel lane in a manner that will allow the bottom of the signal head housing to be not less than seventeen (17') feet above and not more than nineteen (19') feet above the pavement grade at the center of the travel lane. The second signal head may be located over the travel lane with the same height requirements or the second signal head may be located on the shoulder. When the signal head is located on the shoulder the bottom of the signal head housing shall be at least eight (8') feet but not more than (15') feet above the pavement grade at the center of highway.

Advance warning signage and appropriate pavement markings shall be installed as part of the temporary signal operation.

The signals shall be operated in a manner consistent with traffic requirements. The signals may be operated in timed-mode or in a vehicle-actuated mode. The signals shall be interconnected in a manner to ensure that conflicting movements can not occur. To assure that the appropriate operating pattern including timing is displayed to the traveling public, regular inspections including the use of accurate timing devices shall be made by the Worksite Traffic Control Supervisor. If at any time any part of the system fails to operate within these requirements then the use of the signal shall be suspended and the appropriate flagging operation shall begin immediately.

The Worksite Traffic Control Supervisor (WTCS) shall continuously monitor the portable traffic control signal to insure compliance with the requirements for maintenance under the MUTCD. The signal shall be maintained in a manner consistent with the intention of the MUTCD, with emphasis on cleaning of the optical system. Timing changes shall be made only by the WTCS. The WTCS shall keep a written record of all timing changes.

The portable temporary signal shall have two power sources and shall be capable of running for seven calendar days continuously.

The Contractor shall have an alternate temporary traffic control plan in the event of failure of the signal.

9. RUMBLE STRIPS

Rumble strips incorporated into the work shall meet the requirements of [Section 429](#) and the MUTCD. Existing rumble strips that are positioned in the traveled way to warn traffic of a stop condition shall be reinstalled based on the following requirements:

INTERMEDIATE SURFACES: Intermediate surfaces that will be in use for more than forty-five (45) calendar days shall have rumble strips reinstalled on the traveled way in the area of a stop condition. Non-refundable deductions in accordance with [150.08](#) will be assessed for any intermediate surface in place for greater than 45 days without rumble strips.

FINAL SURFACES: Rumble strips shall be installed on the final surface within fourteen (14) calendar days of the placement of the final surface in the area of the stop condition. Failure to install within fourteen (14) calendar days will result in assessment of non-refundable deductions in accordance with [150.08](#).

Prior to the removal of any rumble strips located in the travelway, stop ahead (W3-1a) warning signs shall be double indicated ahead of the stop condition. These warning signs shall be a minimum of 48 inches by 48 inches. The reflectorization of the warning signs shall be as required by [Subsection 150.01.C](#). These warning signs shall remain in place until the rumble strips have been reinstalled on the traveled way. Any existing warning signs for the stop ahead condition shall be removed or covered while the 48" X 48" (W3-1a) signs are in place. When the rumble strips have been reinstalled these warning signs should be promptly removed and any existing signage placed back in service.

10. GUARDRAIL: When the removal and installation of guardrail is required as a part of the work the following time restrictions shall apply unless modified by the special conditions:

MULTI-LANE HIGHWAYS: From the time that the existing guardrail or temporary positive barrier protection is removed the Contractor has fourteen (14) calendar days to install the new guardrail and anchors. During the interim, the location without guardrail shall be protected with drums spaced at a maximum spacing of twenty (20') feet. The maximum length of rail that can be removed at any time without being replaced with positive barrier protection is a total of 2000 linear feet of existing rail or the total length of one run of existing rail, whichever is less.

ALL OTHER HIGHWAYS: From the time that the existing guardrail is removed or from the time that temporary positive barrier protection is removed the Contractor has thirty (30) calendar days to install the new guardrail and anchors. During the interim, the location without guardrail shall be protected with drums spaced at a maximum spacing of twenty (20') feet. The maximum length of rail that can be removed at any time without being replaced with positive barrier protection is a total of 1000 linear feet of existing rail or the total length of one run of existing rail, whichever is less.

Based on existing field conditions, the Engineer may review the work and require that the guardrail be installed earlier than the maximum time allowed above by giving written notification to the Contractor via the TC-1 traffic control report.

ALL HIGHWAYS: The contractor shall install new guardrail such that traffic exposure to fixed objects is minimized. Within the same work day, temporary attenuators, as defined in [Subsection 150.05.B](#), should be installed on the approach to fixed objects that can't be protected with guardrail. Truck mounted attenuators may be used to shield exposed fixed objects for periods not to exceed forty-eight (48) hours. No separate payment will be made for truck mounted attenuators used in lieu of temporary attenuators.

When the roadway is open to traffic, guardrail panels shall be lapped to comply with the directional flow of traffic. Should the staging of the work require that the lap of the guardrail be changed, this work shall be completed before the roadway is opened to traffic. The work to change the lap of any guardrail shall be included in Traffic Control-Lump Sum.

Failure to comply with the above time and quantity restrictions shall be considered as non-compliance under Section 150.08.

11. STOP SIGN REGULATED INTERSECTIONS: For intersections that utilize stop sign(s) to control the flow of traffic and to restrict the movement of vehicles, the stop sign(s) shall be maintained for the duration of the work or until such time that the stop condition is eliminated or until an interim or permanent traffic signal can be installed to provide proper traffic control. The traffic signal shall be installed and properly functioning before the removal of the existing stop sign(s) is permitted. If the existing intersection is enhanced traffic control features such as stop bars, double indicated stop signs, oversized signs, advanced warning stop ahead signs, rumble strips on the approaches or flashing beacons located overhead or on the shoulders then these features shall be maintained for the duration of the project or until the permanent traffic control plan has been implemented.

Whenever the staging of the work requires that the traveled-way be relocated or realigned the Contractor shall reinstall all enhanced traffic control features noted above on the newly constructed sections of the work. The cost of relocating the stop bars, stop signs, advanced warning signs, the rumble strips and the flashing beacons shall be included in the price bid for Lump-Sum-Traffic Control unless individual pay items are included in the contract for rumble strips and/or flashing beacons. When pay items are included in the contract for rumble strips or flashing beacons then these items will be paid per each.

When staging requires the relocation or realignment of an existing stop condition it may be necessary to consider the addition of enhanced traffic control features even though none existed at the original location. As a guide for enhanced traffic control features that may be considered, the Engineer or the WTCS may refer to the Department's guidelines for "Opening of New Roadways to Traffic" (Document #6635-2). Horizontal and vertical alignment changes at a new location may have decreased or restricted sight distance or the stop condition may occur sooner than in the previous alignment. If these conditions occur then the Engineer and/or the WTCS should consider additional measures to enhance the motorist's awareness of the changes even though the staging plans may not address enhanced features. Stop signs should be a minimum of 36 inches for interim situations. The use of 48 inch stop signs may be warranted under project specific conditions. Flags may be used on interim/permanent stop signs that are mounted at seven (7') feet in height for a short duration in order to direct additional attention to a new or relocated stop sign(s). Flags should not be used for durations exceeding two weeks unless unusual or site specific conditions warrant a longer period of time. The use of Type "A" flashing red light(s) attached to the stop sign(s) may be appropriate during the same period that the flags are in use to increase attention.

The use of rumble strips and/or portable changeable message signs may be considered. The use of new rumble strips, where none previously existed, shall have the prior approval of District Traffic Operations before being included as part of the temporary traffic control plan. The message(s) displayed on any PCMS shall have the prior approval of the Engineer and the message(s) shall be included as part of the TTC plan for the interim staging.

The placement of any additional interim ground-mounted signs and posts or stop bars shall be considered as incidental to the price bid for Lump Sum-Traffic Control. The installation of rumble strips, flashing beacons or the use of Portable Changeable Message Signs (PCMS) shall be considered as Extra Work unless pay items are included in the contract.

B. WORK ZONE RESTRICTIONS:

1. Interstate

The Contractor shall not simultaneously perform work on both the inside shoulder and outside shoulder on either direction of traffic flow when the Work is within 12 feet of the travel-way, unless such areas are separated by at least one-half mile of distance.

2. Non-Interstate Divided Highways

The Contractor shall not simultaneously perform work on both the inside shoulder and outside shoulder on either direction of traffic flow when the Work is within 12 feet of the travel-way, unless such areas are separated by at least one-half mile distance in rural areas or at least 500 feet of distance in urban areas.

3. Non-Divided Highways

- a. The Contractor shall not simultaneously perform work on opposite sides of the roadway when the work is within 12 feet of the travel-way, unless such areas are separated by at least one-half mile of distance in rural areas or at least 500 feet of distance in urban areas.
- b. On two-lane projects where full width sections of the existing subgrade, base or surfacing are to be removed, and new base, subgrade, or surfacing are to be constructed, the Contractor shall maintain one-lane traffic through the construction area by removing and replacing the undesirable material for half the width of the existing roadway at a time. Replacement shall be made such that paving is completed to the level of the existing pavement in the adjacent lane by the end of the workday or before opening all the roadway to traffic.

4. All Highways:

- a. There shall be no reduction in the total number of available traffic lanes that existed prior to construction except as specifically allowed by the Contract and as approved by the Engineer.
- b. Travelway Clearances: All portions of the work shall maintain the following minimum requirements:

Horizontal: The combined dimensions of the paved shoulder and the roadway surface remaining outside the Work Zone shall be no less than sixteen (16) feet in width at any location.

Vertical: The overhead clearance shall not be reduced to less than fifteen (15) feet at any location.

The restrictions above apply to all shifts, lane closures, on-site detours and off site detours whether shown in the contract or proposed by the Contractor. It shall be

the responsibility of the Contractor to verify that these minimum requirements have been met before proceeding with any phase of the Work.

Two-lane two-way roadways may have temporary horizontal restrictions of less than sixteen (16) feet provided a flagger operation for one-way traffic is utilized to restrict access to the work area by over-width loads. The minimum horizontal clearance shall be restored before the flagging operation is removed.

- c. Highway Work Zone: All sections or segments of the roadway under construction or reconstruction shall be signed as a Highway Work Zone except non-state highway two-lane two-way resurfacing projects. Two conditions can be applied to a Highway Work Zone. Condition 1 is when no reduction in the existing speed limit is required. Condition 2 is when worksite conditions require a reduction of the speed limit through the designated Work Zone. Properly marking a Highway Work Zone shall include the following minimum requirements:

- 1. NO REDUCTION IN THE EXISTING POSTED SPEED LIMIT IN HIGHWAY WORK ZONE:

- a) Signage ([Detail 150-HWZ-2](#)) shall be posted at the beginning point of the Highway Work Zone warning the traveling public that increased penalties for speeding violations are in effect. The [HWZ-2](#) sign shall be placed a minimum of six hundred (600') feet in advance of the Highway Work Zone and shall not be placed more than one thousand (1000') feet in advance of the Work Zone. If no speed reduction is required it is recommended that the [HWZ-2](#) be placed at 750 feet from the work area between the ROAD WORK 500 FT. and the ROAD WORK 1000 FT. signs.

[HWZ-2](#) signs shall be placed at intervals not to exceed one mile for the length of the project. [HWZ-2](#) signs should be placed on the mainline after all major intersections except State Routes. State Routes shall be signed as per the requirements for intersecting roadways below.

- b) The existing speed limit shall be posted at the beginning of the Work Zone. Existing Speed Limit signs (R2-1) shall be maintained.
- c) INTERSECTING ROADWAYS: Intersecting state routes shall be signed in advance of each intersection with the Work Zone with a [HWZ-2](#) sign to warn motorists that increased fines are in effect. All other intersecting roadways that enter into a designated Highway Work Zone may be signed in advance of each intersection with the Work Zone. When construction equipment and personnel are present in the intersection on the mainline of a multi-lane roadway, the intersecting side roads shall be signed in advance with [HWZ-2](#) signs. As soon as the work operation clears the intersection the signage may be removed.
- d) Signage ([Detail 150-HWZ-3](#)) shall be posted at the end of the Highway Work Zone indicating the end of the zone and indicating that increased penalties for speeding violations are no longer in effect.

- e) When a designated Highway Work Zone is no longer necessary all signs shall be removed immediately.

2. REDUCING THE SPEED LIMIT IN A HIGHWAY WORK ZONE:

Highway Work Zone signs shall be posted as required in Condition 1 above.

For limited access (interstate) highways and controlled access multi-lane divided highways the posted speed limit shall be reduced as required below.

Speed Limit signage (R2-1) for the reduced speed limit shall be erected at the beginning of the work zone. Additional signs shall be placed to ensure that the maximum spacing of the reduced speed limit signs shall be no greater than one (1) mile apart. Existing speed limit signs shall be covered or removed. On multi-lane divided highways the speed limit signs shall be double indicated when the reduced speed is in use.

When any one or more of the following conditions exist and the existing speed limit is 65 mph or 70 mph, the speed limit shall be reduced by 10 mph. If the existing speed limit is 60 mph, the speed limit should be reduced by 5 mph. If the existing speed limit is 55 mph or less, the Contractor can only reduce the speed limit with the prior approval of the Engineer. The reduction in the speed limit shall be no greater than 10 mph:

- a) Lane closure(s) of any type and any duration.
- b) The difference in elevation exceeds two inches adjacent to a travel lane as shown in [Subsection 150.06](#), [Detail 150-B](#), [150-C](#).
- c) Any areas where equipment or workers are within ten feet of a travel lane.
- d) Temporary portable concrete barriers located less than two (2') feet from the traveled way.
- e) As directed by the Engineer for conditions distinctive to this project.

When the above conditions are not present the speed limit shall be immediately returned to the existing posted speed limit. A speed reduction shall not be put in place for the entire length of the project unless conditions warranting the speed reduction are present for the entire project length. All existing speed limit signs within the temporary speed reduction zone shall be covered or removed while the temporary reduction in the speed limit is in effect. All signs shall be erected to comply with the minimum requirements of the MUTCD.

As a minimum the following records shall be kept by the WTCS:

- a) Identify the need for the reduction.
- b) Record the time of the installation and removal of the temporary reduction.
- c) Fully describe the location and limits of the reduced speed zone.
- d) Document any accident that occurs during the time of the reduction.

A copy of the weekly records for reduced speed zones shall be submitted to the Engineer.

Reduced speed zones shall, as a minimum, be signed as per [Detail 150-HWZ-1](#). Interim signs shall meet the requirements of 150.03 D. Additional signs may be necessary to adjust for actual field conditions.

When a pilot vehicle is used on a two-lane two-way roadway the speed limit should not be reduced. For special conditions specific to the work, on two-lane two-way roadways or multi-lane highways, the contractor may reduce the posted speed limit with the prior approval of the Engineer.

5. MILLED SURFACE RESTRICTIONS:

Unless modified by the special conditions, a milled surface on any asphaltic concrete surface shall not be allowed to remain open to traffic for a period of time that exceeds thirty (30) calendar days.

6. INSTALLATION/REMOVAL OF WORK AREA SIGNAGE:

No payment will be made for Traffic Control-Lump Sum until the Work has actually started on the project. The installation of traffic control signage does not qualify as the start of work. Advanced warning signs shall not be installed until the actual beginning of work activities. Any permanent mount height signs installed as the work is preparing to start shall be covered until all signs are installed unless all signs are installed within seven (7) calendar days after beginning installation.

All temporary traffic control devices shall be removed as soon as practical when these devices are no longer needed. When work is suspended for short periods of time, temporary traffic control devices that are no longer appropriate shall be removed or covered.

All construction warning signs shall be removed within seven (7) calendar days after time charges are stopped or pay items are complete. If traffic control devices are left in place for more than ten (10) calendar days after completion of the Work, the Department shall have the right to remove such devices, claim possession thereof, and deduct the cost of such removal from any monies due, or which may become due, the Contractor.

PUNCHLIST WORK: Portable signs shall be utilized to accomplish the completion of all punchlist items. The portable signs shall be removed daily. All permanent mount height signs shall be removed prior to the beginning of the punchlist work except "Low/Soft Shoulder" signs and any signs that have the prior written approval of the Engineer to remain in place while the punchlist work is in progress.

Failure to promptly remove the construction warning signs within the seven (7) calendar days after the completion of the Work or failure to remove or cover signs when work is suspended for short periods of time shall be considered as non-performance under Section 150.08.

SPEED LIMIT REDUCTION FOR HIGHWAY WORK ZONE
 INTERSTATE AND MULTI-LANE DIVIDED HIGHWAY SIGNING SHALL BE
 DOUBLE INDICATED (RIGHT SHOULDER AND MEDIAN SHOULDER)

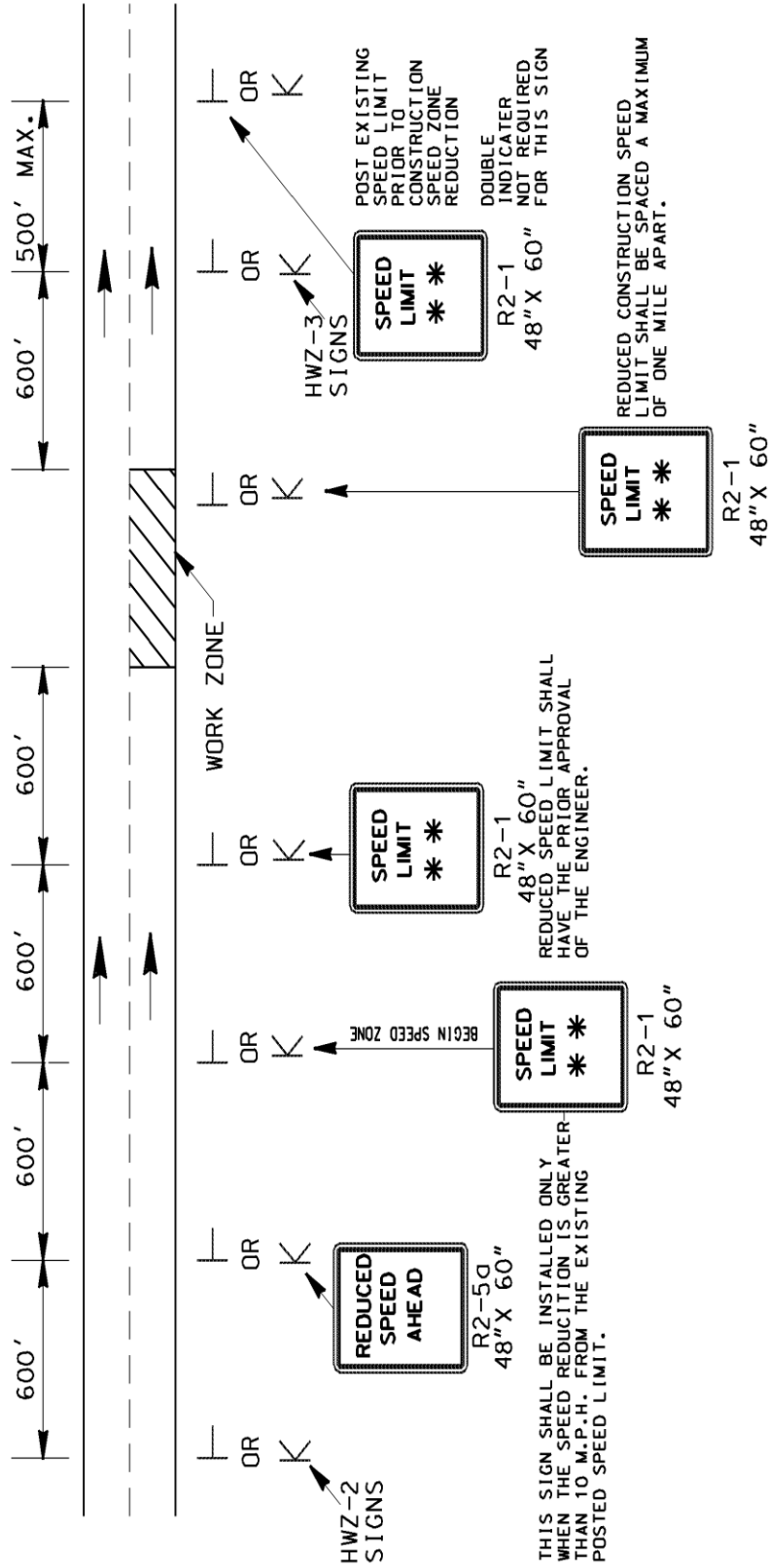

ALL INTERSECTING ROADWAYS SHALL BE SIGNED WITH A HWZ-2 SIGN TO WARN MOTORIST ENTERING THE HIGHWAY WORK ZONE.
 INTERSTATE AND MULTI-LANE HIGHWAY SIGNING SHALL BE DOUBLE INDICATED (RIGHT SHOULDER AND MEDIAN SHOULDER).

SIGN SIZES SHOWN ARE FOR INTERSTATE AND MULTI-LANE DIVIDED HIGHWAY. FOR OTHER HIGHWAYS USE STANDARD SIZE SIGNS AS PER THE M.U.T.C.D. EXCEPT HWZ-2 AND HWZ-3 SIGNS.

DETAIL 150-HWZ-1

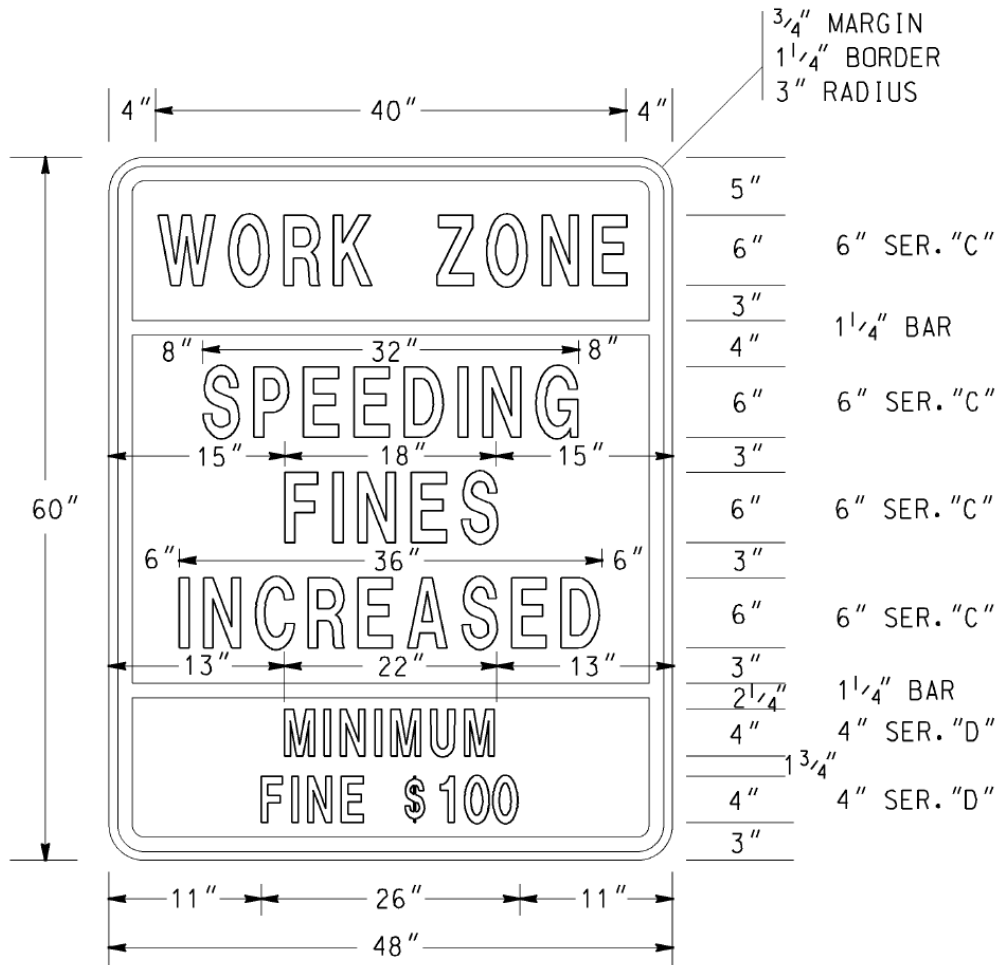

COLORS

TOP PANEL

LEGEND & BORDER - BLACK (NON-REFL)

BACKGROUND - FLUORESENT ORANGE

(ASTM TYPE VII, VIII, IX or X)

MIDDLE & BOTTOM PANELS

LEGEND & BORDER - BLACK (NON-REFL)

BACKGROUND - WHITE (ASTM TYPE III OR IV REFL SHEETING)

NOTES:

1. ALL HWZ-2 SIGN PANELS SHALL BE RIGID.
2. THE SIZE OF THE HWZ-2 SIGN SHALL NOT BE REDUCED FOR USE ON TWO-LANE ROADWAYS.

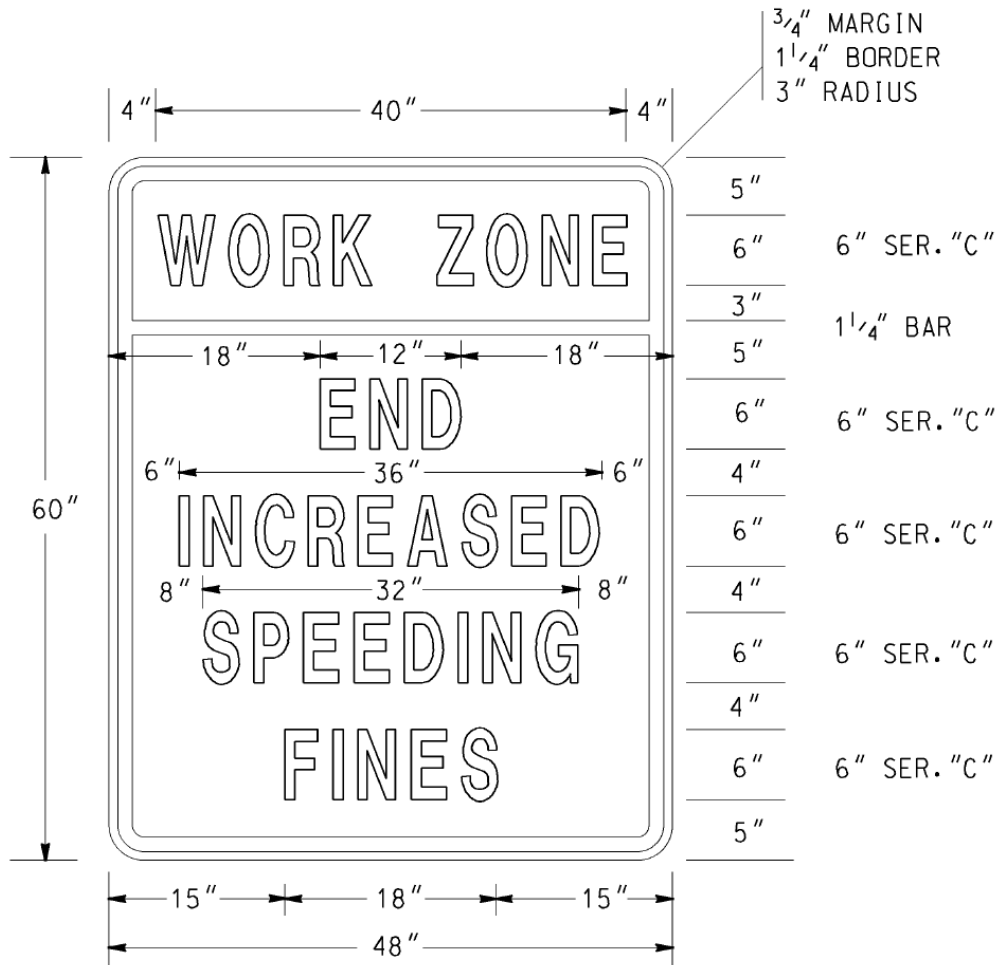

HWZ-3

COLORS

TOP PANEL

LEGEND & BORDER - BLACK (NON-REFL)

BACKGROUND - FLUORESENT ORANGE

(ASTM TYPE VII, VIII, IX or X)

BOTTOM PANEL

LEGEND & BORDER - BLACK (NON-REFL)

BACKGROUND - WHITE (ASTM TYPE III OR IV REFL SHEETING)

NOTES:

1. ALL HWZ-3 SIGN PANELS SHALL BE RIGID.
2. THE SIZE OF THE HWZ-3 SIGN SHALL NOT BE REDUCED FOR USE ON TWO-LANE ROADWAYS.

C. LANE CLOSURES:

1. Approval/Restrictions

All lane closures of any type or duration shall have the prior approval of the Engineer.

- a. The length of a lane closure shall not exceed two (2) miles in length excluding the length of the tapers unless the prior approval of the Engineer has been obtained. The Engineer may extend the length of a lane closure based upon field conditions however the length of a workzone should be held to the minimum length required to accomplish the Work. Lane closures shall not be spaced closer than one mile. The advanced warning signs for the project should not overlap with the advanced warning signs for lane shifts, lane closures, etc.
- b. Lane closures that require same direction traffic to be split around the Work Area will not be approved for roadways with posted speeds of 35 mph or greater, excluding turn lanes.
- c. For Interstate, Limited Access and Multi-lane Divided Highways, a Portable Changeable Message Sign (PCMS) shall be placed one (1) mile in advance of a lane closure with a message denoting the appropriate lane closure one mile ahead. The Portable Changeable Message Sign (PCMS) shall be placed on the outside shoulder in accordance with Detail 150-PCMS. This is in addition to the other traffic control devices required by Standard 9106.

2. Removal Of Lane Closures

To provide the greatest possible convenience to the public in accordance with [Sub-Subsection 107.07](#), the Contractor shall remove all signs, lane closure markings, and devices immediately when lane closure work is completed or temporarily suspended for any length of time or as directed by the Engineer. All portable signs and portable sign mounting devices shall be removed from the roadway to an area which will not allow the sign to be visible and will not allow the sign or sign mounting device to be impacted by traffic.

3. Exit And Entrance Ramps

On multilane highways where traffic has been shifted to the inside lanes, the exit and entrance ramps shall have channelization devices placed on both sides of the ramp. This requirement will apply to any situation where traffic is shifted to contra flows or inside staging lanes to facilitate reconstruction work in the vicinity of exit and entrance ramps. The temporary ramp taper length shall be greater than, or equal to, the existing taper length. Interim EXIT gore signs shall be placed at the ramp divergence. The "EXIT OPEN" sign shown in Figure TA-42 of the MUTCD shall be utilized. For exit ramps, channelization device spacing shall be decreased to 10 feet for 200 feet in advance of the temporary gore, and be decreased to 10 feet for the first 100 feet of the temporary gore.

4. Lane Drop/Lane Closure

The first seven (7) calendar days of any lane closure shall be signed and marked as per Standard 9106 or 9107. However, lane closures that exist for a duration longer than seven (7) calendar days may be signed and marked as per the details in Standard 9121, provided

the prior approval of the Engineer is obtained. The approved lane drop shall utilize only the signs and markings shown for the termination end of the lane drop in Standard 9121. All warning signs in the lane drop sequence shall be used. Drums may be substituted for the Type I Crystal Delineators at the same spacing.

5. Termination Area

The transition to normal or full width highway at the end of a lane closure shall be a maximum of 150 feet.

D. TRAFFIC PACING METHOD:

1. Pacing Of Traffic

With prior approval from the Engineer, traffic may be paced allowing the Contractor up to ten (10) minutes maximum to work in or above all lanes of traffic for the following purposes:

- a. Placing bridge members or other bridge work.
- b. Placing overhead sign structures.
- c. Other work items requiring interruption of traffic.

The Contractor shall provide a uniformed police officer with patrol vehicle and blue flashing light for each direction of pacing. The police officer, Engineer, and flaggers at ramps shall be provided with a radio which will provide continuous contact with the Contractor.

When ready to start the work activity, the police vehicle will act as a pilot vehicle slowing the traffic thereby providing a gap in traffic allowing the Contractor to perform the Work. Any on-ramps between the pace and the work area shall be blocked during pacing of traffic, with a flagger properly dressed and equipped with a Stop/Slow paddle. Each ramp should be opened after the police vehicle has passed.

Pilot vehicles shall travel at a safe pace speed, desirably not less than 20 mph interstate and 10 mph non-interstate. The Contractor shall provide a vehicle to proceed in front of the police vehicle and behind the other traffic in order to inform the Contractor's work force when all vehicles have cleared the area.

Traffic will not be permitted to stop during pacing except in extreme cases as approved by the Engineer.

2. Methods Of Signing For Traffic Pacing

At a point not less than 1,000 feet in advance of the beginning point of the pace, the Contractor shall erect and cover a W-special sign (72 inch x 72 inch) with a Type "B" flashing light, with the legend "TRAFFIC SLOWED AHEAD SHORT DELAY" (See [Detail 150-A](#)). A portable changeable message sign may be used in lieu of the W-special sign. On divided highways this sign shall be double indicated. A worker with a two-way radio shall be posted at the sign, and upon notice that the traffic is to be paced shall turn on the flashing light and reveal the sign. When traffic is not being paced, the flashing light shall be turned off and the sign covered or removed. W-special signs are reflectorized black on orange, Series "C" letter and border of the size specified.

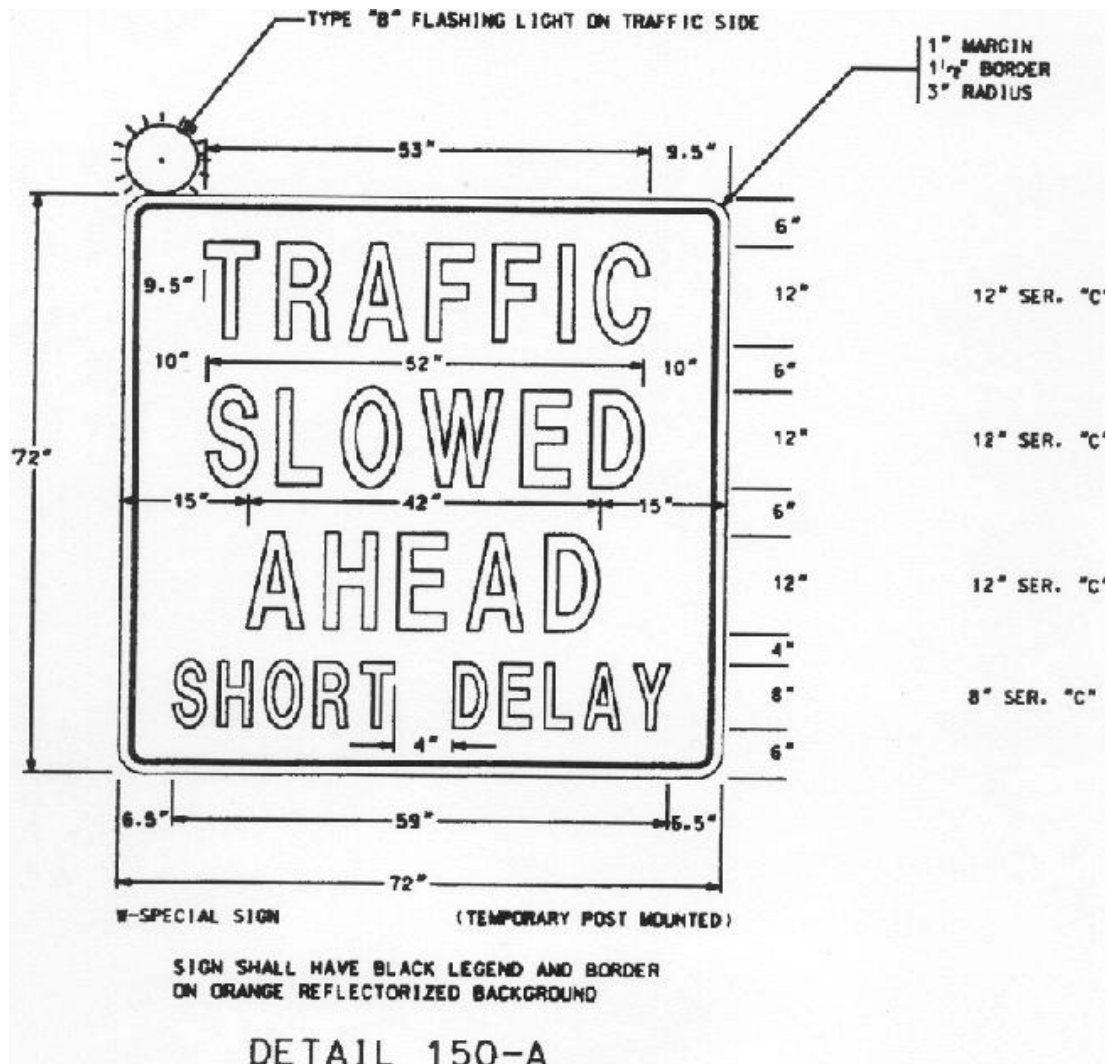

E. CONSTRUCTION VEHICLE TRAFFIC

The Contractor's vehicles shall travel in the direction of normal roadway traffic and shall not reverse direction except at intersections, interchanges, or approved temporary crossings. The Contractor may submit a plan requesting that construction traffic be allowed to travel in the opposite direction of normal traffic when it would be desirable to modify traffic patterns to accommodate specific construction activities.

Prior approval of the Engineer shall be obtained before any construction traffic is allowed to travel in a reverse direction. If the Contractor's submittal is approved the construction traffic shall be separated from normal traffic by appropriate traffic control devices.

F. ENVIRONMENTAL IMPACTS TO THE TEMPORARY TRAFFIC CONTROL (TTC) PLAN

The Contractor shall ensure that dust, mud, and other debris from construction activities do not interfere with normal traffic operations or adjacent properties. All outfall ditches, special ditches, critical storm drain structures, erosion control structures, retention basins, etc. shall be constructed, where possible, prior to the beginning of grading operations so that the best possible drainage and erosion control will be in effect during the grading operations, thereby keeping the roadway areas as dry as possible.

Areas within the limits of the project which are determined by the Engineer to be disturbed or damaged due either directly or indirectly from the progress or the lack of progress of the work shall be cleaned up, redressed, and regrassed. All surplus materials shall be removed and disposed of as required. Surplus materials shall be disposed of in accordance with [Subsection 201.02.E.3](#) of the Specifications.

G. EXISTING STREET LIGHTS

Existing street lighting shall remain lighted as long as practical and until removal is approved by the Engineer.

H. NIGHTWORK

Adequate temporary lighting shall be provided at all nighttime work sites where workers will be immediately adjacent to traffic.

I. CONSTRUCTION VEHICLES IN THE WORKZONE

The parking of Contractor's and/or workers personal vehicles within the work area or adjacent to traffic is prohibited. It shall be the responsibility of the Worksite Traffic Control Supervisor to ensure that any vehicle present at the worksite is necessary for the completion of the work.

J. ENCROACHMENTS ON THE TRAVELED-WAY

The Worksite Traffic Control Supervisor (WTCS) shall monitor the work to ensure that all the rocks, boulders, construction debris, stockpiled materials, equipment, tools and other potential hazards are kept clear of the travelway. These items shall be stored in a location, in so far as practical, where they will not be subject to a vehicle running off the road and striking them.

K. PEDESTRIAN CONSIDERATIONS

All existing pedestrian facilities, including access to transit stops, shall be maintained. Where pedestrian routes are closed, alternate routes shall be provided. Closures of existing, interim and final pedestrian facilities shall have the prior written approval of the Engineer. When existing pedestrian facilities are disrupted, closed or relocated in a TTC zone, the temporary facilities shall be detectable and shall include accessibility features consistent with the features present in the existing pedestrian facility. Pedestrian facilities are considered improvements and provisions made to accommodate or encourage walking. Whenever a sidewalk is to be closed, the Engineer shall notify the maintaining agency two (2) weeks prior to the closure. Prior to closure, detectable barriers (that are detectable by a person with a visual disability traveling with the aid of a long cane), as described by the MUTCD, shall be placed across the full width of the closed sidewalk. Barriers and channelizing devices used along a temporary pedestrian route shall be in compliance with the MUTCD.

Temporary Traffic Control devices used to delineate a Temporary Traffic Control zone pedestrian walkway shall be in compliance with Subsection 150.01.C. Temporary Traffic Control devices and construction material shall not intrude into the usable width of the pedestrian walkway. Signs and other devices shall be placed such that they do not narrow or restrict any pedestrian passage to less than 48 inches.

A pedestrian walkway shall not be severed or relocated for non-construction activities such as parking for construction vehicles and equipment. Movement by construction vehicles and equipment across designated pedestrian walkways should be minimized. When necessary, construction activities shall be controlled by flaggers. Pedestrian walkways shall be kept free of mud, loose gravel or other debris.

When temporary covered walkways are used, they shall be lighted during nighttime hours. When temporary traffic barrier is used to separate pedestrian and vehicular traffic, the temporary barrier shall meet NCHRP-350 Test Level Three. The barrier ends shall be protected in accordance with Georgia Standard 4960. Curbing shall not be used as a substitute for temporary traffic barriers when temporary traffic barriers are required. Tape, rope or plastic chain strung between temporary traffic control devices are not considered as detectable and shall not be used as a control for pedestrian movements.

The WTCS shall inspect the activity area daily to ensure that effective pedestrian TTC is being maintained. The inspection of TTC for pedestrian traffic shall be included as part of the TC-1 report.

1. Temporary Pedestrian Facilities

Temporary pedestrian facilities shall be detectable and include accessibility features consistent with the features present in the existing pedestrian facility. The geometry, alignment and construction of the facility should meet the applicable requirements of the "Americans with Disabilities Act Accessibility Guidelines for Buildings and Facilities (ADAAG)".

a. Temporary Walkways with Detectable Edging

A smooth, continuous hard surface (firm, stable and slip resistant) shall be provided throughout the entire length of the temporary pedestrian facility.

Compacted soils, sand, crushed stone or asphaltic pavement millings shall not be used as a surface course for walkways.

Temporary walkways shall include detectable edging as defined in the MUTCD. When temporary traffic barrier is included as a pay item in the contract and where locations identified on the plans for positive protection will also allow them to serve as pedestrian detectable edging, payment will be made for the temporary traffic barrier in accordance with [Section 620](#). No payment will be made for temporary walkways with Detectable Edging where existing pavements or existing edging (that meets the requirements of MUTCD) are utilized as temporary walkways. Payment for temporary detectable edging, including approved barriers and channelizing devices, installed on existing pavements shall be included in Traffic Control-Lump Sum.

Regardless of the materials used, temporary walkways shall be constructed of sufficient thickness and durability to withstand the intended use for the duration of the construction project. If concrete or asphalt is used as the surface course for the walkway, it shall be a minimum of one and one-half inches (1-1/2") thick. Temporary walkways constructed across unimproved streets and drives shall be a minimum thickness of four inches (4") for concrete and three inches (3") for asphalt. Joints formed in concrete sidewalks shall be in accordance with [Section 441](#). Concrete surfaces shall have a broom finish.

If plywood is used as a walkway, it must be a minimum of three quarters of an inch (3/4") thick pressure treated and supported with pressure treated longitudinal joists spaced a maximum of sixteen inches (16") on center. The plywood shall be secured to the joist with galvanized nails or galvanized deck screws. Nails and screws shall be countersunk to prevent snagging or tripping the pedestrians. A slip resistant friction course shall be applied to any plywood surface that is used as a walkway. Any slip resistant material used shall have the prior written approval of the engineer.

The contractor may propose alternate types of Temporary Walkways provided the contractor can document that the proposed walkway meets the requirements of the "Americans with Disabilities Act Accessibility Guidelines for Buildings and Facilities (ADAAG)". Alternate types of Temporary Walkways shall have the prior written approval of the engineer.

Temporary walkways shall be constructed and maintained so there are no abrupt changes in grade or terrain that could cause a tripping hazard or could be a barrier to wheelchair use. The contractor shall construct and maintain the walkway to ensure that joints in the walkway have a vertical difference in elevation of no more than one quarter (1/4") of an inch and that the horizontal joints have gaps no greater than one half (1/2") of an inch. The grade of the temporary walkway should parallel the grade of the existing walkway or roadway and the cross slope should be no greater than 2%.

A width of sixty (60") inches, if practical, should be provided throughout the entire length of any temporary walkway. The temporary walkway shall be a minimum width of forty eight inches (48"). When it is not possible to maintain a minimum width of sixty inches (60") throughout the entire length of temporary walkway, a

sixty inch (60") by sixty inch (60") passing space should be provided at least every two hundred feet (200 Ft.), to allow individuals in wheelchairs to pass.

Temporary walkways shall be constructed on firm subgrade. Compact the subgrade according to [Section 209](#). Furnish and install any needed temporary pipes prior to constructing any walkway to ensure positive drainage away from or beneath the temporary walkway. Once the walkway is no longer required, remove any temporary materials and restore the area to the original conditions or as shown in the plans.

b. Temporary Curb Cut Wheelchair Ramps

Temporary curb cut wheelchair ramps shall be constructed in accordance with [Section 441](#) and Detail A-3. Ramps shall also include a detectable warning surface in accordance with Detail A-4. Other types of material for the construction of the temporary curb cut wheelchair ramps, including the detectable warning surface, may be used provided the contractor can provide documentation that the material to be used meets the requirements of the "Americans with Disabilities Act Accessibility Guidelines for Buildings and Facilities (ADAAG)". When a wheelchair ramp is no longer required, remove the temporary materials and restore the area to existing conditions or as shown in the plans. For the items required to restore the area to original conditions or as shown in the plans, measures for payment shall be covered by contract pay items. If pay items are not included in the contract, then payment for these items shall be included in Traffic Control-Lump Sum.

c. Temporary Audible Information Device

Temporary audible information devices, when shown in the plans, shall be installed in compliance with the "Americans with Disabilities Act Accessibility Guidelines for Buildings and Facilities (ADAAG)". The devices shall be installed in accordance with the manufacturer's recommendations. Prior to installation, the contractor shall provide the engineer with a set of manufacturer's drawings detailing the proper installation procedures for each device. When no longer required, the devices shall remain the property of the contractor.

L. TRAFFIC SIGNALS

If the sequence of operations, staging, or the temporary traffic control plan requires the relocation or shifting of any components of an existing traffic signal system then any work on these traffic signals will be considered as part of Lump Sum- Traffic Control. The contractor becomes responsible for the maintenance of these traffic signals from the time that the system is modified until final acceptance. The maintenance of traffic signals that are not a part of the work and are not in conflict with any portion of the work shall not be the responsibility of the contractor.

When construction operations necessitate an existing traffic signal to be out of service, the Contractor shall furnish off-duty police officers to regulate and maintain traffic control at the site. Off-duty police officers may also be required to regulate and maintain traffic control at signal sites when lane closures or traffic shifts block or restrict movements

causing interference with normal road user flows and will not allow the activated traffic signal to guide the traffic through the signal site.

M. REMOVAL/REINSTALLATION OF MISCELLANEOUS ITEMS

In the prosecution of the Work, if it becomes necessary to remove any existing signs, markers, guardrail, etc. not covered by specific pay item, they shall be removed, stored and reinstalled, when directed by the Engineer, to line and grade, and in the same condition as when removed.

150.03 SIGNS:

A. SIGNING REQUIREMENTS OF THE TEMPORARY TRAFFIC CONTROL (TTC) PLAN

When existing regulatory, warning or guide signs are required for proper traffic and pedestrian control the Contractor shall maintain these signs in accordance with the temporary traffic control (TTC) plan. The Contractor shall review the status of all existing signs, interim signs added to the work, and permanent sign installations that are part of the work to eliminate any conflicting or non-applicable signage in the TTC Plan. The Contractor's review of all signs in the TTC Plan shall establish compliance with the requirements of the MUTCD and Section 150. Any conflicts shall be reported to the Engineer immediately and the WTCS shall take the necessary measures to eliminate the conflict.

The Contractor shall make every effort to eliminate the use of interim signs as soon as the Work allows for the installation of permanent signs.

All existing illuminated signs shall remain lighted and be maintained by the Contractor.

Existing street name signs shall be maintained at street intersections.

B. CONFLICTING OR NON-APPLICABLE SIGNS

Any sign(s) or portions of a sign(s) that are not applicable to the TTC plan shall be covered so as not to be visible to traffic or shall be removed from the roadway when not in use. The WTCS shall review all traffic shifts and changes in the traffic patterns to ensure that all conflicting signs have been removed. The review shall confirm that the highest priority signs have been installed and that signs of lesser significance are not interfering with the visibility of the high priority signs. High priority signs include signs for road closures, shifts, detours, lane closures and curves. Any signs, such as speed zones and speed limits, passing zones, littering fines and litter pick up, that reference activities that are not applicable due to the presence of the Work shall be removed, stored and reinstalled when the Work is completed.

Failure to promptly eliminate conflicting or non-applicable signs shall be considered as non-performance under [Section 150.08](#).

C. REMOVAL OF EXISTING SIGNS AND SUPPORTS

The Contractor shall not remove any existing signs and supports without prior approval from the Engineer. All existing signs and supports which are to be removed shall be stored and protected if this material will be required later in the work as part of the TTC plan. If the signs are not to be utilized in the work then the signs will become the property of the Contractor unless otherwise specified in the contract documents.

D. INTERIM GUIDE, WARNING AND REGULATORY SIGNS

Interim guide, warning, or regulatory signs required to direct traffic and pedestrians shall be furnished, installed, reused, and maintained by the Contractor in accordance with the MUTCD, the Plans, Special Provisions, Special Conditions, or as directed by the Engineer. These signs shall remain the property of the Contractor. The bottom of all interim signs shall be mounted at least seven (7') feet above the level of the pavement edge when the signs are used for long-term stationary operations as defined by Section 6G.02 of the MUTCD. Special Conditions under Subsection 150.11 may modify this requirement.

Portable signs may be used when the duration of the work is less than three (3) days or as allowed by the special conditions in Subsection 150.11. Portable signs shall be used for all punchlist work. All portable signs and sign mounting devices utilized in work shall be NCHRP 350 compliant. Portable interim signs shall be mounted a minimum of one (1') foot above the level of the pavement edge for directional traffic of two (2) lanes or less and a minimum of seven (7') feet for directional traffic of three (3) or more lanes. Signs shall be mounted at the height recommended by the manufacturer's crashworthy testing requirements. Portable interim signs which are mounted at less than seven (7') feet in height may have two 18 inch x 18 inch fluorescent red-orange or orange-red warning flags mounted on each sign.

All regulatory sign blanks shall be rigid whether the sign is mounted as a portable sign, on a Type III barricade or as a permanent mount height sign.

Any permanent mount height interim sign that is designed to fold in half to cover a non-applicable message on the sign shall have reflectorized material on the folded over portion of the sign. The reflectorized material shall be orange in color with a minimum of ASTM Type I engineering grade sheeting with a minimum area of six inches by six inches (6" x 6") facing the direction of traffic at all times when the sign is folded.

Interim signs may be either English or metric dimensions.

E. EXISTING SPECIAL GUIDE SIGNS

Existing special guide signs on the Project shall be maintained until conditions require a change in location or legend content. When change is required, existing signs shall be modified and continued in use if the required modification can be made within existing sign borders using design requirements (legend, letter size, spacing, border, etc.) equal to that of the existing signs, or of [Sub-Section 150.03.E.2](#). Differing legend designs shall not be mixed in the same sign.

1. Special Guide Signs

Special guide signs are those expressway or freeway guide signs that are designed with a message content (legend) that applies to a particular roadway location. When

an existing special guide sign is in conflict with work to be performed, the Contractor shall remove the conflicting sign and reset it in a new, non-conflicting location which has been approved by the Engineer.

2. Interim Special Guide Signs

When it is not possible to utilize existing signs, either in place or relocated, the Contractor shall furnish, erect, maintain, modify, relocate, and remove new interim special guide signs in accordance with the Plans or as directed by the Engineer. Interim special guide signs that may be required in addition to, or a replacement for, existing expressway and freeway (interstate) signs shall be designed and fabricated in compliance with the minimum requirements for guide signing contained in Part 2E "Guide Signs Expressway" and Part 2F "Guide Signs Freeways" of the MUTCD, except that the minimum size of all letters and numerals in the names and places, streets and highways on all signs shall be 16 inches Series "E" initial upper-case and 12 inches lower-case. All interstate shields on these signs shall be 48 inches and 60 inches for two-numeral and three-numeral routes, respectively.

The road name of the exit or route shield shall be placed on the exit gore sign.

3. Interim Overhead Guide Sign Structures

Interim overhead special guide sign structures are not required to be lighted unless specifically required by the Plans. If lighting is required the sign shall be lighted as soon as erected and shall remain lighted, during the hours of darkness, until the interim sign is no longer required. The Contractor shall notify the Power Company at least thirty (30) days prior to desired connection to the power source.

4. Permanent Special Guide Signs

The installation of new permanent special guide signs and the permanent modification or resetting of existing special guide signs, when included in the contract, shall be accomplished as soon as practical to minimize the use of interim special guide signs. If lighting is required by the Plans, all new permanent overhead special guide signs shall be lighted as soon as erected.

F. MATERIALS- INTERIM SIGNS:

1. Posts

Permanent mounting height of seven (7') feet- Posts for all interim signs shall meet the requirements of Section 911 except that green or silver paint may be used in lieu of galvanization for steel posts or structural shape posts. Within the limits of a single project, all metal posts shall be the same color. Wood posts are not required to be pressure treated.

Interim posts may be either metric or English in dimensions.

Posts for all interim signs shall be constructed to yield upon impact unless the posts are protected by guardrail, portable barrier, impact attenuator or other type of positive barrier protection. Unprotected posts shall meet the breakaway requirements of the "1994 AASHTO Standard Specifications for Structural Support for Highway Signs, Luminaries and Traffic Signals". Unprotected interim posts shall be spliced as shown in [Detail 150-F](#) unless full length unspliced posts are used.

Unprotected post splices will not be permitted any higher than four inches above the ground line to lessen the possibility of affecting the undercarriage of a vehicle. Installation of posts may require establishment of openings in existing pavements, islands, shoulders etc.

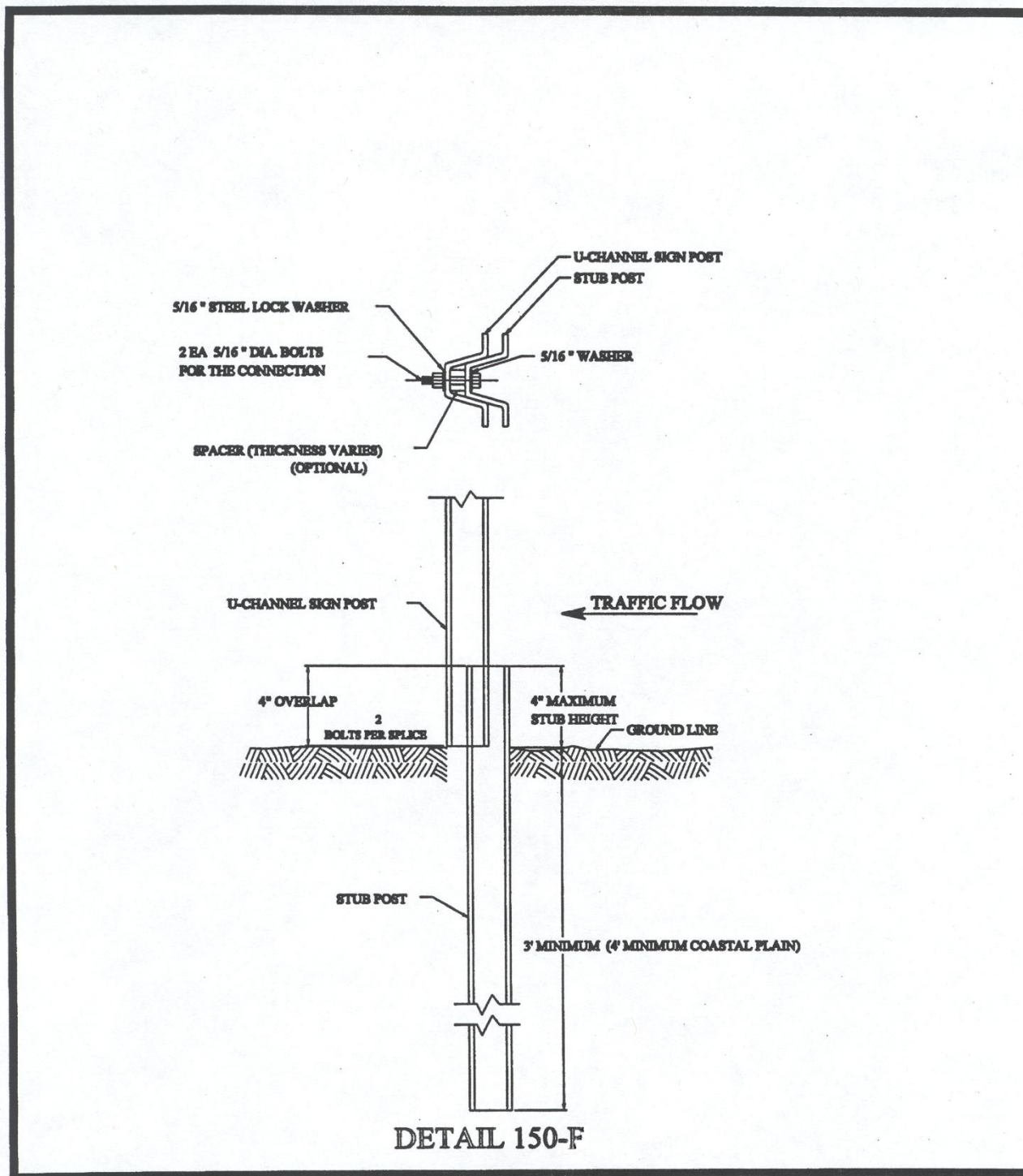

2. Sign Blanks And Panels- Permanent mounting height of seven (7') feet-

All sign blanks and panels shall conform to [Section 912](#) of the Specifications except that blanks and panels may be ferrous based or other metal alloys. Type 1 and Type 2 sign blanks shall have a minimum thickness of 0.08 inches regardless of the sign type used. Alternative sign blank materials (composites, poly carbonates, fiberglass reinforced plastics, recycled plastics, etc.) shall have a letter of approval from the Office of Materials and Research for use as interim construction signs before these materials are allowed to be incorporated into the work unless these rigid sign blanks are currently approved as a crashworthy sign blank material under QPL 34. The back side of sign panels shall be painted orange to prevent rust if other metals are used in lieu of aluminum. Plywood blanks or panels will not be permitted. The use of flexible signs will not be permitted for permanent mount height signs.

Interim blanks and panels may be either metric or English in dimensions.

3. Portable Sign Mounting Devices, Portable Sign Blanks-

All portable sign mounting devices and sign blanks utilized in the work shall be NCHRP 350 Test Level III compliant. All portable sign mounting devices and sign blanks shall be from the Qualified Products List. Any sign or sign mounting device shall have an identifying decal, logo, or manufacturer's stamping that clearly identifies the device as NCHRP 350 compliant. The required decal, logo or manufacturer's stamping shall not be displayed on the message face of the sign. The Contractor may be required to provide certification from the Manufacturer as proof of NCHRP 350 compliance. All portable signs shall be mounted according to height requirements of [Subsection 150.03.D](#).

G. SIGN VISIBILITY AND OFFSETS

All existing, interim and new permanent signs shall be installed so as to be completely visible for an advance distance in compliance with the MUTCD. Any clearing required for maintaining the line of sight to existing, interim or permanent signs shall be done as part of the requirements of the TTC plan. The clearing shall include any advance warning signs, both interim and permanent, that are installed as a part of the work including advance warning signs that are installed outside the limits of the project. Any sign installed behind W-beam or T-beam guardrail with non-breakaway posts shall be installed with the leading edge of the sign a minimum of four feet and three inches (4'3") behind the face of the guardrail with five feet (5') of clearance being desirable. Limbs, brush, construction equipment and materials shall be kept clear of the driver's line of sight to all signs that are part of the TTC plan.

H. ADVANCE WARNING SIGNS:

1. All Type Of Highways

Advance warning signs shall be placed ahead of the work area in accordance with Part VI of the MUTCD and shall include a series of at least three advance road work (W20-1) signs placed at the termini of the project. The series shall have the legend ROAD WORK (1500 FEET, 1000 FEET, AND 500 FEET).

At grade intersecting roadways and on-ramps shall be signed with a minimum of one ROAD WORK AHEAD sign.

When work terminates at a "T" intersection, a minimum of one "ROAD WORK AHEAD" sign shall be placed in advance of the intersection and one "END ROAD WORK" sign shall be placed at the termination end of the intersection. Field conditions may require the use of additional warning signage.

Advanced Warning Signs on State Routes shall be a minimum dimension of 48 inches x 48 inches. When a State Route intersects a project which consists of adding travel lanes, reconstructing an existing roadway or new location work, the State Route approaches shall have a minimum of three (W20-1) advanced warning signs (1500 ft., 1000 ft., 500 ft.). The termination end of an intersecting State Route shall have END ROAD WORK signage.

The W20-1 signs shall be placed at the termini of the project or sufficiently in advance of the termini to allow for lane shifts, lane closures and other activities which may also require advanced warning signs. The advanced warning signs for the project should not overlap with the advanced warning signs for lane shifts, lane closures, etc.

The length of a workzone should be held to the minimum length required to accomplish the work. If a project has multiple individual worksites within the overall limits of the project, each site should be signed individually if the advance warning signs for each site can be installed without overlapping an adjacent worksite. As soon as the work is completed at any individual site the warning signs shall be removed from that site. Clean-up work and punchlist work shall be performed with portable signage.

Project mileage indicated on the G20-1 sign shall be the actual project mileage rounded up to the nearest whole mile. Projects less than two (2) miles in length or individual worksites that are part of a multiple worksite project may delete this sign. The G20-1 sign shall be 60" X 36" and the G20-2 sign shall be 48" X 24".

2. Interstate, Limited Access And Multilane Divided Highways

In addition to the W20-1 signs required at 500 ft., 1000 ft. and 1500 ft., multi-lane divided highways shall also have additional advanced warning signs installed with the legend "ROAD WORK (2 MILES, 1 MILE and 1/2 MILE). All construction warning signs on divided highways shall be double indicated (i.e., on the left and right sides of the roadway.) If the use of the 1/2 mile, 1 mile and 2 mile advanced warning signs cause an overlap with other work or do not benefit field conditions then the Engineer may review the use of these signs and eliminate their installation. When the posted speed limit is 50 MPH or less, the 1/2 mile, 1 mile and 2 mile signs should be eliminated especially in urban areas.

The W20-1 advance warning signs for ROAD WORK 500 FEET; 1000 FEET; and 1500 FEET shall be temporarily covered when work involving the advanced warning signs for lane shifts and lane closures overlap these signs. The ROAD WORK 1/2 MILE, ROAD WORK 1 MILE, and ROAD WORK 2 MILES shall be in place when the 500, 1000 and 1500 feet signs are temporarily covered.

When the temporary traffic control zone already has advanced warning (W20-1) signs installed the W20-1 signs required for lane closures under Standard 9106 should be eliminated.

RAMP WORK ON LIMITED ACCESS HIGHWAYS: The workzone shall not be signed for the entire length of the mainline of a limited access highway when only short individual worksites, interchange or ramp work is being performed.

When work is restricted to ramp reconstruction or widening activities, the advance warning signs on the mainline section of the limited access highway shall be limited to the use of portable advance warning signs. These portable advance warning signs shall only be utilized when work activity is within the gore point of the ramp and the mainline traveled way or work is active in the accel/decel lane adjacent to the mainline traveled way. Portable advance warning signs (W20-1; 1500ft. /1000 ft. /500ft.) shall be installed on the traveled way of the limited access highway when the above conditions are present. The advance warning signs shall be installed only in one direction where work is active. All portable signs shall be double indicated. When work is not active, the ramp work shall be advanced warned by the use of a single 48 inch X 48 inch "RAMP WORK AHEAD" sign along the right shoulder of the mainline traveled way prior to the beginning of the taper for the decel lane. The "RAMP WORK AHEAD" sign shall be mounted at seven (7') feet in height. Differences in elevation shall be in compliance with the requirements of [Subsection 150.06](#) prior to the removal of the portable (W20-1) advanced warning signs from the mainline.

The G20-1 sign shall be eliminated on limited access highways when the work involves only ramp work, bridge reconstruction, bridge painting, bridge joint repairs, guardrail and anchor replacement or other site specific work which is confined to a short section of limited access highway.

I. PORTABLE CHANGEABLE MESSAGE SIGN

Unless specified as a paid item in the contract the use of a portable changeable message sign will not be required. When specified, a portable changeable message sign (PCMS) shall meet the minimum requirements of [Section 632](#) and the MUTCD. The maximum amount of messages allowed to be flashed on one PCMS is two phases (flashes). The language and the timing of the messages shall comply with the MUTCD and Section 632. When used as an advanced device the PCMS should typically be placed ahead of the construction activities. If the PCMS is used as a substitute for another device then the requirements for the other device apply.

J. FLASHING BEACON

The flashing beacon assembly, when specified, shall be used in conjunction with construction warning signs, regulatory, or guide signs to inform traffic of special road conditions which require additional driver attention. The flashing beacon assembly shall be installed in accordance with the requirements of [Section 647](#).

K. RUMBLE STRIP SIGNAGE

Signage for rumble strips located in the travelway shall be as required in [Subsection 150.01.C](#) and [Subsection 150.02.A.9](#).

L. LOW/SOFT SHOULDER SIGNAGE

Low or soft shoulder signs shall be utilized in accordance with the following conditions:

CONSTRUCTION/RECONSTRUCTION PROJECTS:

"LOW/SOFT SHOULDER" signs shall be erected when a difference in elevation exceeds one (1") inch but does not exceed three (3") inches between the travelway and any type of shoulder unless the difference in elevation is four (4') feet or greater from the edge of the traveled way.

The spacing of the signs shall not exceed one (1) mile and the signs shall be placed immediately past each crossroad intersection. The "Low/Soft" signs shall remain in place until the difference in elevation is eliminated and the shoulder has been dressed and permanently grassed for a minimum of thirty (30) calendar days. These signs shall be furnished, installed, maintained and removed by the Contractor as part of Traffic Control- Lump Sum. These signs shall be orange with black borders and meet the reflectorization requirements of [Subsection 150.01.C](#).

"SHOULDER DROP-OFF" (W8-9a) signs shall be used when a difference in elevation, less than four (4') feet from the traveled way, exceeds three (3") inches and is not protected by positive barrier protection. These warning signs shall be placed in advance of the drop-off. For a continuous drop-off condition, the W8-9a) signs shall, as a minimum, be spaced in accordance with the above requirements for "Low/soft shoulder" signs.

PROJECTS CONSISTING PRIMARILY OF ASPHALTIC CONCRETE RESURFACING ITEMS:

"LOW/SOFT SHOULDER" signs shall be erected when a difference in elevation exceeds one (1") inch but does not exceed three (3") inches between the travelway and any type of shoulder unless the difference in elevation is four (4') feet or greater from the edge of the traveled way.

SHOULDER BUILDING INCLUDED IN THE CONTRACT: "Low/Soft Shoulder" signs shall be erected as per the requirement of Standards 9102, 9106, and 9107. "Shoulder Drop-off" signs (W8-9a) shall be erected as per the requirements of the MUTCD. These signs shall be maintained until the conditions requiring their installation have been eliminated. The Contractor shall remove all interim warning signs before final acceptance.

SHOULDER BUILDING NOT INCLUDED IN THE CONTRACT: The Department will furnish the "Low/Soft Shoulder" signs, "Shoulder Drop-off" signs and the posts. The signs shall be erected to meet the minimum requirements of [Subsection 150.03](#). The Contractor shall include the cost of furnishing installation hardware (bolts, nuts, and washers), erection and maintenance of the signs in the bid price for Traffic Control- Lump Sum. The Contractor shall maintain the signs until final acceptance. The Department will remove the signs.

LAU/LAR PROJECTS SHOULDER BUILDING NOT INCLUDED IN THE CONTRACT: The Contractor will furnish, install and maintain LOW/SOFT SHOULDER signs (yellow with black borders, ASTM Type III or IV) at the appropriate spacing, until Final Acceptance of the project by the Department. After Final Acceptance by the Department the signs will become the property and responsibility of the local government.

M. BUMP SIGNAGE:

MULTI-LANE DIVIDED HIGHWAYS: A bump sign (W8-1) shall be utilized when a transverse joint in the pavement structure has a vertical difference in elevation of three quarters

(3/4") of an inch or greater in depth with no horizontal taper to ramp the traffic from one elevation to the other. This condition typically occurs at approach slabs during pavement milling operations and at transverse joints in asphaltic pavement lifts.

TWO-LANE TWO-WAY HIGHWAYS: A bump sign (W8-1) shall be utilized when a transverse joint in the pavement structure has a vertical difference in elevation that exceeds one and three quarters (1-3/4") inches in depth with no horizontal taper to ramp the traffic from one elevation to the other. This includes utility and storm drainage repairs that require concrete placement for patching and/or steel plating.

The (W8-1) sign shall be placed sufficiently in advance to warn the motorist of the condition.

N. PEDESTRIAN SIGNAGE:

Appropriate signs as described in the MUTCD shall be maintained to allow safe passage of pedestrian traffic or to advise pedestrians of walkway closures (Refer to MUTCD Figures TA-28 and TA-29 for guidance). Advance closure signing should be placed at intersections rather than midblock locations so that pedestrians are not confronted with midblock work sites that will induce them to attempt skirting the work site or making a midblock crossing. Signs and other devices mounted lower than seven (7) feet above the temporary pedestrian walkway shall not project more than four (4) inches into the accessible pedestrian facilities. Signs and other devices shall be placed such that they do not narrow any pedestrian passage to less than 48 inches.

150.04 PAVEMENT MARKINGS

A. GENERAL

Full pattern pavement markings in accordance with [Section 652](#) and in conformance with Section 3A and 3B, except 3B.02, of the MUTCD are required on all courses before the roadway is opened to traffic. No passing zones shall be marked to conform to [Subsection 150.04.E](#). During construction and maintenance activities on all highways open to traffic, both existing markings and markings applied under this Section shall be fully maintained until Final Acceptance. If the pavement markings are, or become, unsatisfactory in the judgement of the Engineer due to wear, weathering, or construction activities, they shall be restored immediately.

1. Resurfacing Projects

Pavement markings shall be provided on all surfaces that are placed over existing markings. Interim and final markings shall conform in type and location to the markings that existed prior to resurfacing unless changes or additions are noted in the Contract. The replacement of parking spaces will not be required unless a specific item or note has been included in the Contract. Any work to make additions to the markings that existed prior to resurfacing is to be considered as extra work.

2. Widening And Reconstruction Projects

If the lane configuration is altered from the preconstruction layout then pavement markings will be as required by the plans or the Engineer.

3. New Location Construction Projects

Pavement marking plans will be provided.

B. MATERIALS

All traffic striping applied under this Section shall be a minimum four inches in width or as shown in plans and shall conform to the requirements of [Section 652](#), except as modified herein. Raised pavement markers (RPMs) shall meet the requirements of [Section 654](#). Markings on the final surface course, which must be removed, shall be a removable type. The Contractor will be permitted to use paint, thermoplastic, or tape on pavement which is to be overlaid as part of the project, unless otherwise directed by the Engineer. Partial (skip) reflectorization (i.e. reflectorizing only a portion of a stripe) will not be allowed.

C. INSTALLATION AND REMOVAL OF PAVEMENT MARKINGS:

INSTALLATION: All pavement markings, both interim and permanent, shall be applied to a clean surface. The Contractor shall furnish the layout and preline the roadway surface for the placement of pavement markings applied as part of the temporary traffic control plan. All interim marking tape and RPM's on the final surface shall be removed prior to the placement of the final markings.

The Contractor shall sequence the work in such a manner as to allow the installation of markings in the final lane configuration at the earliest possible stage of the work.

REMOVAL: Markings no longer applicable shall be removed in accordance with [Subsection 656.2](#).

THE ELIMINATION OF CONFLICTING PAVEMENT MARKINGS BY OVERPAINTING WITH UNAPPROVED PAINT OR ANY TYPE OF LIQUID ASPHALT IS NOT ACCEPTABLE.

INTERMEDIATE SURFACE: Interim markings shall be removed by methods that will cause minimal damage to the pavement surface while also ensuring that traveling public will not be confused or misdirected by any residual markings remaining on the intermediate surface. The use of approved black-out tape and black-out paint (manufactured for the sole purpose of covering existing pavement markings) may be permitted on some interim surfaces, provided the results are satisfactory to the Engineer.

FINAL SURFACE: No interim paint or thermoplastic markings will be permitted on any final surface unless the interim markings are in alignment with the location of the permanent markings and the interim marking will not interfere or adversely affect placement of the permanent markings. The proposed method of removal for layout errors that require markings to be removed from the final surface shall have the prior approval of the Engineer. Any damage to the final pavement surface caused by the pavement marking removal process shall be repaired at the Contractor's expense by methods acceptable and approved by the Engineer. [Subsection 400.3.06.C](#) shall apply when corrective measures are

required. The use of black-out tape or black-out paint will not be permitted under any circumstance to correct layout errors on any final surface.

Traffic shifts that are done on the final surface shall be accomplished using interim traffic marking tape that can be removed without any blemishing of the final surface. Interim traffic marking tape shall be used on any of the following final surfaces; asphaltic concrete, Portland cement concrete, and bridge deck surfaces. The contractor may propose alternate traffic markings and removal methods on the final surface. Submitted proposals shall include the type of material, method of removal and a cost comparison to the traffic marking tape method. Prior to any approval, the contractor shall field demonstrate to the satisfaction of the Engineer that the proposed traffic markings can be removed without any blemishing of the final surface. If the proposal is determined to be acceptable, a supplemental agreement will be executed prior to the installation of the proposed alternate traffic markings. The supplemental agreement shall denote the type of traffic marking materials, method of removal and any cost and/or time savings to the Department. The Department will not consider or participate in any cost increase that may result from implementing the proposed alternate method.

PAY FACTOR REDUCTION FOR ASPHALTIC CONCRETE FINAL SURFACES: When the correction of an error in the layout of the final pavement markings requires the final surface to be grounded, blemished, scarred, or polished the pay factor shall be reduced to 0.95 for the entire surface area of the final topping that has a blemish, polished or a scarred surface. The reduced pay factor shall not be confined to only the width and length of the stripe or the dimensions of the blemished areas, the whole roadway surface shall have the reduced pay factor applied. The area of the reduced pay factor shall be determined by the total length and the total width of the roadway affected. If the affected area is not corrected, the reduction in pay shall be deducted from the final payment for the topping layer of asphaltic concrete. The Engineer shall make the final determination whether correction or a reduced pay factor is acceptable.

The eradication of pavement markings on intermediate and final concrete surfaces shall be accomplished by a method that does not grind, polish, or blemish the surface of the concrete. The method used for the removal of the interim markings shall not spall chip the joints in the concrete and shall not damage the sealant in the joints. Any joint or sealant repairs shall be included in the bid price for Traffic Control-Lump Sum. The proposed method of removal shall have the prior approval of the Engineer.

Failure to promptly remove conflicting or non-applicable pavement markings shall be considered as non-performance under [Subsection 150.08](#).

PREPARATION AND PLANNING FOR TRAFFIC SHIFTS: When shifting of traffic necessitates removal of centerline, lane lines, or edge lines, all such lines shall be removed prior to, during, or immediately after any change so as to present the least interference with traffic. Interim traffic marking tape shall be used as a temporary substitute for the traffic markings being removed.

Before any change in traffic lane(s) alignment, marking removal equipment shall be present on the project for immediate use. If marking removal equipment failures occur, the equipment shall be repaired or replaced (including leasing equipment if necessary), so that the removal can be accomplished without delay.

Except for the final surface, markings on asphaltic concrete may be obliterated by an overlay course, when approved by the Engineer. When an asphaltic concrete overlay is placed for the sole purpose of eliminating conflicting markings and the in place asphaltic concrete section will allow, said overlay will be eligible for payment only if designated in the Plans. Overlays to obliterate lines will be paid for only once and further traffic shifts in the same area shall be accomplished with removable markings. Only the minimum asphaltic concrete thickness required to cover lines will be allowed. Excessive build-up will not be permitted. When an overlay for the sole purpose of eliminating conflicting markings is not allowed, the markings no longer applicable shall be removed in accordance with [Subsection 656.2](#).

D. RAISED PAVEMENT MARKERS

Raised pavement markers (RPMs) are required as listed below for all asphaltic concrete pavements before the roadway is open to traffic. On the final surface, RPM's shall be placed according to the timeframes specified in 150.04 E. for full pattern pavement markings except Interstate Highways where RPM's shall be placed and/or maintained when the roadway is open to traffic. When Portland Cement Concrete is an intermediate or final surface and is open to traffic, one calendar day is allowed for cleaning and drying before the installation of RPMs is required.

Raised pavement markers are not allowed on the right edge lines under any situation.

1. Interstate Highways

Retro-reflective raised pavement markers (RPM's) shall be placed and/or maintained on intermediate pavements surfaces on all interstate highways that are open to traffic. This includes all resurfacing projects along with widening and reconstruction projects. The spacing and placement shall be as required for MULTI-LANE DIVIDED HIGHWAYS.

2. Multi-Lane Divided Highways

Retro-reflective raised pavement markers (RPMs) shall be placed and/or maintained on intermediate pavement surfaces on all multi-lane divided highways that are opened to traffic when these roadways are being widened or reconstructed. Two lane-two way roadways that are being widened to a multi-lane facility, whether divided or undivided, are included in this provision. Projects consisting primarily of asphalt resurfacing items or shoulder widening items are excluded from this requirement. The RPMs shall be placed as follows:

a. SUPPLEMENTING LANE LINES

80 foot center on skip lines with curvature less than three degrees. (Includes tangents)

40 foot centers on solid lines and all lines with curvature between three degrees and six degrees.

20 foot centers on curves over six degrees.

20 foot centers on lane transitions or shifts.

- b. SUPPLEMENTING RAMP GORE LINES
20 foot centers, two each, placed side by side.

- c. OTHER LINES
As shown on the plans or directed by the Engineer.

3. Other Highways

On other highways under construction RPMs shall be used and/or maintained on intermediate pavement surfaces as follows:

- a. SUPPLEMENTING LANE LINES AND SOLID LINES
40 foot centers except on lane shifts. (When required in the Plans or Contract.)
20 foot centers on lane shifts. (Required in all cases.)
- b. SUPPLEMENTING DOUBLE SOLID LINES
40 foot centers (one each beside each line) except on lane shifts. (When required in the Plans or Contract.)
20 foot centers on lane shifts. (Required in all cases.)

E. EXCEPTIONS FOR INTERIM MARKINGS

Some exceptions to the time of placement and pattern of markings are permitted as noted below; however, full pattern pavement markings are required for the completed project.

1. Two-Lane, Two-Way Roadways

- a. SKIP LINES
All interim skip (broken) stripe shall conform to [Section 652](#) except that stripes shall be at least two feet long with a maximum gap of 38 feet. On curves greater than six degrees, a one-foot stripe with a maximum gap of 19 feet shall be used. In lane shift areas solid lines will be required. Interim skip lines shall be replaced with markings in full compliance with [Section 652](#) prior to expiration of the 14 calendar day period.

Interim raised pavement markers may be substituted for the interim skip (broken) stripes. If raised pavement markers are substituted for the two foot interim skip stripe, three markers spaced at equal intervals over a two foot distance will be required. No separate payment will be made if the interim raised pavement markers are substituted for interim skip lines.

Interim raised pavement markers shall be retro-reflective, shall be the same color as the pavement markers for which they are substituted, and shall be visible during daytime.

The type of interim marker and method of attachment to the pavement shall be approved by the Office of Materials and Research but in no case will the markers be attached by the use of nails. Flexible reflective markers, Type 14 or Type 15, may be used for a maximum of fourteen (14) calendar days as an interim marker. Any flexible reflective markers in use shall be from the qualified products list (QPL).

The interim raised pavement markers shall be maintained until the full pattern pavement markings are applied. At the time full pattern markings are applied the interim raised markers shall be removed in a manner that will not interfere with application of the full pattern pavement markings.

b. NO PASSING ZONES-TWO-LANE, TWO-WAY ROADWAYS

Passing zones shall be re-established in the locations existing prior to resurfacing. No changes to the location of passing zones shall be done without the written approval of the Engineer. For periods not to exceed three calendar days where interim skip centerlines are in place, no-passing zones shall be identified by using post or portable mounted DO NOT PASS regulatory signs (R4-1 24" x 30") at the beginning and at intervals not to exceed ½ mile within each no-passing zone. A post or portable mounted PASS WITH CARE regulatory sign (R4-1 24" x 30") shall be placed at the end of each no-passing zone. Post mounted signs shall be placed in accordance with the MUTCD. Portable signs shall conform to the requirements of the MUTCD and shall be NCHRP 350 compliant. Portable signs shall be secured in such a manner to prevent misalignment and minimize the possibility of being blown over by weather conditions or traffic.

On new location projects and on projects where either horizontal or vertical alignments has been modified, the location of No-Passing Zones will be identified by the Engineer.

c. EDGELINES

1) Bituminous Surface Treatment Paving

Edgelines will not be required on intermediate surfaces (including asphaltic concrete leveling for bituminous surface treatment paving) that are in use for a period of less than 60 calendar days except at bridge approaches, on lane transitions, lane shifts, and in such other areas as determined by the Engineer. On the final surface, edgelines shall be placed within 30 calendar days of the time that the final surface was placed.

2) All Other Types of Pavement

Edgelines will not be required on intermediate surfaces that are in use for a period of less than 30 calendar days except at bridge approaches, on lane transitions, lane shifts, and in such other areas as determined by the Engineer. On the final surface, edgelines shall be placed within 14 calendar days of the time that the surface was placed.

2. Multi-Lane Highways – With No Paved Shoulder(S) Or Paved Shoulder(S) Four Feet Or Less

a. UNDIVIDED HIGHWAYS (INCLUDES PAVED CENTER TURN LANE)

- 1) Centerlines and No-Passing Barrier-Full Pattern centerlines and no-passing barriers shall be restored before opening to traffic.
- 2) Lanelines- Interim skip (broken) stripe as described in [Subsection 150.04E.1.a.](#) may be used for periods not to exceed three calendar days. Skiplines are not permitted in lane shift areas. Solid lines shall be used.
- 3) Edgelines- Edgelines shall be placed on intermediate and final surfaces within three calendar days of obliteration.

b. DIVIDED HIGHWAYS (GRASS OR RAISED MEDIAN)

- 1) Lanelines- Full pattern skip stripe shall be restored before opening to traffic. Skip lines are not permitted in lane shift areas. Solid lines shall be required.
- 2) Centerline/Edgeline- Solid lines shall be placed on intermediate and final surfaces within three calendar days of obliteration.

3. Limited Access Roadways And Roadways With Paved Shoulders Greater Than Four Feet

a. Same as [Subsection 150.04.E.2](#) except as noted in (b) below.

b. EDGELINES-

- 1) Asphaltic Concrete Pavement- Edgelines shall be placed on intermediate and final surfaces prior to opening to traffic.
- 2) Portland Cement Concrete Pavement- Edgelines shall be placed on any surface open to traffic no later than one calendar day after work is completed on a section of roadway. All water and residue shall be removed prior to daily striping.

4. Ramps For Multi-Lane Divided Highways

A minimum of one solid line edge stripe shall be placed on any intermediate surface of a ramp prior to opening the ramp to traffic. The other edge stripe may be omitted for a maximum period of three (3) calendar days on an intermediate surface. Appropriate channelization devices shall be spaced at a maximum of twenty-five (25') feet intervals until the other stripe has been installed.

The final surface shall have both stripes placed prior to opening the ramp to traffic.

5. MISCELLANEOUS PAVEMENT MARKINGS:

FINAL SURFACE: School zones, railroads, stop bars, symbols, words and other similar markings shall be placed on final surfaces conforming to [Section 652](#) within fourteen (14) calendar days of completion of the final surface. Final markings shall conform to the type of pay item in the plans. When no pay item exists in the plans the final markings shall conform to Section 652 for painted markings.

INTERMEDIATE SURFACE: Intermediate surfaces that will be in use for more than forty-five (45) calendar days shall have the miscellaneous pavement markings installed to conform to the requirement of [Section 652](#). Under Subsection 150.11, Special Conditions, or as directed by the Engineer these markings may be eliminated.

F. MOBILE OPERATIONS

When pavement markings (centerlines, lane lines, and edgelines) are applied in a continuous operation by moving vehicles and equipment, the following minimum equipment and warning devices shall be required. These devices and equipment are in addition to the minimum requirements of the MUTCD.

1. All Roadways

All vehicles shall be equipped with the official slow moving vehicle symbol sign. All vehicles shall have a minimum of two flashing or rotating beacons visible in all directions. All protection vehicles shall have an arrow panel mounted on the rear. All vehicles requiring an arrow panel shall have, as a minimum, a Type B panel. All vehicle mounted signs shall be mounted with the bottom of the sign a minimum height of forty-eight inches (48") above the pavement. All sign legends shall be covered or removed from view when work is not in progress.

2. Two-Lane Two-Way Roadways

a. Lead Vehicles

The lead vehicle may be a separate vehicle or the work vehicle applying the pavement markings may be used as the lead vehicle. The lead vehicle shall have an arrow panel mounted so that the panel is easily visible to oncoming (approaching) traffic. The arrow panel should typically operate in the caution mode.

b. Work Vehicles

The work vehicle(s) applying markings shall have an arrow panel mounted on the rear. The arrow panel should typically operate in the caution mode. The work vehicle placing cones shall follow directly behind the work vehicle applying the markings.

c. Protection Vehicles

A protection vehicle may follow the cone work vehicle when the cones are being placed and may follow when the cones are being removed.

3. MULTI-LANE ROADWAYS

A lead vehicle may be used but is not required. The work vehicle placing cones shall follow directly behind the work vehicle applying the markings. A protection vehicle that does not function as a work vehicle should follow the cone work vehicle when traffic cones are being placed. A protection vehicle should follow the cone work vehicle when the cones are being removed from the roadway. Protection vehicles shall display a sign on the rear of the vehicle with the legend PASS ON LEFT (RIGHT).

INTERSTATES AND LIMITED ACCESS ROADWAYS: A protection vehicle shall follow the last work vehicle at all times and shall be equipped with a truck mounted attenuator

that is certified for impacts not less than 62 mph in accordance with NCHRP350 Test Level Three (3).

150.05 CHANNELIZATION

A. GENERAL

Channelization shall clearly delineate the travelway through the work zone and alert drivers and pedestrians to conditions created by work activities in or near the travelway. Channelization shall be done in accordance with the plans and specifications, the MUTCD, and the following requirements.

All Channelization Devices utilized on any project shall be NCHRP 350 compliant. Any device used on the Work shall be from the Qualified Products List. All devices utilized on the work shall have a decal, logo, or manufacturer's stamping that clearly identifies the device as NCHRP 350 compliant. The Contractor may be required to furnish certification from the Manufacturer for any device to prove NCHRP 350 compliance.

1. Types of Devices Permitted for Channelization in Construction Work Zones:

a. DRUMS:

- 1) **DESIGN:** Drums shall meet the minimum requirement of the MUTCD and shall be reflectorized as required in [Subsection 150.01.C](#). The upper edge of the top reflectorized stripe on the drum shall be located a minimum of 33 inches above the surface of the roadway. A minimum drum diameter of 18 inches shall be maintained for a minimum of 34 inches above the roadway.
- 2) **APPLICATION:** Drums shall be used as the required channelizing device to delineate the full length of a lane closure, shift, or encroachment, except as modified by this Subsection.
- 3) **TRANSITION TAPERS FOR LANE CLOSURES:** Drums shall be used on all transition tapers. The minimum length for a merging taper for a lane closure on the travelway shall be as shown in Table 150-1:

TABLE 150-1

Posted Speed Limit, MPH	Lane Width 9 Feet	Lane Width 10 Feet	Lane Width 11 Feet	Lane Width 12 Feet	Maximum Drum Spacing in Tapers, (Feet)
Minimum Taper Length (L) in Feet					
20	60	70	75	80	20
25	95	105	115	125	25
30	135	150	165	180	30
35	185	205	225	245	35
40	240	270	295	320	40
45	405	450	495	540	45
50	450	500	550	600	50
55	495	550	605	660	55
60	540	600	660	720	60
65	585	650	715	780	65
70	630	700	770	840	70
75	675	750	825	900	75

If site conditions require a longer taper then the taper shall be lengthened to fit particular individual situations.

The length of shifting tapers should be at least $\frac{1}{2}$ L.

The length of a closed lane or lanes, excluding the transition taper(s), shall be limited to a total of two (2) miles. Prior approval must be obtained from the Engineer before this length can be increased.

Night time conditions: When a merge taper exists into the night all drums located in the taper shall have, for the length of the taper only, a six (6") inch fluorescent orange (ASTM Type VI, VII, VIII, IX or X) reflectorized top stripe on each drum. The top six-inch stripe may be temporarily attached to the drum while in use in a taper. The Engineer may allow the fluorescent orange reflectorized six (6") inch top stripe on each drum in a merging taper to remain in place during daylight hours provided there is a lane closure(s) with a continuous operation that begins during one nighttime period and ends during another nighttime period. All drums that have the six-inch top stripe permanently attached shall not be used for any other conditions.

Multiple Lane Closures:

- (a) A maximum of one lane at a time shall be closed with each merge taper.
 - (b) A minimum tangent length of 2 L shall be installed between each individual lane closure taper.
- 4) LONGITUDINAL CHANNELIZATION: Drums shall be spaced as listed below for various roadside work conditions except as modified by [Subsection 150.06](#).

Spacing shall be used for situations meeting any of the conditions listed as follows:

(a) 40 FOOT SPACING MAXIMUM

- (1) For difference in elevation exceeding two inches.
- (2) For heeled sections no steeper than 4:1 as shown in [Subsection 150.06](#), [Detail 150-E](#).

(b) 80 FOOT SPACING MAXIMUM

- (1) For difference in elevation of two inches or less.
- (2) Flush areas where equipment or workers are within ten feet of the travel lane.

(c) 200 FOOT SPACING MAXIMUM: Where equipment or workers are more than ten feet from travel lane. Lateral offset clearance to be four feet from the travel lane.

- (1) For paved areas eight feet or greater in width that are paved flush with a standard width travel lane.
- (2) For disturbed shoulder areas not completed to typical section that are flush to the travel lane and considered a usable shoulder.

REMOVAL OF DRUMS: Drums may be removed after shoulders are completed to typical section and grassed. Guardrail and other safety devices shall be installed and appropriate signs advising of conditions such as soft or low shoulder shall be posted before the drums are removed.

b. VERTICAL PANELS

- 1) DESIGN: All vertical panels shall meet the minimum requirements of the MUTCD. All vertical panels shall have a minimum of 270 square inches of retro-reflective area facing the traffic and shall be mounted with the top of the reflective panel a minimum of 36" above the roadway.
- 2) APPLICATION: Lane encroachment by the drum on the travelway should permit a remaining lane width of ten feet. When encroachment reduces the travelway to less than ten feet, vertical panels shall be used to restore the travelway to ten feet or greater. No other application of vertical panels will be permitted.

c. CONES

- 1) DESIGN: All cones shall be a minimum of 28 inches in height regardless of application and shall meet the requirement of the MUTCD. ReflectORIZATION may be deleted from all cones.
- 2) APPLICATION: For longitudinal channelizing only, cones will be permitted for daylight closures or minor shifts. (Drums are required for all tapers.) The use

of cones for nighttime work will not be permitted. Cones shall not be stored or allowed to be visible on the worksite during nighttime hours.

d. BARRICADES

DESIGN: Type III barricades shall meet the minimum requirements of the MUTCD and shall be reflectorized as required in [Subsection 150.01.C](#). The Contractor has the option of choosing Type III barricades from the Qualified Products List or the Contractor may utilize generic barricades that are approved by the Federal Highway Administration (FHWA). When barricades have been specifically crash tested with signs attached, the contractor has the responsibility to attach the signs as per the manufacturer's recommendations to ensure crashworthiness. If signs are attached to generic barricades or to barricades from the Qualified Products List (QPL) that have not been crash tested with signs attached then the responsibility for crashworthiness and the liability for mounting these signs to the barricades are assumed by the Contractor and the Contractor shall certify that the barricades are crashworthy under FHWA workzone guidelines for NCHRP 350 crashworthy compliance. Any generic barricades used in the work shall be stamped or stenciled to show compliance with NCHRP 350. The use of Type I and Type II barricades will not be permitted.

- 1) APPLICATION: Type III barricades shall be placed as required by the plans, the Standards, and as directed by the Engineer. All signs mounted on barricades shall be mounted to comply with the requirements of the MUTCD and NCHRP 350 Test Level III. NCHRP 350 crashworthy compliance may require that rigid signs be mounted separate from the Type III barricade.

When a barricade is placed so that it is subject to side impact from a vehicle, a drum shall be placed at the side of the barricade to add target value to the barricade.

e. WARNING LIGHTS:

- 1) DESIGN: All warning lights shall meet the requirements of the MUTCD.
- 2) APPLICATION
 - (a) Type A low-intensity flashing lights shall be used as shown in the Plans, the Standards, and as directed by the Engineer. Flashing lights are not required for advance warning signs in [Subsection 150.03.H](#).
 - (b) Type C Steady-Burn lights shall be used as shown in the Plans, the Standards, and as directed by the Engineer. Steady-burn lights are not required on drums for merging tapers that exist into the night.

f. TEMPORARY BARRIERS

- 1) DESIGN: Temporary barriers shall meet the requirements of Sections 620.
- 2) APPLICATION: Temporary barriers shall be placed as required by the plans, standards, and as directed by the Engineer. When Temporary barrier is located

20 feet or less from a travel lane, yellow reflectors shall be fixed to the top of the barrier at intervals not greater than 40 feet in the longitudinal section and 20 feet in the taper section and shall be mounted approximately two inches above the barrier. If both lanes of a two-lane two-way roadway are within 20 feet or less of the barrier then the reflectors shall be installed for both directions of traffic.

The reflectors shall be 100 square inches (ASTM Type VII or VIII) reflective sheeting mounted on flat-sheet blanks. The reflectors shall be mounted approximately two inches above the top of the barrier. The reflectors shall be attached to the barrier with adhesive or by a drilled-in anchor type device. The reflectors shall not be attached to a post or board that is placed between the gap in the barrier sections.

Approach end of Temporary barrier shall be flared or protected by an impact attenuator (crash cushion) or other approved treatment in accordance with Construction Details/Standards and Standard Specifications.

On interstate or other controlled access highways where lane shifts or crossovers cause opposing traffic to be separated by less than 40 ft., portable barrier shall be used as a separator.

B. PORTABLE IMPACT ATTENUATORS:

1. DESCRIPTION

This work consists of the furnishing (including spare parts), installation, maintenance, relocation, reuse as required, and removal of Portable Impact Attenuator Units/Arrays.

2. MATERIALS

Materials used in the Attenuator shall meet the requirements of [Section 648](#) for Portable Impact Attenuators.

3. CONSTRUCTION

Portable Impact Attenuator Unit/Arrays installation shall conform to the requirements of [Section 648](#), Manufacturer's recommendations and Georgia Standard 4960 and shall be installed at locations designated by the Engineer, and/or as shown on the plans.

C. TEMPORARY GUARDRAIL ANCHORAGE- Type 12:

1. DESCRIPTION

This work consists of the furnishing, installation, maintenance and removal or Temporary Guardrail Anchorage- Type 12 used for Portable Barrier or temporary guardrail end treatment.

2. MATERIALS

Materials used in the Temporary Guardrail Anchorage- Type 12 shall meet the requirements of [Subsection 641.2](#) of the Specifications and current Georgia Standards and may be new or used. Materials salvaged from the Project which meet the requirements of Standards may be utilized if available. The use of any salvaged materials will require prior approval of the Engineer.

3. CONSTRUCTION

Installation of the Temporary Guardrail Anchorage- Type 12 shall conform to the requirements of the Plans, current Georgia Standards and [Subsection 641.3](#) of the Specifications. Installation shall also include sufficient additional guardrail and appurtenances to effect the transition and connection to Temporary Concrete Barrier as required by the details in Georgia Standard 4960.

150.06 DIFFERENCES IN ELEVATION BETWEEN TRAVEL LANES AND SHOULDERS (SEE [SUBSECTION 150.06.G](#) FOR PROJECTS CONSISTING PRIMARILY OF ASPHALTIC CONCRETE RESURFACING ITEMS)

Any type of work such as paving, grinding, trenching, or excavation that creates a difference in elevation between travel lanes or between the travelway and the shoulder shall not begin until the Contractor is prepared and able to continuously place the required typical section to within two inches (2") of the existing pavement elevation. For any areas that the two inches minimum difference in elevation cannot be accomplished the section shall be healed as shown in [Detail 150-E](#). If crushed stone materials are used to provide a healed section no separate payment will be made for the material used to heal any section. The Contractor may submit a plan to utilize existing pay items for crushed stone provided the plan clearly demonstrates that the materials used to heal an area will be incorporated into the work with minimal waste. Handling and hauling of any crushed stone used to heal shall be kept to a minimum. The Engineer shall determine if the crushed stone used to heal meets the specifications for gradation and quality when the material is placed in the final location.

A maximum of sixty (60) calendar days shall be allowed for conditions to exist that require any section or segment of the roadway or ramp to continue to require a healed section as described by [Detail 150-E](#). Failure to meet this requirement shall be considered as non-performance of Work under [Subsection 150.08](#).

When trenching or excavation for minor roadway or shoulder widening is required, all operations at one site shall be completed to the level of the existing pavement in the same work day.

Any channelization devices utilized in the work shall conform to the requirements of [Subsection 150.05](#) and to the placement and spacing requirements in [Details 150-B](#), [150-C](#), [150-D](#), and [150-E](#) shown in this section.

Any construction activity that reduces the width of a travel lane shall require the use of a W-20 sign with the legend "LEFT/RIGHT LANE NARROWS". Two 24" x 24" red or red/orange flags may be mounted above the W-20 sign. The W-20 sign shall be located on the side of the travelway that has been reduced in width just off the travelway edge of pavement. The W-20 sign shall be a minimum of 500 feet in advance of any channelization devices that encroach on the surface of travelway. A portable changeable message sign may be used in lieu of the W-20 sign.

GENERAL/TIME RESTRICTIONS:

A. STONE BASES, SOIL AGGREGATE BASE AND SOIL BASES

1. All Highways

Differences in elevation of more than two inches between surfaces carrying or adjacent to traffic will not be allowed for more than a 24-hour period. A single length of

excavated area that does not exceed 1000 feet in total length may be left open as a start up area for periods not to exceed 48 hours provided the Contractor can demonstrate the ability to continuously excavate and backfill in a proficient manner. Prior approval of the Engineer shall be obtained before any startup area may be allowed.

2. LIMITED ACCESS HIGHWAY RAMPS (INTERSTATES):

On projects that include ramp rehabilitation work, one ramp at a time may be excavated for the entire length of the ramp from the gore point of the ramp with the interstate mainline to the intersection with the crossing highway. This single ramp may remain excavated with a vertical difference in elevation greater than two (2") inches for a maximum of fourteen (14) calendar days with drums spaced at twenty (20') feet intervals as shown in Detail 150-B and a buffer space accepted under Section 150.06.F. After fourteen (14) calendar days the section shall be healed as required for all other highways. This area will be allowed in addition to the 1000 feet allowed for all other highways.

B. ASPHALT BASES, BINDERS AND TOPPING

1. DIFFERENCES IN ELEVATION BETWEEN THE SURFACES OF ADJACENT TRAVELWAYS

Travel lanes shall be paved with a plan that minimizes any difference in elevation between adjacent travel lanes. The following limitations will be required on all work:

- a. Differences of two inches (2") or less may remain for a maximum period of fourteen (14) calendar days.
- b. Differences of greater than two inches (2") shall be permitted for continuous operations only.

EMERGENCY SITUATIONS: Inclement weather, traffic accidents, and other events beyond the control of the Contractor may prevent the work from being completed as required above. The Contractor shall notify the Engineer in writing stating the conditions and reasons that have prevented the Contractor from complying with the time limitations. The Contractor shall also outline a plan detailing immediate steps to complete the work. Failure to correct these conditions on the first calendar day that conditions will allow corrective work shall be considered as non-performance of Work under [Subsection 150.08](#).

2. Differences in Elevation Between Asphalt Travelway and Paved Shoulders

Differences in elevation between the asphalt travelway and asphalt paved shoulders shall not be allowed to exist beyond the maximum durations outlined below for the conditions shown in [Details 150-B](#), [150-C](#), [150-D](#), and [150-E](#):

Detail 150-B conditions shall not be allowed for more than 24 hours. A single length that does not exceed 1000 feet in total length may be left open for periods not to exceed 48 hours provided the Contractor can demonstrate the ability to continuously pave in a proficient manner. Prior approval of the Engineer shall be obtained before any section is allowed to exceed 24 hours. Any other disturbed shoulder areas shall be healed as in [Detail 150-E](#).

[Detail 150-C](#) conditions will not be allowed for more than 48 hours.

[Detail 150-D](#) conditions will not be allowed for more than 30 calendar days.

[Detail 150-E](#) conditions will not be allowed for more than 60 calendar days.

Failure to meet these requirements shall be considered as non-performance of Work under [Subsection 150.08](#).

C. PORTLAND CEMENT CONCRETE

Work adjacent to a Portland Cement Concrete traveled way which involves the following types of base and shoulders shall be accomplished according to the time restrictions outlined for each type of base or shoulder. Traffic control devices shall be in accordance with [Subsection 150.05](#).

1. Cement Stabilized Base

Work adjacent to the traveled way shall be healed as per [Detail 150-E](#) within forty-eight (48) hours after the seven (7) calendar day curing period is complete for each section placed. During the placement and curing period, traffic control shall be in accordance [Detail 150-B](#).

2. Asphaltic Concrete Base

When an asphaltic concrete base is utilized in lieu of a cement stabilized base the asphaltic concrete base shall be healed as per [Detail 150-E](#) within forty-eight (48) hours after the placement of each section of asphaltic concrete base. For the first forty eight hours traffic control shall be in compliance with [Detail 150-B](#).

3. Concrete Paved Shoulders

Concrete paved shoulders shall be placed within sixty (60) calendar days after the removal of each section of existing shoulder regardless of the type of base materials being placed on the shoulders. During the placement period, traffic control devices shall be in accordance with the appropriate detail based on the depth of the change in elevation. Differences in elevation of more than two inches between the travel way and the shoulder will not be allowed for more than a 24-hour period. A single length of excavated area that does not exceed 1000 feet in total length may be left open as a start up area for periods not to exceed 48 hours provided the Contractor can demonstrate the ability to continuously excavate and backfill in a proficient manner. Prior approval of the Engineer shall be obtained before any startup area may be allowed. Any other disturbed shoulder areas shall be healed as in [Detail 150-E](#).

4. Asphaltic Concrete Shoulders

A difference in elevation that meets the requirements of [Detail 150-B](#) shall not be allowed to exist for a period greater than forty-eight (48) hours. After the removal of the existing shoulder the section or segment of travelway may be healed with stone as per [Detail 150-E](#) for a maximum of fourteen (14) calendar days. Asphaltic concrete shoulders shall be placed within two (2") inches or less of the traveled way surface within fourteen (14) calendar days after the removal of the stone healed section or the removal of each section of the existing shoulder. The two (2") inches or less difference in elevation shall not remain in existence for a period that exceeds thirty (30) calendar days unless the paved shoulder is utilized as a detour for the traveled way. During the placement period, traffic control shall be in accordance with the appropriate detail based on the depth of the change in elevation.

The Contractor may propose an alternate plan based on [Subsection 150.06.F](#). Failure to meet the above requirements and time restrictions shall be considered as non-performance of Work under [Subsection 150.08](#).

D. MISCELLANEOUS ELEVATION DIFFERENTIALS FOR EXCAVATIONS ADJACENT TO THE TRAVELWAY

Drainage structures, utility facilities, or any other work which results in a difference in elevation adjacent to the travelway shall be planned and coordinated to be performed in such a manner to minimize the time traffic is exposed to this condition. The excavation should be back filled to the minimum requirements of [Detail 150-E](#) as soon as practical. Stage construction such as plating or backfilling the incomplete work may be required. The difference in elevation shall not be allowed to exist for more than five (5) calendar days under any circumstances. Failure to correct this condition shall be considered as non-performance of Work under [Subsection 150.08](#).

E. CONDUIT INSTALLATION IN PAVED AND DIRT SHOULDERS

The installation of conduit and conduit systems along the shoulders of a traveled way shall be planned and installed in a manner to minimize the length of time that traffic is exposed to a difference in elevation condition. The following restrictions and limitations shall apply:

1. Differences in Elevation of Two (2") Inches or Less

The shoulder may remain open when workers are not present. When workers are present the shoulder shall be closed and the channelization devices shall meet the requirements of [Subsection 150.05](#). The difference in elevation on the shoulder shall remain for a maximum period of fourteen (14) calendar days.

2. Differences in Elevation Greater Than Two (2") Inches

The shoulder shall be closed. The shoulder closure shall not exceed twenty-four (24) hours in duration unless the Special Conditions in Subsection 150.11 modifies this restriction or the Engineer allows the work to be considered as a continuous operation.

Failure to meet these requirements shall be considered as non-performance of Work under [Subsection 150.08](#).

F. MODIFICATIONS TO TIME RESTRICTIONS

The Contractor may propose any alternate temporary traffic control plan that utilizes a portion of the travel lane as a "buffer space". This buffer space may allow for an enhanced work area that will allow for the placement of materials to proceed at a pace that could not be achieved with the time restriction requirements outlined in [Section 150.06.A](#), [150.06.B](#), and [150.06.C](#). The Contractor may propose modified time restrictions based on the use of the buffer space. Any proposed modifications in the time duration allowed for the differences in elevations to exist shall be reviewed by the Engineer as a component of the overall TTC plan. No modifications shall be made until the proposed plan is accepted by

the Engineer. The Engineer shall have no obligation to consider any proposal which results in an increase in cost to the Department.

For the travel lane described in each of the [details 150-B](#), [150-C](#), [150-D](#) and [150-E](#) it is presumed that the pavement marking edgeline (yellow or white solid stripe) is located at the very edge of the travel lane surface. A buffer space (temporary paved shoulder) that utilizes a portion of the travel lane should be six (6') feet in width desirable but shall not be less than four (4') feet in width. Any remaining travel lane(s) shall not be less than ten (10') feet in width. Modifications to drum spacing shown in the details above will not be allowed.

If the proposed shifting of the traffic to obtain a buffer space and maintain a minimum travel lane(s) of ten (10') feet requires the use of any existing paved shoulders then the cost of maintenance and repair of the existing paved shoulder(s) shall be the responsibility of the Contractor. The Contractor is responsible for the costs of maintenance and repairs even if the existing paved shoulder(s) is to be removed in a later stage of the work. Existing shoulders that have rumble strips shall have the rumble strips removed before the shoulder can be utilized as part of the travel lane. The cost of the removal of the rumble strips shall be done at no cost to the Department even if the shoulder is to be removed in a later stage of the work.

Any modifications to the staging and time restrictions that are approved as part of the TTC plan shall be agreed to in writing. Failure to meet these modifications shall be considered as non-performance of the Work under [Subsection 150.08](#).

G. ASPHALTIC CONCRETE RESURFACING PROJECTS

SHOULDER CONSTRUCTION INCLUDED AS A PART OF THE CONTRACT: When the placement of asphaltic concrete materials creates a difference in elevation greater than two (2") inches between the earth shoulder (grassed or un-grassed) and the edge of travelway or between the earth shoulder and a paved shoulder that is less than four (4') feet in width, the Contractor shall place and maintain drums in accordance with the requirements of [Subsection 150.05A.1.a.4](#)). When the edge of the paved surface is tapered with a 30-45 degree wedge, drums may be spaced at 2.0 times the speed limit in MPH. Drums shall remain in place and be maintained until the difference in elevation has been eliminated by the placement of the appropriate shoulder materials.

SHOULDER CONSTRUCTION NOT INCLUDED AS A PART OF THE CONTRACT: When the placement of asphaltic concrete materials creates a difference in elevation greater than two (2") inches between the earth shoulder (grassed or un-grassed) and the edge of travelway or between the earth shoulder and a paved shoulder that is less than four (4') feet in width, the Contractor shall notify the Engineer, in writing, when the resurfacing work including all punchlist items has been completed.

See [Subsection 150.03.L](#) for the requirements for "LOW/SOFT SHOULDERS" and "SHOULDER DROP-OFF" signage.

Location of drums when Elevation Difference exceeds 4 inches. Drums spaced at 20 foot intervals. Note: If the travel way width is reduced to less than 10 feet by the use of drums, vertical panels shall be used in lieu of drums.	
---	--

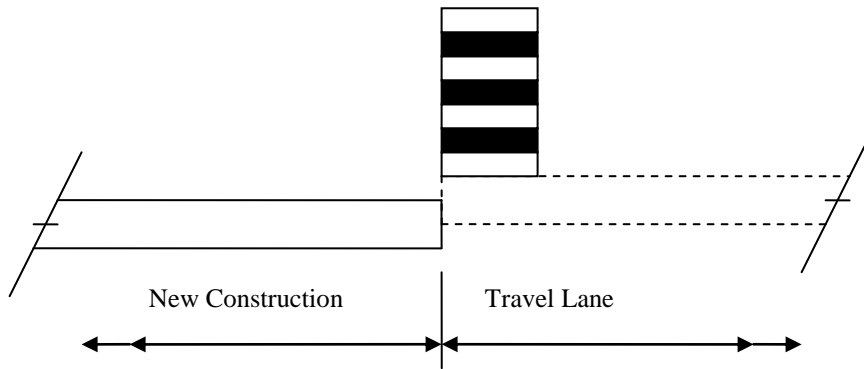

ELEVATION DIFFERENCE GREATER THAN 4 INCHES
DETAIL 150-B

Drums spaced at 40 foot intervals.	Location of drums when Elevation Difference is 2+ inches to 4 inches.
------------------------------------	---

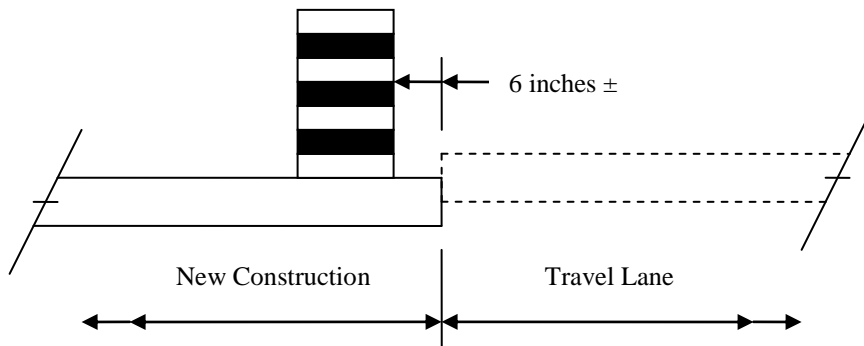

ELEVATION DIFFERENCE 2+ to 4 inches

DETAIL 150-C

Drums spaced at 80 foot intervals.	Location of drums when Elevation Difference is 2 inches or less.
------------------------------------	--

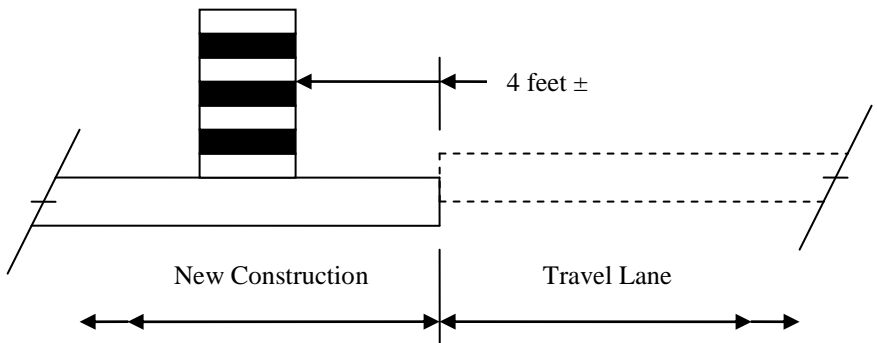

ELEVATION DIFFERENCE OF 2 INCHES OR LESS

DETAIL 150-D

	Location of drums immediately after completion of healed sections spaced at 40 foot intervals.
--	--

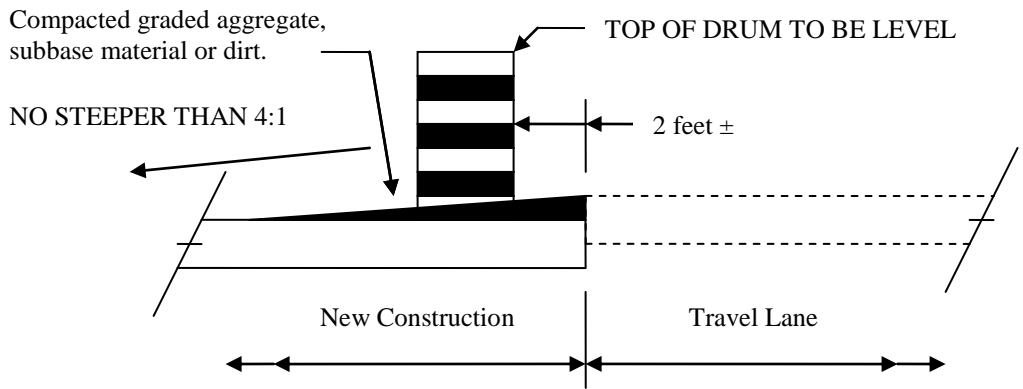

HEALED SECTION

DETAIL 150-E

150.07 FLAGGING AND PILOT CARS:

A. FLAGGERS

Flaggers shall be provided as required to handle traffic, as specified in the Plans or Special Provisions, and as required by the Engineer.

B. FLAGGER CERTIFICATION

All flaggers shall meet the requirements of the MUTCD and shall have received training and a certificate upon completion of the training from one of the following organizations:

National Safety Council
Southern Safety Services
Construction Safety Consultants
Ivey Consultants
American Traffic Safety Services Association (ATSSA)

Certifications from other agencies will be accepted only if their training program has been approved by any one of the organizations listed above.

Failure to provide certified flaggers as required above shall be reason for the Engineer suspending work involving the flagger(s) until the Contractor provides the certified flagger(s). Flaggers shall have proof of certification and valid identification (photo I.D.) available any time they are performing flagger duties.

C. FLAGGER APPEARANCE AND EQUIPMENT

Flaggers shall wear high-visibility clothing in compliance with [Subsection 150.01.A](#) and shall use a Stop/Slow paddle meeting the requirements of the MUTCD for controlling traffic. The Stop/Slow paddles shall have a shaft length of seven (7) feet minimum. The Stop/Slow paddle shall be retro-reflectorized for both day and night usage. In addition to the Stop/Slow paddle, a flagger may use a flag as an additional device to attract attention. This flag shall meet the minimum requirements of the MUTCD. The flag shall, as a minimum, be 24" inches square and red or red/orange in color. For night work, the vest shall have reflectorized stripes which meet the requirements of the MUTCD.

D. FLAGGER WARNING SIGNS

Signs for flagger traffic control shall be placed in advance of the flagging operation in accordance with the MUTCD. In addition to the signs required by the MUTCD, signs at regular intervals, warning of the presence of the flagger shall be placed beyond the point where traffic can reasonably be expected to stop under the most severe conditions for that day's work.

E. PILOT VEHICLE REQUIREMENTS

Pilot vehicles will be required during placement of bituminous surface treatment or asphaltic concrete on two-lane roadways unless otherwise specified. Pilot vehicles shall meet the requirements of the MUTCD.

F. PORTABLE TEMPORARY TRAFFIC CONTROL SIGNALS

The Contractor may request, in writing, the substitution of portable temporary traffic control signals for flaggers on two-lane two-way roadways provided the temporary signals meets the requirements of the MUTCD, [Section 647](#), and [Subsection 150.02.A.8](#). As a part of this request, the Contractor shall also submit an alternate temporary traffic control plan in the event of a failure of the signals. Any alternate plan that requires the use of flaggers shall include the use of certified flaggers. The Contractor shall obtain the approval of the Engineer before the use of any portable temporary traffic control signals will be permitted.

150.08 ENFORCEMENT

The safe passage of pedestrians and traffic through and around the temporary traffic control zone, while minimizing confusion and disruption to traffic flow, shall have priority over all other Contractor activities. Continued failure of the Contractor to comply with the requirements of Section 150 (TRAFFIC CONTROL) will result in non-refundable deductions of monies from the Contract as shown in this Subsection for non-performance of Work.

Failure of the Contractor to comply with this Specification shall be reason for the Engineer suspending all other work on the Project, except erosion control and traffic control, taking corrective action as specified in [Subsection 105.15](#), and/or withholding payment of monies due to the Contractor for any work on the Project until traffic control deficiencies are corrected. These other actions shall be in addition to the deductions for non-performance of traffic control.

SCHEDULE OF DEDUCTIONS FOR EACH CALENDAR DAY OF DEFICIENCIES OF TRAFFIC CONTROL INSTALLATION AND/OR MAINTENANCE		
ORIGINAL TOTAL CONTRACT AMOUNT		
From More Than	To and Including	Daily Charge
\$0	\$100,000	\$200
\$100,000	\$1,000,000	\$500
\$1,000,000	\$5,000,000	\$1,000
\$5,000,000	\$20,000,000	\$1,500
\$20,000,000	\$40,000,000	\$2,000
\$40,000,000	\$-----	\$3,000

150.09 MEASUREMENT

A. TRAFFIC CONTROL

When listed as a pay item in the Proposal, payment will be made at the Lump Sum price bid, which will include all traffic control not paid for separately, and will be paid as follows:

When the first Construction Report is submitted, a payment of 25 (twenty-five) percent of the Lump Sum price will be made. For each progress payment thereafter, the total of the

Project percent complete shown on the last pay statement plus 25 (twenty-five) percent will be paid (less previous payments), not to exceed one hundred (100) percent.

When no payment item for *Traffic Control-Lump Sum* is shown in the Proposal, all of the requirements of Section 150 and the Temporary Traffic Control Plan shall be in full force and effect. The cost of complying with these requirements will not be paid for separately, but shall be included in the overall bid submittal.

B. SIGNS

When shown as a pay item in the contract, interim special guide signs will be paid for as listed below. All other regulatory, warning, and guide signs, as required by the Contract, will be paid for under Traffic Control Lump Sum or included in the overall bid submitted.

1. Interim ground mounted or interim overhead special guide signs will be measured for payment by the square foot. This payment shall be full compensation for furnishing the signs, including supports as required, erecting, illuminating overhead signs, maintaining, removing, re-erecting, and final removal from the Project. Payment will be made only one time regardless of the number of moves required.
2. Remove and reset existing special guide signs, ground mount or overhead, complete, in place, will be measured for payment per each. Payment will be made only one time regardless of the number of moves required.
3. Modify special guide signs, ground mount or overhead, will be measured for payment by the square foot. The area measured shall include only that portion of the sign modified. Payment shall include materials, removal from posts or supports when necessary, and remounting as required.

C. TEMPORARY BARRIER

Temporary Barrier shall be measured as specified in [Sections 620](#).

D. CHANGEABLE MESSAGE SIGN, PORTABLE

Changeable Message Sign, Portable will be measured as specified in [Section 632](#).

E. TEMPORARY GUARDRAIL ANCHORAGE, Type 12

Temporary Guardrail Anchorage- Type 12 will be measured by each assembly, complete in place and accepted according to the details shown in the plans, which shall also include the additional guardrail and appurtenances necessary for transition and connection to Temporary Concrete Barrier. Payment shall include all necessary materials, equipment, labor, site preparation, maintenance and removal.

F. TRAFFIC SIGNAL INSTALLATION- TEMPORARY

Traffic Signal Installation- Temporary will be measured as specified in [Section 647](#).

G. FLASHING BEACON ASSEMBLY

Flashing Beacon Assemblies will be measured as specified in [Section 647](#).

H. PORTABLE IMPACT ATTENUATORS

Each Portable Impact Attenuator will be measured by the unit/array which shall include all material components, hardware, incidentals, labor, site preparation, and maintenance, including spare parts recommended by the manufacturer for repairing accident damage. Each unit will be measured only once regardless of the number of locations installed, moves required, or number of repairs necessary because of traffic damage. Upon completion of the project, the units shall be removed and retained by the Contractor.

I. PAVEMENT MARKINGS

Pavement markings will be measured as specified in Section 150.

J. TEMPORARY WALKWAYS WITH DETECTABLE EDGING

Temporary walkways with detectable edging will be measured in linear feet (meters), complete in place and accepted, which shall include all necessary materials, equipment, labor, site preparation, temporary pipes, passing spaces, maintenance and removal. Excavation and backfill are not measured separately for payment. No payment will be made for temporary walkways where existing pavements or existing edging (that meets the requirements of MUTCD) are utilized for the temporary walkway. Payment for temporary detectable edging, including approved barriers and channelizing devices, installed on existing pavement shall be included in Traffic Control-Lump Sum.

K. TEMPORARY CURB CUT WHEELCHAIR RAMPS

Temporary curb cut wheelchair ramps are measured as the actual number formed and poured, complete and accepted, which shall include all necessary materials, equipment, labor, site preparation, maintenance and removal. No additional payment will be made for sawing existing sidewalk and removal and disposal of removed material for temporary wheelchair ramp construction. No additional payment will be made for constructing the detectable warning surface.

L. TEMPORARY AUDIBLE INFORMATION DEVICE

Temporary audible information devices are measured as the actual number furnished and installed in accordance with the manufacturer’s recommendations, which shall include all necessary materials, equipment, labor, site preparation, maintenance and removal. Each temporary audible information device will be paid for only one time regardless of the number of times it’s reused during the duration of The Work. These devices shall remain the property of the Contractor.

150.10 PAYMENT:

All items described in the specification shall be paid for under CONSTRUCTION COMPLETE with the exception of Work Zone Law Enforcement. This will be paid for under:

Item No. 150. Traffic Control, Workzone Law Enforcementper hour.

First Use Date: August 1, 2003
June 10, 2005
May 5, 2006
February 4, 2008

**DEPARTMENT OF TRANSPORTATION
STATE OF GEORGIA**

SPECIAL PROVISION

Project Number: CSNHS-0008-00(415)

P.I. Number: 0008415

Fulton County

Section 153 – Field Engineer’s Office

Delete Subsection 153.3.05 B.7 and substitute the following:

7. Worktable: Provide a minimum of three (3) standard dimension desks. They shall be provided with a minimum of 1 1/8" (28mm) wood grain laminated tops with 23" (575mm) deep files and heavy-duty steel ball bearing drawers and locking center drawer. Provide one (1) 5' X 3' (1500mmX900mm) adjustable from 0 to 45 degree and 38" (950mm) high drafting table.

Delete Subsection 153.3.05 B.8 and substitute the following:

8. Stools: Provide one (2) posture stool with supportive backrest, waterfall edge seat and instant height lever (26" to 30")(650mm to 750mm). Provide a minimum of five (5) fully braced stackable full 2" (50mm) thick 16"X15" (400mmX375mm) seats with armrests and chrome frames. Provide a minimum of four (6) swivel chairs with arms and a 19"X19" (475mmX475mm) foam cushion and upholstered seat adjustable from 16 1/2" to 20" (415mm to 500mm) high.

Retain Subsection 153.3.05 B.11 and add the following:

Process and pay the monthly bills for all utility services.

Delete Subsection 153.3.05 B.12 and substitute the following:

12. Electric Service: Provide 120/240 volt electric service that meets code.

Delete Subsection 153.3.05 B.15 and substitute the following:

15. Telephone: Provide in each Type 3 building, four telephones. Provide two voice lines, with rollover capabilities, connected to two handsets (located on either end of the office). Provide separate telephone lines for the computer and the fax machine, as directed by the Engineer. Install and maintain these lines for the life of the Project. Provide telephone access to Local and Long Distance Telephone Service for incoming and outgoing calls and fax.

Provide with the telephone, an automatic answering system that can give a greeting message, record incoming messages, and activate remotely.

Delete Subsection 153.3.05 C.6 and substitute the following:

6. Outside Electrical Receptacle – Provide a weather-proof, exterior 220-volt electrical receptacle attached to a power source.

Delete Subsection 153.3.05 C.7 and substitute the following:

7. Chain Link Fence – Provide a minimum of 500 feet (150m) of 6 ft. (1.8 m) high chain link fence with an extension arm and barbed wire as specified in Section 643. Equip the fence with matching gates and meeting the requirements of Section 643 and consisting of a double 7 ft. (2.1m) by 6 ft. (1.8 m) and a single 4 ft.(1.2 m) by 6 ft. (1.8 m) gate. Include a positive-type locking devices, padlock and a minimum of two keys for each gate. Ensure the fence encompasses the entire compound.

Delete Subsection 153.3.05 C.8 and substitute the following:

8. Security Light – Provide two 150-watt high-pressure sodium security lights with photoelectric controls. Place as directed by the Engineer.

Delete Subsection 153.3.05 C.9 and substitute the following:

9. Copying Machine – The Contractor shall furnish the Field Office with one copying machine installed and maintained for the life of the Project. The copying machine shall have the capability of making letter-size copies (8 ½” x 11”), legal-size copies (8 ½”x 14”), two-sided copies, at least thirty copies per minute, and possess an auto-feed feature. Furnish all consumable and non-consumable supplies for the life of the Project. The copying machine shall also have the capability to scan documents to an adobe .pdf format, and then automatically email the file to specific email accounts.

Add the following to Subsection 153.3.05 C:

10. Place and spread 200 tons (181 Mg) of aggregate surface course on the Office grounds where indicated by the Engineer to facilitate parking. Remove aggregate and grass the area upon completion of the Project.
11. Ensure that the Office is supported with concrete blocks with mortar joints and anchored with ten storm-tie-down anchors. Enclose the area between the ground and the bottom of the Office with a vinyl skirting that matches the Office’s siding.
12. Install an alarm system that includes the following items and maintain in good operating condition:
 - SRN-2000 Enforced Bionic with NAPCO Magnum Alert 850 – control box or Honeywell Vista-10P Master Control Panel with Honeywell 6150RF keypad or equivalent.
 - All doors and windows with wired contacts.
 - Outside sirens with wired contacts.
 - Tamper-proof box with wired contacts.
 - Inside sirens with wired contacts.
 - Two smoke and heat detectors.

Tie all of the above equipment to a 24 hour control monitoring system (BRK –2812TH or equivalent). Use a wired keyboard system. Do not use a remote system.

Process and pay the monthly bills for the alarm system and monitoring.

13. Furnish the fax machine in good operating condition and maintain it throughout the life of the Contract. Furnish all consumable and non-consumable supplies for the life of the Project.
14. Provide two (2) additional 4 drawer locking fireproof file cabinets.
15. Provide one Desktop Computer and Accessories meeting the following minimum requirements
 - A. Hardware:
 - 1.7 GHz Processor or better
 - 512 MB RAM
 - 80 GB Hard Drive or larger
 - 40X Max, CD-RW
 - 3.5" (90 mm) Floppy Drive
 - 64 MB Video memory
 - V.90 PCI DataFax Modem w/Voice
 - 17" (431 mm) Color Monitor
 - Human Input Device (Mouse)
 - Standard Windows Keyboard
 - B. Software:
 - MS Windows XP **Professional**
 - MS Office XP **Professional**
 - MS Outlook (Most Recent Version)
 - WinZip
 - WS-FTP
 - A restore CD
 - C. Printers:
 - Hewlett-Packard Laser Jet 1020 or Brother HL-5140 or Approved Equal
 - D. Uninterruptible Power Supply:
 - American Power Conversion Corporation Back-UPS ES 650 or Newpoint 750 VA Battery Backup or Equal (minimum 5 Receptacles)
 - E. DSL or Cable Broadband Internet Service
 - Provide DSL Internet Service with static IP address or provide Cable Broadband Internet Service as directed by the Engineer.
16. Concrete Cylinder Curing Box – The Contractor shall furnish a Concrete Curing Box for any project that requires the placement of concrete. The curing box and its components shall be constructed of non-corroding materials and shall be capable of storing a minimum of 22 test cylinders, 6 inch x 12 inch (150 mm x 300 mm) stored vertically with the lid closed. Additional capacity may be required on large projects at the direction of the Engineer. The curing box shall be equipped with heating/cooling capabilities, automatic temperature control, and a maximum/minimum (high/low) temperature readout.

The curing box shall be capable of meeting the moisture and temperature requirements of AASHTO T 23.

17. For the life of the project, the Contractor shall provide a digital camera and a video camera. The actual equipment will be determined by the Engineer. Price of equipment, and associated hardware/software necessary to view files, shall not exceed \$1000.

Add the following to Subsection 153.3.07:

Retain possession of all items that are required as part of the Field Office when the Engineer determines that these items are no longer needed.

Delete Subsection 153.4 and 153.5:

Add the following Subsection 153.4:

Measurement and Payment:

No separate measurement will be made for the Field Engineer's Office. The Contractor shall provide a Type 3 Field Engineer's Office. All costs associated with the Field Engineer's Office Type 3 shall be included in the price bid for CONSTRUCTION COMPLETE. Costs included, but not limited to, are the following: providing a location, all materials, design, construction, furnishings, maintenance, fuel, water, sewage disposal, electricity and telephone service, movements, moving from the project, transformers, and any costs incurred for carrying electricity to the Field Engineer's Office.

Office of Construction

**DEPARTMENT OF TRANSPORTATION
STATE OF GEORGIA**

SPECIAL PROVISION

**Project Number: CSNHS-0008-00(415)
P.I. Number: 0008415
Fulton County**

Section 161—Control of Soil Erosion and Sedimentation

Add the following:

161.1 General Description

This Work includes using control measures shown on the Plans, ordered by the Engineer, or as required during the life of the Contract to control soil erosion and sedimentation through the use of any of the devices or methods referred to in this Section.

161.1.01 Definitions

Certified Personnel— certified personnel are defined as persons who have successfully completed the Level IA certification course approved by the Georgia Soil and Water Conservation Commission. For Department projects the certified person must also have successfully completed the Department's WECS certification course.

Design Professional as defined in the current GAR100002 NPDES permit.

161.1.02 Related References

A. Standard Specifications

[Section 105—Control of Work](#)

[Section 106—Control of Materials](#)

[Section 107—Legal Regulations and Responsibility to the Public](#)

[Section 109—Measurement and Payment](#)

[Section 160—Reclamation of Material Pits and Waste Areas](#)

[Section 162—Erosion Control Check Dams](#)

[Section 163—Miscellaneous Erosion Control Items](#)

[Section 166—Restoration or Alteration of Lakes and Ponds](#)

[Section 170—Silt Retention Barrier](#)

[Section 171—Temporary Silt Fence](#)

[Section 205—Roadway Excavation](#)

[Section 434—Sand Asphalt Paved Ditches](#)

[Section 441—Miscellaneous Concrete](#)

[Section 603—Rip Rap](#)

[Section 700—Grassing](#)

[Section 710—Permanent Soil Reinforcing Mat](#)

[Section 715—Bituminous Treated Roving](#)

[Section 716—Erosion Control Mats \(Blankets\)](#)

Erosion control measures contained in the Specifications include:

Erosion Control Measure	Section
Temporary Check Dams	163.3.05.J
Bituminous Treated Mulch	700.3.05.G
Concrete Paved Ditches	441
Bituminous Treated Roving	715
Erosion Control Mats (Blankets)	716
Erosion Control Check Dams	162
Grassing	700
Maintenance of Temporary Erosion Control Devices	165
Permanent Soil Reinforcing Mat	710
Reclamation of Material Pits and Waste Areas	160
Rip Rap	603
Restoration or Alteration of Lakes and Ponds	166
Sand-Asphalt Ditch Paving	434
Sediment Basin	163.3.05.C
Silt Control Gate	163.3.05.A
Silt Retention Barrier	170
Sod	700.3.05.H & 700.3.05.I
Mulch	163
Temporary Grassing	163.3.05.F
Temporary Silt Fence	171
Temporary Slope Drains	163.3.05.B
Triangular Sediment Barrier	720
Silt Filter Bag	719
Organic & Synthetic Material Fiber Blanket	713

B. Referenced Documents

Erosion and Sedimentation Pollution Control Plans (ESPCP)

161.1.03 Submittals

A. Status of Erosion Control Devices

The Worksite Erosion Control Supervisor (WECS) or certified personnel will inspect the installation and maintenance of the Erosion Control Devices according to [Subsection 167.3.05.B](#) and the ESPCP.

1. Submit all reports to the Engineer within 24 hours of the inspection. Refer to [Subsection 167.3.05.C](#) for report requirements.
2. The Engineer will review the reports and inspect the Project for compliance and concurrence with the submitted reports.
3. The Engineer will notify the WECS or certified personnel of any additional items that should be added to the reports.
4. Items listed in the report requiring maintenance or correction shall be completed within 72 hours.

B. Erosion and Sedimentation Pollution Control Plan

1. Project Plans

An erosion and sedimentation pollution control plan (ESPCP) for the construction of the project will be provided by the Department. The ESPCP will be prepared for the various stages of construction necessary to complete the project.

If the Contractor elects to alter the stage construction from that shown in the plans, it will be the responsibility of the Contractor to have the plans revised and prepared in accordance with the current GAR100002 NPDES permit by a Design Professional to reflect all changes in Staging. This will also include any revisions to erosion and sedimentation control item quantities. If the changes affect the Comprehensive Monitoring Program (CMP), the Contractor will be responsible for any revisions to the CMP as well. Submit revised plans and quantities to the Engineer for review prior to land disturbing activities.

2. Haul Roads, Borrow Pits, Excess Material Pits, etc.

The Contractor is responsible for preparing erosion and sedimentation control plans for construction access roads and or haul roads borrow pits, excess material pits, etc (inside the Right of Way). Prepare these plans for all stages of construction and include the appropriate items and quantities. Submit these plans to the Engineer for review prior to land disturbing activities. These plans are to be prepared by a Design Professional.

If construction of access roads, haul roads, borrow pits, excess material pits, etc., (inside the Right of Way) encroach within the 25 foot (7.6 m) buffer along the banks of all state waters or within the 50 ft. (15 m) buffer along the banks of any state waters classified as a "trout stream", a state water buffer variance must be obtained by the Contractor prior to beginning any land disturbing activity in the stream buffer.

3. Erosion Control for Borrow and Excess Material Pits Outside the Right-of-Way

Erosion control for borrow pits and excess material pits outside the right of way is the responsibility of the Contractor. If borrow or excess material pits require coverage under the National Pollutant Discharge Elimination System permit (NPDES) or other permits or variances are required, submit a copy of all documentation required by the permitting agency to the Engineer. All costs associated with complying with local, state, and federal laws and regulations are the responsibility of the Contractor.

4. Culverts and Pipes

The ESPCP does not contain approved methods to construct a stream diversion or stream diversion channel. The Contractor shall prepare a diversion plan utilizing a Design Professional as defined in the current NPDES permit. See 161.3.05 G for additional information.

5. Temporary Asphalt or Concrete Batch Plants

In addition to the requirements of any applicable specifications, if the Department authorizes the temporary installation and use of any asphalt, concrete or similar batch plants within its right of way, the contractor shall submit an NOI to the Georgia Environmental Protection Division for coverage under the following NPDES permits; The Infrastructure permit for the construction of

the plant, and the Industrial permit for the operation of, such a plant. The contractor shall submit the NOIs as both the Owner and the Operator.

161.2 Materials

General Provisions 101 through 150.

161.2.01 Delivery, Storage, and Handling

General Provisions 101 through 150.

161.3 Construction Requirements

161.3.01 Personnel

A. Duties of the Worksite Erosion Control Supervisor

Before beginning Work, designate a Worksite Erosion Control Supervisor (WECS) to initiate, install, maintain, inspect, and report the condition of all erosion control devices as described in Sections 160 through 171 or in the Contract and ESPCP documents. The designee shall submit their qualifications on the Department provided resume form for consideration and approval. The contractor may utilize additional persons having WECS qualifications to facilitate compliance however, only one WECS shall be designated at a time.

The WECS and alternates shall:

- Be an employee of the Prime Contractor.
- Have at least one year of experience in erosion and sediment control, including the installation, inspection, maintenance and reporting of BMPs.
- Successfully completed the Georgia Soil and Water Conservation Commission Certification Course Level IA and the Department's WECS Certification Course.
- Provide phone numbers where the WECS can be located 24 hours a day.

The WECS' duties include the following:

1. Be available or have an approved representative available 24 hours a day and have access to the equipment, personnel, and materials needed to maintain erosion control and flooding control.
2. Inform the Engineer in writing whenever the alternate WECS assumes project responsibilities.
3. Ensure that erosion control deficiencies are corrected within seventy two (72) hours or immediately during emergencies. Deficiencies that interfere with traffic flow, safety or downstream turbidity are to be corrected immediately.
4. During heavy rain, have the construction area patrolled day or night, any day of the week to quickly detect and correct erosion or flooding problems before they interfere with traffic flow, safety, or downstream turbidity.
5. Be on the site within three (3) hours after receiving notification of an emergency prepared to positively respond to the conditions encountered. The Department may handle emergencies without notifying the Contractor. The Department will recover costs for emergency maintenance work according to [Subsection 105.15, "Failure to Maintain Roadway or Structures."](#)

6. Maintain and submit for project record, “As-built” Erosion and Sedimentation Control Plans that supplement and graphically depict EC-1 reported additions and deletions of BMPs. The As-Built plans are to be accessed and retained at a Department facility at all times.
7. Ensure that both the WECS and the alternate meet the criteria of this Subsection.
8. The WECS shall maintain a current certification card for the duration of the project. Recertification of the WECS will be required prior to the expiration date shown on the Certification card in order to remain as Certified Personnel and the WECS for the project.

Failure of the WECS or alternate to perform the duties specified in the Contract, or whose performance, has resulted in a citation being received from a State or Federal Regulatory Agency, e.g. the Georgia Environmental Protection Division, shall result in one or more of the following;

- Suspension of the WECS’ certification for a period of not less than 30 days
- Removal of the Contractor’s project superintendent in accordance with Sections 105.05 and 108.05 for a period not less than 14 days
- Department wide revocation of the WECS certification for a period of 12 months
- Removal of the Contractor’s project superintendent in accordance with Sections 105.05 and 108.05

161.3.02 Equipment

General Provisions 101 through 150.

161.3.03 Preparation

General Provisions 101 through 150.

161.3.04 Fabrication

General Provisions 101 through 150.

161.3.05 Construction

Coordinate the temporary and permanent erosion control provisions in this Specification with the permanent erosion control provisions in the Contract to ensure economical, effective, and continuous erosion control throughout the construction and post-construction periods.

At all times that land disturbing activity is underway, a person meeting the requirements of, “certified person” by the GSWCC (Level IA) must be on the project.

A. Control Dust Pollution

The contractor shall keep dust pollution to a minimum during any of the activities performed on the project. It may be necessary to apply water or other BMPs to roadways or other areas reduce pollution.

B. Perform Permanent or Temporary Grassing

Perform permanent grassing, temporary grassing, or mulching on cut and fill slopes weekly (unless a shorter period is required by Subsection 107.23) during grading operations. When conditions warrant, the Engineer may require more frequent intervals.

Under no circumstances shall the grading (height of cut) exceed the height operating range of the grassing equipment. It is extremely important to obtain a cover, whether it is mulch, temporary grass or permanent grass. Adequate mulch is a must.

When grading operations or other soil disturbing activities have stopped, perform grassing or erosion control as shown in the Plans, as shown in an approved Plan submitted by the Contractor, or as directed by the Engineer.

C. Seed and Mulch

Refer to Subsection [161.3.05.B, “Perform Permanent or Temporary Grassing”](#).

D. Implement Permanent or Temporary Erosion Control

1. Silt fence shown along the perimeter, e.g. right of way, and sediment containment devices, e.g. sediment basins, shall be installed prior to or concurrently with clearing and grubbing operations.
2. Incorporate permanent erosion control features into the Project at the earliest practicable time, e.g. velocity dissipation, permanent ditch protection.
3. Use temporary erosion control measures to address conditions that develop during construction but were unforeseen during the design stage.
4. Use temporary erosion control measures when installation of permanent erosion control features cannot be accomplished.

The Engineer has the authority to:

- Limit the surface area of erodible earth material exposed by clearing and grubbing.
- Limit the surface area of erodible earth material exposed by excavation and borrow and fill operations.
- Limit the area of excavation, and embankment operations in progress to correspond with the Contractor’s ability to keep the finish grading, mulching, seeding, and other permanent erosion control measures current.
- Direct the Contractor to provide immediate permanent or temporary erosion control to prevent contamination of adjacent streams or water courses, lakes, ponds, or other areas of water impoundment.

Such Work may include constructing items listed in the table in [Subsection 161.1.02.A, “Related References”](#) or other control devices or methods to control erosion.

E. Erodible Area

NOTE: Never allow the surface area of erodible earth material exposed at one time to exceed 17 acres (7 ha) except as approved by the State Construction Engineer.

The maximum of 17 acres (7 ha) of exposed erodible earth applies to the entire Project and to all of its combined operations as a whole, not to the exposed erodible earth of each individual operation.

Upon receipt of a written request from the contractor the State Construction Engineer, or his designee, will review; the request, any justifications and the Project conditions for waiver of the 17 acres (7 ha) limitation.

If the 17 acre limitation is increased by the State Construction Engineer, the WECS shall not be assigned to another project in that capacity and should remain on site each work day that the exposed acreage exceeds 17 acres.

After installing temporary erosion control devices, e.g., grassing, mulching, stabilizing an area, and having it approved by the Engineer, that area will be released from the 17 acres (7 ha) limit.

F. Perform Grading Operations

Perform the following grading operations:

1. Complete each roadway cut and embankment continuously, unless otherwise specified in the Contract or ordered by the Engineer.
2. Maintain the top of the earthwork in roadway sections throughout the construction stages to allow water to run off to the outer edges. .
3. Provide temporary slope drain facilities with inlets and velocity dissipaters (straw bales, silt fence, aprons, etc.) to carry the runoff water to the bottom of the slopes. Place drains at intervals to handle the accumulated water.
4. Continue temporary erosion control measures until permanent drainage facilities have been constructed, pavement placed, and the grass on planted slopes stabilized to deter erosion.

G. Perform Construction in Rivers and Streams

Perform construction in river and stream beds as follows:

1. Unless otherwise agreed to in writing by the Engineer, restrict construction operations in rivers, streams, and impoundments to:
 - Areas where channel changes or access for construction are shown on the Plans to construct temporary or permanent structures.
2. If channel changes or diversions are not shown on the Plans, the Contractor shall develop diversion plans prepared in accordance with the current GAR100002 NPDES Infrastructure Construction permit utilizing a design professional as defined within the permit. The Engineer will review prepared diversion plans for content only and accepts no responsibility for design errors or omissions. Amendments will be made part of the project plans by attachment. Include any associated costs in the price bid for the overall contract. Any contract time associated with the submittal or its review and subsequent response will not be considered for an extension of Contract time. All time associated with this subsection shall be considered incidental.
3. If additional access for construction or removal of work bridges, temporary roads/access or work platforms is necessary, and will require additional encroachment upon river or stream banks and bottoms, the contractor shall prepare a plan in accordance with the current GAR100002 NPDES Infrastructure Construction permit utilizing a design professional as defined within the permit. Plans should be submitted at least 12 weeks prior to the date the associated work is expected to begin. If necessary, the plan will be provided to the appropriate regulating authority, e.g. United States Army Corps of Engineers by the Department for consideration and approval. No work that impacts areas beyond what has been shown in the approved plans will be allowed to begin until written approval of the submitted plan has been provided by the Department. Approved plan amendments will be made part of the project plans by attachment. Include any associated costs in the price bid for the overall contract. Any contract time associated with the submittal or its review and subsequent response will not be considered for an extension of Contract time. All time associated with this subsection shall be considered incidental.
4. Clear rivers, streams, and impoundments of the following as soon as conditions permit:

- Falsework
 - Piling that is to be removed
 - Debris
 - Other obstructions placed or caused by construction operations
5. Do not ford live streams with construction equipment.
 6. Use temporary bridges or other structures that are adequate for a 25-year storm for stream crossings. Include costs in the price bid for the overall contract.
 7. Do not operate mechanized equipment in live streams except to construct channel changes or temporary or permanent structures, and to remove temporary structures, unless otherwise approved in writing by the Engineer.

H. State Water Buffers and Environmental Restrictions

1. The WECS shall review the plans and contract documents for environmental restrictions, Environmentally Sensitive Areas (ESA), e.g. buffers, etc prior to performing land disturbing activities.
2. The WECS shall ensure all parties performing land disturbing activities within the project limits are aware of all environmental restrictions.
3. Buffer delineation shall be performed prior to clearing, or any other land disturbing activities. Site conditions may require temporary delineation measures are implemented prior to the installation of orange barrier/safety fencing. The means of temporary delineation shall have the Engineer's prior approval.
4. The WECS shall allow the Engineer to review the buffer delineation prior to performing any land disturbing activities, including but not limited to clearing, grubbing and thinning of vegetation. Any removal and relocation of buffer delineation based upon the Engineer's review will not be measured for separate payment.
5. The WECS shall advise the Engineer of any surface water(s) encountered that are not shown in the plans. The WECS shall prevent land disturbing activities from occurring within surface water buffers until the Engineer provides approval to proceed.

I. General Requirements

Projects that consist of asphalt resurfacing, shoulder reconstruction and/or shoulder widening; schedule and perform the construction of the project to comply with the following:

After temporary and permanent erosion control devices are installed and the area permanently stabilized (temporary or permanent) and approved by the Engineer, the area may be released from the 1 acre (0.4 ha) limit.

The maximum of 1 acre (0.4 ha) of erodible earth applies to the entire project and to all combined operations, including borrow and excess material operations that are within the right of way, not 1 acre (0.4 ha) of exposed erodible earth for each operation.

NOTE: Never allow the surface area of erodible earth material exposed at one time to exceed 1 acre (0.4 ha).

1. Do not allow the disturbed exposed erodible area to exceed 1 acres (0.4 ha). This 1 acre (0.4 ha) limit includes all disturbed areas relating to the construction of the project including but not limited to slope and shoulder construction.

2. At the end of each working day, permanently stabilize all of the area disturbed by slope and shoulder reconstruction to prevent any contamination of adjacent streams or other watercourses, lakes, ponds or other areas of water impoundment. For purposes of this Specification, the end of the working day is defined as when the construction operations cease. For example, 6:00 a.m. is the end of the working day on a project that allows work only between 9:00 p.m. and 6:00 a.m.)
3. Stabilize the cut and fill slopes and shoulder with permanent or temporary grassing and a Wood Fiber Blanket ([Section 713](#), Type II). Mulching is not allowed. Borrow pits, soil disposal sites and haul roads will not require daily applications of wood fiber blanket. The application rate for the Wood Fiber Blanket on shoulder reconstruction is the rate specified for Shoulders. For shoulder reconstruction, the ground preparation requirements of [Subsection 700.3.05.A.1](#) are waived. Preparation consists of scarifying the existing shoulders 4 to 6 in (100 to 150 mm) deep and leaving the area in a smooth uniform condition free from stones, lumps, roots or other material.
4. If a sudden rain event occurs that would not allow the Contractor to apply the Type II Wood Fiber Blanket per [Section 713](#), install Wood Fiber Blanket Type I per [Section 713](#) if directed by the Engineer. Wood Fiber Blanket Type I application is for emergency use only.

Install temporary grass or permanent grass according to seasonal limitations and Specifications. When temporary grass is used, use the overseeding method ([Subsection 700.3.05.E.4](#)) when planting permanent grass.

3. Remove and dispose of all material excavated for the trench widening operation at an approved soil disposal site by the end of each working day. When shoulder reconstruction is required, this material may be used to reconstruct the graded shoulder after all asphaltic concrete pavement has been placed.
4. Provide immediate permanent and/or temporary erosion control measures for borrow pits, soil disposal sites and haul roads to prevent any contamination of adjacent streams or other watercourses, lakes, ponds or other areas of water impoundment.
5. Place asphalt in the trench the same day as the excavation occurs. Place asphalt or concrete in driveways and side roads being re-graded the same day as the excavation occurs. Stabilize any disturbed or exposed soil that is not covered with asphalt with a Wood Fiber Blanket (and grass seed). Payment will be made for the Wood Fiber Blanket and grass seed only if the shoulder has been constructed to final dimensions and grade and no further grading will be required.
6. Do not allow the grading (height of cut or fill) to exceed the operating range of the grassing equipment.
7. When grading operations or other soil disturbing activities are suspended, regardless of the reason, promptly perform all necessary permanent stabilization and/or erosion control work.
8. Use temporary erosion control measures to:
 - To correct conditions that develop during construction but were unforeseen during the design stage.
 - To use as needed before installing permanent erosion control features.
 - To temporarily control erosion that develops during normal construction practices but are not associated with permanent control features on the Project.
9. When conditions warrant, such as unfavorable weather (rain event), the Engineer may require more frequent intervals for this work.

161.3.06 Quality Acceptance

Before Final Acceptance of the Work, clean drainage structures within the project limits, both existing and newly constructed, and ensure that they are functioning properly. Costs to accomplish this work are incidental and shall be included in the overall bid for the Contract.

161.3.07 Contractor Warranty and Maintenance

Maintain the erosion control features installed to:

- Contain erosion within the limits of the right-of-way

- Control storm water discharges from disturbed areas

Effectively install and maintain the erosion control features. Ensure these features contain the erosion and sediment within the limits of the rights of way and control the discharges of storm-water from disturbed areas to meet all local, state, and federal requirements on water quality.

If a construction Project has separate contractors, the Prime Contractor shall maintain the erosion control features at grading sites as acceptable to the Engineer until the Contract is accepted. If any erosion control devices are damaged by any contractor either by neglect, by construction methods, or any other reasons, including acts of nature, they shall be repaired within 24 hours by the Prime Contractor at no cost to the Department.

161.4 Measurement

Control of soil erosion and sedimentation is not measured separately for payment.

161.4.01 Limits

General Provisions 101 through 150.

161.5 Payment

The requirements of this Specification and the Erosion Control Plan shall be in full effect. The cost of complying with these requirements will not be paid for separately, but shall be included in the overall bid submitted for CONSTRUCTION COMPLETE.

No payment will be made for erosion control outside the Right-of-Way or construction easements except as provided for by the Plans.

161.5.01 Enforcement and Adjustments

A. Failure to Provide a WECS

If a designated WECS is not maintained or if the Contractor does not comply with this Specification, cease activities except traffic control and erosion control work. Monies that are due or that may become due also may be withheld according to the Specifications

B. Failure to submit reports

A non-refundable deduction will be taken from the schedule below whenever the WECS fails to submit completed reports required by [Subsection 167.3.05.C](#) in accordance with the provisions of this specification.

C. Failure to Comply with Specifications

If the Contractor fails to comply with any of the requirements of this Specification, all activities shall cease immediately except traffic control and erosion control related work.

Monies that are currently due or that may become due shall be withheld according to the specifications. In addition, nonrefundable monies shall be deducted from the contract as shown in the Schedule of Deductions table below. These deductions are in addition to any actions taken in the above subsections. Deductions assessed for uncorrected deficiencies shall continue until all corrections are completed to the satisfaction of the Engineer.

D. Receipt of a Consent Order or Notice of Violation, etc

Regulatory enforcement actions will be resolved including at a minimum the following steps;

- The Department will perform an internal review of the alleged violations
- The Department will then meet with the Contractor to review and further determine responsibilities for the alleged violations

- The Department will then arrange to collectively meet with the regulatory agencies to negotiate resolutions and/or settlements.

The Department does not waive any rights of the Contractor to resolve such matters however, in the event that regulatory agency communication is addressed jointly to the Department and to the contractor, the Department reserves the right to coordinate all communications, e.g., written correspondence, and to schedule jointly attended meetings with Regulatory agencies such that timely and accurate responses are known to the Department.

Such Orders or Notices may result in the assessment of Deductions from the table below for each day the condition remains non-compliant following an agreed remedy.

Monetary penalties for which the contractor is obligated for as a result of regulatory enforcement may be withheld from future monies due the contractor.

Schedule of Deductions for Each Calendar Day of Erosion Control Deficiencies Initial Occurrence* Original Total Contract Amount		
From More Than	To and Including	Daily Charge
0	\$100,000	\$750
\$100,000	\$1,000,000	\$1125
\$1,000,000	\$5,000,000	\$2000
\$5,000,000	\$15,000,000	\$3000
\$15,000,000	-	\$5000

*Continued non-compliance with the requirements of this specification may result in the doubling of the above tabulated Daily Charge.

Upon written request from the Contractor, the Engineer may allow, limited activities to concurrently proceed once significant portions of the corrective work have been completed. This authorization may be similarly rescinded if in the opinion of the Engineer corrective work is not being diligently pursued.

**DEPARTMENT OF TRANSPORTATION
STATE OF GEORGIA**

SPECIAL PROVISION

**Project Number: CSNHS-0008-00(415)
P.I. Number: 0008415
Fulton County**

Section 163—Miscellaneous Erosion Control Items

163.1 General Description

This work includes constructing and removing:

- Silt control gates
- Temporary erosion control slope drains shown on the Plans or as directed
- Sediment basins
- Baled straw sediment barrier and check dams
- Other temporary erosion control structures shown on the Plans or directed by the Engineer

This work also includes applying mulch (straw or hay, erosion control compost), and temporary grass.

163.1.01 Related References

A. Standard Specifications

[Section 109—Measurement and Payment](#)

[Section 161—Control of Soil Erosion and Sedimentation](#)

[Section 171—Temporary Silt Fence](#)

[Section 500—Concrete Structures](#)

[Section 603—Rip Rap](#)

[Section 700—Grassing](#)

[Section 715—Bituminous Treated Roving](#)

[Section 720 – Triangular Silt Barrier](#)

[Section 822—Emulsified Asphalt](#)

[Section 860—Lumber and Timber](#)

[Section 863—Preservative Treatment of Timber Products](#)

[Section 890—Seed and Sod](#)

[Section 893—Miscellaneous Planting Materials](#)

B. Referenced Documents

AASHTO M252

AASHTO M294

163.1.02 Submittals

Provide written documentation to the Engineer as to the average weight of the bales of mulch.

163.2 Materials

Provide materials shown on the Plans, such as pipe, spillways, wood baffles, and other accessories including an anti-seep collar, when necessary. The materials shall remain the Contractor’s property after removal, unless otherwise shown on the Plans.

Materials may be new or used; however, the Engineer shall approve previously used materials before use.

Materials shall meet the requirements of the following Specifications:

Material	Section
Mulch	893.2.02
Temporary Silt Fence	171
Concrete Aprons and Footings shall be Class A	500
Rip Rap	603
Temporary Grass	700
Bituminous Treated Roving	715
Triangular Silt Barrier	720
Lumber and Timber	860.2.01
Preservative Treatment of Timber Products	863.1
Corrugated Polyethylene Temporary Slope Drain Pipe	AASHTO M252 or M294

163.2.01 Delivery, Storage, and Handling

General Provisions 101 through 150.

163.3 Construction Requirements

163.3.01 Personnel

General Provisions 101 through 150.

163.3.02 Equipment

General Provisions 101 through 150.

163.3.03 Preparation

General Provisions 101 through 150.

163.3.04 Fabrication

General Provisions 101 through 150.

163.3.05 Construction

A. Silt Control Gates

If silt control gates are required or are directed by the Engineer, follow these guidelines to construct them:

1. Clear and grade only that portion of the roadway within the affected drainage area where the drainage structure will be constructed.
2. Construct or install the drainage structure and backfill as required for stability.
3. Install the silt control gate at the inlet of the structure. Use the type indicated on the Plans.
4. Vary the height of the gate as required or as shown on the Plans.
5. Finish grading the roadway in the affected drainage area. Grass and mulch slopes and ditches that will not be paved. Construct the ditch paving required in the affected area.
6. Keep the gate in place until the work in the affected drainage area is complete and the erodible area is stabilized.
7. Remove the Type 1 silt gate assembly by sawing off the wood posts flush with the concrete apron. Leave the concrete apron between the gate and the structure inlet in place. The gate shall remain the property of the Contractor.

B. Temporary Slope Drains

If temporary slope drains are required, conduct the roadway grading operation according to [Section 161](#) and follow these guidelines:

1. Place temporary pipe slope drains with inlets and velocity dissipaters (straw bales, silt fence, or aprons) according to the Plans.
2. Securely anchor the inlet into the slope to provide a watertight connection to the earth berm. Ensure that all connections in the pipe are leak proof.
3. Place temporary slope drains at a spacing of 350 ft (105 m) maximum on a 0% to 2% grade and at a spacing of 200 ft (60m) maximum on steeper grades, or more frequently as directed by the Engineer. Keep the slope drains in place until the permanent grass has grown enough to control erosion.
4. Remove the slope drains and grass the disturbed area with permanent grass. However, the temporary slope drains may remain in place to help establish permanent grass if approved by the Engineer.

C. Sediment Basins

Construct sediment basins according to the Plans at the required location, or as modified by the Engineer.

1. Construct the unit complete as shown, including:
 - Grading
 - Drainage
 - Rip rap
 - Spillways
 - Anti-seep collar
 - Temporary mulching and grassing on internal and external slopes
 - Accessories to complete the basin
2. When the sediment basin is no longer needed, remove and dispose of the remaining sediment.
3. Remove the sediment basin. Grade to drain and restore the area to blend with the adjacent landscape.
4. Mulch and permanently grass the disturbed areas according to [Section 700](#).

D. Sediment Barrier (baled straw)

Construct sediment barrier (baled straw) according to the Plan details. Use rectangular, standard size baled straw in mechanically produced bales.

The following items may be substituted for sediment barrier (baled straw)

1. Type B Silt Fence.

2. Triangular Silt Barrier.
3. Synthetic Fiber: Use synthetic fiber bales of circular cross section at least 18 in (450 mm) in diameter. Use synthetic bales of 3 ft or 6 ft (0.9 m or 1.8 m) in length that are capable of being linked together to form a continuous roll of the desired total length. Use bales that are enclosed in a geotextile fabric and that contain a pre-made stake hole for anchoring.
4. Coir: Use coir fiber bales of circular cross section at least 16" (400mm) in diameter. Use coir bales of 10 ft, 15 ft, or 20 ft (3 m, 4.5 m, or 6 m) in length. Use coir baled with coir twine netting with 2 in X 2 in (50 mm X 50 mm) openings. Use coir bales with a dry density of at least 7 lb/ft³ (112 kg/m³). Anchor in place with 2 in X 4 in (50 mm X 100 mm) wooden wedges with a 6 in (150 mm) nail at the top. Place wedges no more than 36 in (900 mm) apart.
5. Excelsior: Use curled aspen excelsior fiber with barbed edges in circular bales of at least 18 in (450 mm) in diameter and nominally 10 ft (3 m) in length. Use excelsior baled with polyester netting with 1 in X 1 in (25 mm by 25 mm) triangular openings. Use excelsior bales with a dry density of at least 1.4 lb/ft³ (22 kg/m³). Anchor in place with 1 in (25 mm) diameter wooden stakes driven through the netting at intervals of no more than 2 ft (600 mm).
6. Compost Filter Sock: Use general use compost (see [Subsection 893.2.02.A.5.b](#)) in circular bales at least 18 in in diameter. Use compost baled with photo-degradable plastic mesh 3 mils thick with a maximum 0.25 in X 0.25 in (6 mm X 6 mm) openings. Anchor in place with 1 in (25 mm) diameter wooden stakes driven through the netting at intervals of no more than 2 ft (600 mm). The sock shall be dispersed on site when no longer required, as determined by the Engineer. Do not use Compost Filter Socks in areas where the use of fertilizer is restricted.
7. Compost Filter Berm: Use erosion control compost (see [Subsection 893.2.02](#)) to construct an uncompacted 1.5 ft to 2 ft (450 mm to 600 mm) high trapezoidal berm which is approximately 2 ft to 3 ft (600 mm to 1 m) wide at the top and minimum 4 ft (1.2 m) wide at the base. Do not use Compost Filter Berms in areas where the use of fertilizer is restricted.

The construction of the compost filter berm includes the following:

- a. Keeping the berm in a functional condition.
- b. Installing additional berm material when necessary.
- c. Removing the berm when no longer required, as determined by the Engineer. At the Engineer's discretion, berm material may be left to decompose naturally, or distributed over the adjacent area.

E. Other Temporary Structures

When special conditions occur during the design stage, the Plans may show other temporary structures for erosion control with required materials and construction methods.

F. Temporary Grass

Use a quick growing species of temporary grass such as rye grass, millet, or a cereal grass suitable to the area and season.

Use temporary grass in the following situations:

- When required by the Specifications or directed by the Engineer to control erosion where permanent grassing cannot be planted.
- To protect an area for longer than mulch is expected to last (60 calendar days).

Plant temporary grass as follows:

1. Use seeds that conform to [Subsection 890.2.01, "Seed."](#) Perform seeding according to [Section 700](#); except use the minimum ground preparation necessary to provide a seed bed if further grading is required.

2. Prepare areas that require no further grading according to [Subsection 700.3.05.A, "Ground Preparation."](#) Omit the lime unless the area will be planted with permanent grass without further grading. In this case, apply the lime according to [Section 700](#).
3. Apply mixed grade fertilizer at 400 lbs/acre (450 kg/ha). Omit the nitrogen. Mulch (with straw or hay) temporary grass according to [Section 700](#). (Erosion control compost Mulch will not be allowed with grassing.)
4. Before planting permanent grass, thoroughly plow and prepare areas where temporary grass has been planted according to [Subsection 700.3.05.A, "Ground Preparation"](#).
5. Apply Polyacrylamide (PAM) to all areas that receive temporary grassing.
6. Apply Pam (powder) before grassing or PAM (emulsion) to the hydroseeding operation.
7. Apply PAM according to manufacturer specifications.
8. Use only anionic PAM.

For projects that consist of shoulder reconstruction and/or shoulder widening refer to Section 161.3.05H for Wood Fiber Blanket requirements.

G. Mulch

When stage construction or other conditions prevent completing a roadway section continuously, apply mulch (straw or hay or erosion control compost) to control erosion. Mulch may be used without temporary grassing for 60 calendar days or less. Areas stabilized with only mulch (straw/hay/compost) shall be planted with temporary grass after 60 calendar days.

Apply mulch as follows:

1. Mulch (Hay or Straw)
 - a. Uniformly spread the mulch over the designated areas from 2 in to 4 in (50 mm to 100 mm) thick.
 - b. After spreading the mulch, walk in the mulch by using a tracked vehicle (preferred method), empty sheep foot roller, light discing, or other means that preserves the finished cross section of the prepared areas. The Engineer will approve of the method.
 - c. Place temporary mulch on slopes as steep as 2:1 by using a tracked vehicle to imbed the mulch into the slope. Where specified, use bituminous treated mulch (straw or hay) according to [Subsection 700.3.05.G.1, "Mulch with Binder"](#).
 - d. When grassing operations begin, leave the mulch in place and plow the mulch into the soil during seed bed preparation. The mulch will become beneficial plant food for the newly planted grass.
2. Apply mulch (erosion control compost) as follows:
 - a. Uniformly spread the mulch (erosion control compost) over the designated areas 2 in (50 mm) thick.
 - b. When rolling is necessary, or directed by the Engineer, use a light corrugated drum roller.
 - c. When grassing operations begin, leave the mulch in place and plow the mulch into the soil during seed bed preparation. The mulch will become beneficial plant food for the newly planted grass.
 - d. Plant temporary grass on area stabilized with mulch (erosion control compost) after 60 calendar days.
 - e. Do not use Erosion Control Compost in areas where the use of fertilizer is restricted.

H. Miscellaneous Erosion Control Not Shown on the Plans

When conditions develop during construction that were unforeseen in the design stage, the Engineer may direct the Contractor to construct temporary devices such as but not limited to:

- Bulkheads
- Sump holes
- Half round pipe for use as ditch liners
- U-V resistant plastic sheets to cover critical cut slopes

The Engineer and the Contractor will determine the placement to ensure erosion control in the affected area.

I. Diversion Channels

When constructing a culvert or other drainage structure in a live stream that requires diverting a stream, construct a diversion channel.

J. Temporary Check Dams

Temporary check dams are constructed of the following materials;

- Stone plain rip rap according to [Section 603](#) or of sand bags as in [Section 603](#) without Portland cement. (Place plastic filter fabric on ditch section before placing rip rap.)
- Fabric (Type C silt fence)
- Hay Bales

Temporary check dams shall be constructed according to plan details and shall remain in place until the permanent ditch protection is in place or being installed and the removal is approved by the Engineer.

K. Construction Exits

Locate construction exits at any point where vehicles will be leaving the project onto a public roadway. Install construction exits at the locations shown in the plans and in accordance with plan details.

L. Retrofit

Add the retrofit device to the permanent outlet structure as shown on the Plan details.

When all land disturbing activities that would contribute sediment-laden runoff to the basin are complete, clean the basin of sediment and stabilize the basin area with vegetation.

When the basin is stabilized, remove the retrofit device from the permanent outlet structure of the detention pond.

M. Inlet Sediment Trap

Inlet sediment traps consist of a temporary device placed around a storm drain inlet to trap sediment. An excavated area adjacent to the sediment trap will provide additional sediment storage.

Inlet sediment traps may be constructed of Type C silt fence, plastic frame and filter, hay bales, baffle box, or other filtering materials approved by the Engineer.

Construct inlet sediment traps according to the appropriate specification for the material selected for the trap.

Place inlet sediment traps as shown on the Plans or as directed by the Engineer.

163.3.06 Quality Acceptance

General Provisions 101 through 150.

163.3.07 Contractor Warranty and Maintenance

General Provisions 101 through 150.

163.4 Measurement

A. Silt Control Gates

No separate measurement will be made.

B. Temporary Slope Drains

No separate measurement will be made. When required, the inlet spillway and outlet apron and/or other dissipation devices are incidental and not measured separately.

C. Sediment Basins

No separate measurement will be made for sediment basins which includes but is not limited to, construction, maintenance, and removal, as well as earthwork, drainage, spillways, baffles, rip rap, final cleaning to remove the basin. Permanent and temporary grassing for sediment basins is not measured separately for payment.

D. Diversion Channels

Diversion channels are not measured for payment. Costs for the entire structure complete, including materials, construction (including earthwork), and removal is included in the price bid for the CONSTRUCTION COMPLETE.

E. Temporary Grass

No separate measurement will be made. Temporary grass includes mulch and fertilizer.

F. Mulch

No separate measurement will be made.

G. Baled Straw Sediment Barrier, Baled Straw Check Dam and Fabric Check Dams

No separate measurement will be made for baled straw sediment barrier, baled straw check dams, and fabric check dams. When the Contractor substitutes a product allowed in [Subsection 163.3.05.D](#) for baled straw sediment barrier or when the Engineer directs this substitution, no separate measure will be made for the product.

H. Rip Rap Check Dams

No separate measurement will be made.

I. Construction Exits

No separate measurement will be made.

J. Retrofit

No separate measurement will be made.

K. Inlet Sediment Trap

No separate measurement will be made.

163.4.01 Limits

General Provisions 101 through 150.

163.5 Payment

A. Silt Control Gates

To be paid for under CONSTRUCTION COMPLETE. Includes:

- Furnishing the material and labor
- Constructing the concrete apron as shown on the Plans
- Excavating and backfilling to place the apron
- Removing the gate

B. Temporary Slope Drains

To be paid for under CONSTRUCTION COMPLETE. Includes materials, construction, removal (if required), inlet spillways, velocity dissipaters, and outlet aprons.

When temporary drain inlets and pipe slope drains are removed, they remain the Contractor's property and may be reused or removed from the Project as the Contractor desires. Reused pipe or inlets are paid for the same as new pipe or inlets.

C. Sediment Basin

To be paid for under CONSTRUCTION COMPLETE. Includes work and supervision to construct, and remove the sediment basin, including final clean-up.

D. Diversion Channel

Diversion channels are not paid for separately; they are included in the price bid CONSTRUCTION COMPLETE.

E. Temporary Grass

To be paid for under CONSTRUCTION COMPLETE. Includes all equipment, labor, ground preparation, materials, wood fiber mulch, polyacrylamide, and other incidentals. Lime (when required) is paid for by the ton (megagram). Mulch and fertilizer are paid for separately.

F. Mulch

To be paid for under CONSTRUCTION COMPLETE. Includes all materials, labor, maintenance, equipment and other incidentals.

G. Baled Straw Sediment barrier, Baled Straw Check Dams and Fabric Check Dams (Type C Silt Fence)

To be paid for under CONSTRUCTION COMPLETE. Includes constructing, and removing (when directed) the baled straw sediment barrier or either check dam.

When the Contractor substitutes any product allowed in [Subsection 163.3.05.D](#) for baled straw sediment barrier or when the Engineer directs this substitution, payment is also made at the bid price CONSTRUCTION COMPLETE.

H. Rip Rap Check Dams

To be paid for under CONSTRUCTION COMPLETE. Includes all materials, construction, and removal. Reused stone plain rip rap or sandbags are paid for on the same basis as new items. Filter fabric required under rip rap check dams is included in the price bid for each check dam.

I. Construction Exits

To be paid for under CONSTRUCTION COMPLETE. Includes all materials including the required geotextile, construction, and removal.

J. Retrofit

To be paid for under CONSTRUCTION COMPLETE. Includes all work, supervision, materials (including the stone filter), labor and equipment necessary to construct and remove the retrofit device from an existing or proposed detention pond outlet structure.

K. Inlet Sediment Trap

To be paid for under CONSTRUCTION COMPLETE. Includes all materials, construction, and removal

163.5.01 Adjustments

General Provisions 101 through 150.

**DEPARTMENT OF TRANSPORTATION
STATE OF GEORGIA**

SPECIAL PROVISION

Project Number: CSNHS-0008-00(415)

P.I. Number: 0008415

Fulton County

**Section 165—Maintenance of Temporary Erosion and Sedimentation Control
Devices**

165.1 General Description

This work consists of providing maintenance on temporary erosion and sediment control devices, including but not limited to the following:

- Silt fence
- Sediment basins
- Silt control gates
- Check dams
- Silt retention barriers

It also consists of removing sediment that has accumulated at the temporary erosion and sediment control devices.

165.1.01 Definitions

General Provisions 101 through 150.

165.1.02 Related References

A. Standard Specifications

General Provisions 101 through 150.

B. Referenced Documents

General Provisions 101 through 150.

165.1.03 Submittals

General Provisions 101 through 150

165.2 Materials

General Provisions 101 through 150.

165.2.01 Delivery, Storage, and Handling

General Provisions 101 through 150.

165.3 Construction Requirements

165.3.01 Personnel

General Provisions 101 through 150.

165.3.02 Equipment

General Provisions 101 through 150.

165.3.03 Preparation

General Provisions 101 through 150.

165.3.04 Fabrication

General Provisions 101 through 150.

165.3.05 Construction

A. General

As a minimum, clean the sediment from all temporary erosion control devices (except sediment basins) installed on the project when one half the capacity, by height, depth or volume has been reached. Clean the sediment from all temporary sediment basins installed on a project when one third the capacity of the storage volume has been filled.

Handle sediment excavated from any erosion or sediment control device in one of the following ways:

- Remove sediment from the immediate area and immediately stabilize it to prevent the material from refilling any erosion or sediment control device.
- Place and mix it in the roadway embankment, or waste it in an area approved by the Engineer.
- Repair or replace at no cost to the Department, any erosion or sediment control devices that are not functioning properly or are damaged due to negligence or abuse.

B. Temporary Silt Fence

Maintenance of Temporary Silt Fence consists of furnishing all labor, tools, materials, equipment and necessary incidentals to remove and dispose of accumulated sediment down to the original ground line (0 % filled). Also included is the removal of sediment accumulations (“filtercake”) on the fabric by tapping the fabric on the downstream side.

C. Silt Control Gates

Maintenance of Temporary Silt Control Gates consists of all labor, tools, materials, equipment and necessary incidentals to remove and dispose of accumulated sediment down to the original ground line (0% filled). When applicable, this item will include the removal of sediment accumulations on the fabric by tapping the fabric on the downstream side.

D. Check Dams (all types)

Maintenance of Temporary Erosion Control Check Dams shall consist of all labor, tools, materials, equipment and necessary incidentals to remove and dispose of accumulated sediment down to the original ground line (0% filled). This item also includes the removal of any material deposited in sump holes. When applicable, this item will include the removal of sediment accumulations on the fabric by tapping the fabric on the downstream side, or from the baled straw by similar means.

E. Silt Retention Barrier

Maintenance of Temporary Silt Retention Barrier consists of all labor, tools, materials, equipment and necessary incidentals to remove and dispose of accumulated sediment down to the original ground line (0% filled).

F. Temporary Sediment Basins

Maintenance of Temporary Sediment Basins consists of all labor, tools, materials, equipment and necessary incidentals to remove and dispose of accumulated sediment down to the original bottom of the basin. This also includes removing accumulated sediment from the rock filter and restoring the rock filter to its original specified condition and any work necessary to restore all other components to the pre-maintenance conditions.

G. Sediment Barrier (baled straw)

Maintenance of sediment barrier (baled straw) consists of furnishing all labor, tools, materials, equipment and necessary incidentals to remove and dispose of accumulated sediment down to the original ground line (0 % filled). Also included is the removal of sediment accumulations on the bales by tapping.

H. Triangular Silt Barrier

Maintenance of Triangular Silt Barrier consists of all labor, tools, materials, equipment and necessary incidentals to remove and dispose of accumulated sediment down to the original ground line (0% filled).

I. Retrofit:

Maintenance of the retrofit device consists of all labor, tools, materials, equipment and necessary incidentals to remove and properly dispose of accumulated sediment in the permanent detention pond being utilized as a temporary sediment basin. This item also includes any maintenance that is required to ensure the retrofit device is maintained per Plan details and any maintenance of the stone filter to maintain its filtering ability, including cleaning and replacement.

J. Construction Exit:

Maintenance of the construction exit consists of all labor, tools, materials, equipment and incidentals, including additional stone and geotextile fabric as required to prevent the tracking or flow of soil onto public roadways. This includes, scarifying existing stone, cleaning existing stone, or placement of additional stone.

Cleaning of the construction exit by scraping and/or brooming only will not be measured for payment.

K. Inlet Sediment Trap

Maintenance of inlet sediment traps consists of all labor, tools, materials, equipment and necessary incidentals to remove and properly dispose of accumulated sediment in the trap and/or the excavated area adjacent to the trap. It also includes any maintenance that is required to remove sediment accumulations (“filtercake”) from the material selected to construct the inlet sediment trap.

165.3.06 Quality Acceptance

General Provisions 101 through 150.

165.3.07 Contractor Warranty and Maintenance

General Provisions 101 through 150.

165.4 Measurement

A. Temporary Silt Fence:

No separate measurement will be made.

B. Silt Control Gates:

No separate measurement will be made.

C. Check Dams (All Types):

No separate measurement will be made.

D. Silt Retention Barrier:

No separate measurement will be made.

E. Temporary Sediment Basins:

No separate measurement will be made.

F. Sediment Barrier (baled straw)

No separate measurement will be made.

F. Triangular Silt Barrier:

No separate measurement will be made.

G. Retrofit:

No separate measurement will be made.

H. Construction Exit:

No separate measurement will be made.

I. Inlet Sediment Trap

No separate measurement will be made.

165.4.01 Limits

General Provisions 101 through 150.

165.5 Payment

A. Temporary Silt Fence:

To be paid for under CONSTRUCTION COMPLETE.

B. Silt Control Gates:

To be paid for under CONSTRUCTION COMPLETE.

C. Check Dams (All Types):

To be paid for under CONSTRUCTION COMPLETE.

D. Silt Retention Barrier:

To be paid for under CONSTRUCTION COMPLETE.

E. Temporary Sediment Basins:

To be paid for under CONSTRUCTION COMPLETE.

F. Sediment Barrier (baled straw):

To be paid for under CONSTRUCTION COMPLETE.

G. Triangular Silt Barrier:

To be paid for under CONSTRUCTION COMPLETE.

H. Retrofit:

To be paid for under CONSTRUCTION COMPLETE.

I. Construction Exit:

To be paid for under CONSTRUCTION COMPLETE.

J. Inlet Sediment Trap

To be paid for under CONSTRUCTION COMPLETE.

165.5.01 Adjustments

General Provisions 101 through 150.

Date: August 26, 2002
First Use Date 2001 Specifications: November 1, 2002
Revised: January 16, 2003
Revised: August 1, 2003
Revised: February 1, 2004
Revised October 15, 2005
Revised July 15, 2008

**DEPARTMENT OF TRANSPORTATION
STATE OF GEORGIA**

SPECIAL PROVISION

**Project Number: CSNHS-0008-00(415)
P.I. Number: 0008415
Fulton County**

Section 167—Water Quality Monitoring

Add the following:

167.1 General Description

This Specification establishes the Contractor's responsibility to meet the requirements of the National Pollutant Discharge Elimination System (NPDES) Infrastructure Permit No. GAR 100002 as it pertains to Part IV. Erosion, Sedimentation and Pollution Control Plan.

167.1.01 Definitions

Certified Personnel— certified personnel are defined as persons who have successfully completed the appropriate certification course approved by the Georgia Soil and Water Conservation Commission. For Department projects the certified person must also have successfully completed the Department's WECS certification course.

167.1.02 Related References

A. Standard Specifications

[Section 161—Control of Soil Erosion and Sedimentation](#)

B. Referenced Documents

NPDES Infrastructure Permit No. GAR 100002, Part IV

GDOT WECS seminar.

Environmental Protection Divisions Rules and Regulations (Chapter 391-3-26)

Georgia Soil and Water Conservation Commission Certification Level IA course.

OCGA 12-7

167.1.03 Submittals

General Provisions 101 through 150

167.2 Materials

General Provisions 101 through 150.

167.2.01 Delivery, Storage, and Handling

General Provisions 101 through 150.

167.3 Construction Requirements

167.3.01 Personnel

Use certified personnel to perform all monitoring, sampling, inspections, and rainfall data collection.

Use the Contractor designated WECS or select a prequalified consultant from the Qualified Consultant List (QCL) to perform water quality monitoring.

Ensure that monitoring consultants' employees who perform monitoring, sampling, inspections, and rainfall data collection are GASWCC Certified.

167.3.02 Equipment

Provide equipment necessary to complete the Work or as directed.

167.3.03 Preparation

General Provisions 101 through 150.

167.3.04 Fabrication

General Provisions 101 through 150.

167.3.05 Construction

A. General

Perform inspections, rainfall data collection, testing of samples, and reporting the test results on the project according to the requirements in Part IV of the NPDES Infrastructure permit and this Specification.

Take samples manually or with the use of automatic samplers, according to the permit. Analyze all according to the permit, regardless of the method used to collect the samples.

If samples are analyzed in the field using portable turbidimeters, the monitoring results shall state that they are being used and a digital readout of NTUs is what is provided.

Submit bench sheets, work sheets, etc., when using portable turbidimeters. There are no exceptions to this requirement.

Perform required inspections and submit all reports required by this Specification within the time frames specified. Failure to perform the inspections within the time specified will result in the cessation of all construction activities with the exception of traffic control and erosion control. Failure to submit the required reports within the times specified will result in non-refundable deductions as specified in [Subsection 161.5.01.B](#).

B. Inspections

The Department will provide one copy of required inspection forms for use and duplication. Inspection forms may change during the contract to reflect regulatory agency needs or the need of the Department. Any costs associated with the change of inspection forms shall be considered incidental. Alternate formats of the provided forms maybe created, used and submitted by the Contractor provided the required content and/or data fields and verbatim certification statements from the Department's current forms are included.

The Engineer shall inspect the installation and condition of each erosion control device required by the erosion control plan within seven days after initial installation. This inspection is performed for each stage of construction when new devices are installed. The WECS shall ensure all installation deficiencies reported by the Engineer are corrected within two business days.

Ensure that the inspections of the areas listed below are conducted by certified personnel and at the frequencies listed. Document all inspections on the appropriate form provided by the Department.

1. Daily:

- a. Petroleum product storage, usage and handling areas
- b. All locations where vehicles enter/exit the site

Continue these inspections until all entry and exit sites are stabilized and fuel is not stored or transferred on the site. Utilize the Daily inspection form.

2. Weekly and after Rainfall Events:

Conduct inspections on these areas every seven calendar days and within twenty-four hours after the end of a rainfall event that is 0.5 in (13 mm) or greater:

- a. Disturbed areas not permanently stabilized
- b. Material storage areas
- c. Structural control measures, Best Management Practices (BMPs)
- d. Water quality monitoring locations and equipment

Continue these inspections until all BMPs have been removed. Utilize the EC-1 Form.

3. Monthly:

Once per month, inspect all areas where final stabilization has been completed. Look for evidence of sediments or pollutants entering the drainage system and or receiving waters. Inspect all permanent erosion control devices that remain in place to verify the maintenance status and that the devices are functioning properly.

Continue these inspections until the Notice of Termination is submitted. Utilize the Monthly inspection form.

C. Reports:

1. Inspection Reports:

Summarize the results of inspections noted above in writing on the appropriate Daily, Weekly, Monthly or EC-1 form provided by the Department. Include the following information:

- Date(s) of inspection
- Name of personnel performing inspection
- Status of devices
- Observations
- Action taken
- Signature of personnel performing the inspection
- Any incidents of non-compliance

The inspection form certification sheet shall be signed by the project WECS and the inspector performing inspections on behalf of the WECS (if not the same person).

Submit all inspection reports to the Engineer within twenty-four hours of the inspection.

The Engineer will review the submitted reports and inspect the project to determine their accuracy.

The Engineer will notify the certified personnel of any additional items that should be added to the inspection report.

Correct any items listed in the inspection report requiring routine maintenance within 72 (seventy-two) hours of notification.

Assume responsibility for all costs associated with additional sampling as specified in Part IV.D.6.d.3.(c) of the NPDES GAR 100002 permit if either of these conditions arise:

- BMPs shown in the Plans are not properly installed and maintained, or
- BMPs designed by the Contractor are not properly designed, installed and maintained.

2. Monitoring Reports

a. Report Requirements

Include in all reports, the following certification statement, signed by the WECS or consultant providing monitoring on the project:

“I certify under penalty of law that this document and all attachments were prepared under my direct supervision in accordance with a system designed to assure that certified personnel properly gather and evaluate the information submitted. Based on my inquiry of the person or persons who manage the system, or those persons directly responsible for gathering the information, the information is, to the best of my knowledge and belief,

true, accurate and complete. I am aware that there are significant penalties for submitting false information, including the possibility of fine and imprisonment for knowing violations.”

When a rainfall event requires a sample to be taken, submit a report of the monitoring results to the Engineer within seven working days of the date the sample was obtained. Include the following information:

- 1) Date of sampling
- 2) Rainfall amount on sample date (sample date only)
- 3) NTU of sample & analysis method
- 4) Location where sample was taken (station number, etc.)
- 5) Receiving water or outfall sample
- 6) Project number and county
- 7) Whether the sample was taken by automatic sampler or manually (grab sample)

b. Report Requirements with No Qualifying Rainfall Events

In the event that a qualifying rainfall event does not occur prior to the submittal of the NOT (Notice of Termination), submit a report that states “No qualifying rainfall event occurred and no samples were taken.”

c. Test Results

Provide monitoring test results to the Engineer within 48 hours of the samples being analyzed. This notification may be verbal or written. This notification does not replace the requirement to submit the formal monitoring summary to the Engineer within 7 working days of the samples being collected.

3. Rainfall Data Reports

Record the measurement of rainfall once each twenty-four hour period. Measure rainfall data at the active phase of construction on the site.

Project rain gauges and those used to trigger the automatic samplers are to be emptied after every rainfall event. This will prevent a cumulative effect and prevent automatic samplers from taking samples even though the rainfall event was not a qualifying event.

The daily rainfall data supplied by the WECS to the Engineer will be the official rainfall data for the project.

167.3.06 Quality Acceptance

General Provisions 101 through 150.

167.3.07 Contractor Warranty and Maintenance

General Provisions 101 through 150.

167.4 Measurement

Water Quality Inspections in accordance with the inspection and reports sub-sections will not be measured separately for payment up to the time the Contract Time expires. Required inspections and reports after Contract Time has expired will not be measured for payment.

Water Quality Monitoring and Sampling are not measured separately for payment.

167.4.01 Limits

General Provisions 101 through 150. Submit the monitoring summary report to the Engineer within 7 working days

167.5 Payment

Payment for Water Quality Monitoring and Sampling will be paid for under CONSTRUCTION COMPLETE.

Water Quality Monitoring and Sampling shall include meeting the requirements of the monitoring sections of the NPDES permit and this Specification, obtaining samples, analyzing samples, any and all necessary incidentals, and providing results of turbidity tests to the Engineer, within the time frame required by the NPDES Infrastructure permit, and this Specification.

This item is based on the rainfall events that require sampling as described in Part IV.D.5 of the permit.

The Department will not pay for samples taken and analyzed for rainfall events that are not qualifying events as compared to the daily rainfall data supplied by the WECS.

Water Quality Inspections will be paid for under CONSTRUCTION COMPLETE. This shall include performing the requirements of the inspection section of the NPDES permit and this Specification, any and all necessary incidentals, and providing results of inspections to the Engineer, within the time frame required by the NPDES Infrastructure permit, and this Specification.

167.5.01 Adjustments

General Provisions 101 through 150.

DEPARTMENT OF TRANSPORTATION
STATE OF GEORGIA
SPECIAL PROVISION

Project Number: CSNHS-0008-00(415)
P.I. Number: 0008415
Fulton County

Section 170—Silt Retention Barrier

Delete Subsection 170.3.05 and substitute the following:

170.3.05 Construction

Install a silt retention barrier as follows: Barriers shall be either staked or floating depending upon current, tides, water depth, and other variables, or as shown in the plans and contract.

A. Floating Silt Retention Barrier

1. Confine dredged materials to ponding areas or settlement basins using standpipes or weirs.
2. Place the barrier approximately 25 ft (7.5 m) outside the affected construction area, and at a depth within 5 ft (1.5 m) of the bottom.
3. If the body of water has a significant current, place the barrier parallel to the water flow.
4. Vary the dimensions and methods to suit the conditions and to meet the requirements of other local and State water control agencies to ensure that silt dispersion is effectively controlled.
5. Provide a fabric that is weighted to prevent the bottom from floating.

B. Staked Silt Retention Barrier

1. Where a staked barrier is used to protect a stream or inundated area, ensure the fabric:
 - a. Extends to the bottom of the stream or inundated area and is weighted to prevent it from floating
 - b. Is not trenched in at the bottom
 - c. Extends 1 foot (300 mm) above normal water

2. Posts:
 - a. Options: 2 inch(50 mm) x 4 inch (100 mm) wood; or 2 ½ inch (62.5 mm min. diameter) wood; or steel at a minimum of 1.33 pounds per foot (1.980 kg/m)
 - b. space posts at a maximum spacing of 4 feet (1.2 m)
 - c. posts are minimum of 5 feet (1.5 m) in length
 - d. posts extend a minimum of 18 inches (450 mm) into the soil

November 2, 2007
December 14, 2007
Revision Date: May 12, 2008
First Use Date: August 22, 2008

**DEPARTMENT OF TRANSPORTATION
STATE OF GEORGIA**

**SPECIAL PROVISION
Project Number: CSNHS-0008-00(415)
P.I. Number: 0008415
Fulton County**

Section 171—Silt Fence

Delete Section 171 and substitute the following:

171.1 General Description

This work includes furnishing, installing, and removing a water permeable filter fabric fence to remove suspended particles from drainage water.

171.1.01 Definitions

General Provisions 101 through 150.

171.1.02 Related References

A. Standard Specifications

[Section 163—Miscellaneous Erosion Control Items](#)

[Section 700—Grassing](#)

[Section 862—Wood Posts and Bracing](#)

[Section 881—Fabrics](#)

[Section 894—Fencing](#)

B. Referenced Documents

ASTM D 3786

ASTM D 4355

ASTM D 4632

ASTM D 4751

[GDT 87](#)

[QPL 36](#)

171.1.03 Submittals

General Provisions 101 through 150.

171.2 Materials

Materials shall meet the requirements of the following Specifications:

Material	Section
Filter Fabrics	881
Fencing	894
Wood Posts and Bracing	862

Conditions during Project construction will affect the quantity of the silt fence to be installed.

The Engineer may increase, decrease, or eliminate the quantity at his or her direction. Variations in quantity are not changes in details of construction or in the character of the work.

For Type A, B, and C fences, use fabric as specified in [Subsection 881.2.07, "Silt Fence Filter Fabric."](#)

171.2.01 Delivery, Storage, and Handling

During shipment and storage, wrap the fabric in a heavy-duty covering that will protect the cloth from sunlight, mud, dust, dirt, and debris. Do not expose the fabric to temperatures greater than 140 °F (60 °C).

When installed, the Engineer will reject the fabric if it has defects, rips, holes, flaws, deterioration, or damage incurred during manufacture, transportation, or storage.

171.3 Construction Requirements

171.3.01 Personnel

General Provisions 101 through 150.

171.3.02 Equipment

General Provisions 101 through 150.

171.3.03 Preparation

General Provisions 101 through 150.

171.3.04 Fabrication

General Provisions 101 through 150.

171.3.05 Construction

Install the silt fence according to this Specification, as shown on the Plans, or as directed by the Engineer as; perimeter, ditch check or similar protection.

A. Install Silt Fence

Install silt fence by either of the following methods:

1. Excavated Trench Method
 - a. Excavate a trench 4 to 6 in (100 to 150 mm) deep using equipment such as a trenching machine or motor grader. If equipment cannot be operated on the site, excavate the trench by hand.
2. Soil Slicing Method
 - a. Create a mechanical slice in the soil 8 to 12 in (200 to 300 mm) deep to receive the silt fence. Ensure that the width of the slice is not more than 3 in (75 mm). Mechanically insert the silt fence fabric into the slice in a simultaneous operation with the slicing that ensures consistent depth and placement.

Install the first post at the center of the low point (if applicable). Space the remaining posts a maximum of 6 ft (1.8 m) apart for Types A and B fence and 4 ft (1.2 m) apart for Type C fence.

Bury the posts at least 18 in (450 mm) into the ground. If this depth cannot be attained, secure the posts enough to prevent the fence from overturning from sediment loading.

Attach the filter fabric to the post using wire, cord, staples, nails, pockets, or other acceptable means.

- a. Staples and Nails (Wood Posts): Evenly space staples or nails with at least five per post for Type A fence and four per post for Type B fence.
- b. Pockets: If using pockets and they are not closed at the top, attach the fabric to a wood post using at least one additional staple or nail, or to a steel post using wire. Ensure that the additional attachment is within the top 6 in (150 mm) of the fabric.

Install the filter fabric so that 6 to 8 in (150 to 200 mm) of fabric is left at the bottom to be buried. Provide a minimum overlap of 18 in (450 mm) at all splice joints.

For Type C fence:

1. Woven Wire Supported
 - a. Steel Post: Use wire to attach the fabric to the top of the woven wire support fence at the midpoint between posts. Also, use wire to attach the fabric to the post.
2. Polypropylene Mesh Supported
 - a. Wood Post: Use at least six staples per post. Use two staples in a crisscross or parallel pattern to secure the top portion of the fence. Evenly space the remaining staples down the post.
 - b. Steel Post: Use wire to attach the fabric and polypropylene mesh to the post.

Install the fabric in the trench so that 4 to 6 in (100 to 150 mm) of fabric is against the side of the trench with 2 to 4 in (50 to 100 mm) of fabric across the bottom in the upstream direction.

Backfill and compact the trench to ensure that flow cannot pass under the barrier. When the slice method is used, compact the soil disturbed by the slice on the upstream side of the silt fence first, and then compact the downstream side.

When installing a silt fence across a waterway that produces significant runoff, place a settling basin in front of the fence to handle the sediment load, if required. Construct a suitable sump hole or storage area according to [Section 163](#).

B. Install silt fence ditch checks

Temporary Silt Fence Ditch Checks

Temporary silt fence ditch checks shall be constructed of the material type selected and shown on the approved erosion and sediment control plan. Item installation shall be constructed and placed according to approved Plan details. Temporary ditch checks shall remain in place until the permanent ditch protection is in place or being installed and the removal is approved by the Engineer.

C. Remove the Silt Fence

Keep all silt fence in place unless or until the Engineer directs it to be removed. A removed silt fence may be used at other locations if the Engineer approves of its condition.

After removing the silt fence, dress-the area to natural ground, grass-and mulch the area according to [Section 700](#).

The silt fence shall remain until the Project is accepted or until the fence is removed. Also, remove and dispose of the silt accumulations at the silt fence.

Remove and replace any deteriorated filter fabric that reduces the effectiveness of the silt fence.

Repair or replace any undermined silt fence at no additional cost to the Department.

171.3.06 Quality Acceptance

Approved silt fence is listed in [QPL 36](#). Approved fabrics must consistently exceed the minimum requirements of this Specification as verified by the Office of Materials and Research. The Office of Materials and Research will remove fabric that fails to meet the minimum requirements of this specification from the QPL until the products' acceptability has been reestablished to the Department's satisfaction.

At the time of installation, the Engineer will reject the fabric if it has defects, rips, holes, flaws, deterioration, or damage incurred during manufacture, transportation, or storage.

171.3.07 Contractor Warranty

The silt fence shall remain until the Project is accepted or until the fence is removed. Also, remove and dispose of the silt accumulations at the silt fence.

Remove and replace any deteriorated filter fabric that reduces the effectiveness of the silt fence.

Repair or replace any undermined silt fence at no additional cost to the Department.

Delete Subsection 171.4 and 171.5.

Add Subsection 170.4

Measurement and Payment:

No separate measurement or payment will be made for this item. This item will be included in price bid for CONSTRUCTION COMPLETE. Includes furnishing materials, erecting the fence, dressing and grassing, when required, and removing the fence, when required

If the silt fence must be repaired or removed, as the result of neglect or damage, perform the work at no additional cost to the Department.

171.5.01 Adjustments

General Provisions 101 through 150.

Office of Materials and Research

First Use: February 3, 2006
Revised: February 6, 2006
Revised: July 17, 2006
Revised September 27, 2006
Revised: December 7, 2006
(On System) Revised: February 22, 2007
(On System) Revised: December 5, 2007
Revised: February 4, 2008

DEPARTMENT OF TRANSPORTATION

STATE OF GEORGIA

Project Number: CSNHS-0008-00(415)

P.I. Number: 0008415

Fulton County

SPECIAL PROVISION

Section 400—Hot Mix Asphaltic Concrete Construction

Delete Section 400 and substitute the following:

400.1 General Description

This work includes constructing one or more courses of bituminous plant mixture on the prepared foundation or existing roadway surface. The mixture shall conform with lines, grades, thicknesses, and typical cross sections shown on the Plans or established by the Engineer.

This section includes the requirements for all bituminous plant mixtures regardless of the gradation of the aggregates, type and amount of bituminous material, or pavement use.

Acceptance of work is on a lot-to-lot basis according to the requirements of this Section and [Section 106](#).

400.1.01 Definitions

Segregated Mixture: Mixture lacking homogeneity in HMA constituents of such a magnitude that there is a reasonable expectation of accelerated pavement distress or performance problems. May be quantified by measurable changes in temperature, gradation, asphalt content, air voids, or surface texture.

New Construction: A roadway section more than 0.5 mile (800 m) long that is not longitudinally adjacent to the existing roadway. If more than one lane is added, and if any of the lanes are longitudinally adjacent to the existing lane, the lanes shall be tested under the criteria for a resurfacing project.

Trench Widening: Widening no more than 4 ft. (1.2 m) in width.

Comparison sample: Opposite quarter of material sampled by the Contractor.

Quality assurance sample: Independent sample taken by the Department.

Referee sample: A sample of the material remaining after quartering which is used for evaluation if a comparison of Contractor and Departmental test results is outside allowable tolerances.

400.1.02 Related References

A. Standard Specifications

[Section 106—Control of Materials](#)

Section 400—Hot Mix Asphaltic Concrete Construction

[Section 109—Measurement and Payment](#)

[Section 152—Field Laboratory Building](#)

[Section 413—Bituminous Tack Coat](#)

[Section 424—Bituminous Surface Treatment](#)

[Section 802—Coarse Aggregate for Asphaltic Concrete](#)

[Section 828—Hot Mix Asphaltic Concrete Mixtures](#)

B. Referenced Documents

AASHTO T 209

AASHTO T 202

AASHTO T 49

Laboratory Standard Operating Procedure (SOP) 27, “Quality Assurance for Hot Mix Asphaltic Concrete Plants in Georgia”

Department of Transportation Standard Operating Procedure (SOP) 15

[GDT 38](#)

[GDT 73](#)

[GDT 78](#)

[GDT 83](#)

[GDT 93](#)

[GDT 119](#)

[GDT 125](#)

[GDT 134](#)

[GSP 15](#)

[GSP 21](#)

[QPL 1](#)

[QPL 2](#)

[QPL 7](#)

[QPL 26](#)

[QPL 30](#)

[QPL 39](#)

[QPL 41](#)

[QPL 45](#)

[QPL 65](#)

[QPL 67](#)

[QPL 70](#)

[QPL 77](#)

Section 400—Hot Mix Asphaltic Concrete Construction

400.1.03 Submittals

A. Invoices

When the Department requests, furnish formal written invoices from a supplier for all materials used in production of HMA. Show the following on the Bill of Lading:

- Date shipped
- Quantity in tons (megagrams)
- Included with or without additives (for asphalt cement)

Purchase asphaltic cement from a supplier who will provide copies of Bill of Lading upon the Department's request.

B. Paving Plan

Before starting asphaltic concrete construction, submit a written paving plan to the Engineer for approval. Include the following on the paving plan:

- Proposed starting date
- Location of plant(s)
- Rate of production
- Average haul distance(s)
- Number of haul trucks
- Paver speed feet (meter)/minute for each placement operation
- Mat width for each placement operation
- Number and type of rollers for each placement operation
- Sketch of the typical section showing the paving sequence for each placement operation
- Electronic controls used for each placement operation
- Temporary pavement marking plan

If staged construction is designated in the Plans or contract, provide a paving plan for each construction stage.

If segregation is detected, submit a written plan of measures and actions to prevent segregation. Work will not continue until the plan is submitted to and approved by the Department.

C. Job Mix Formula

After the Contract has been awarded, submit to the Engineer a written job mix formula proposed for each mixture type to be used based on an approved mix design. Furnish the following information for each mix:

- Specific project for which the mixture will be used
- Source and description of the materials to be used
- Mixture I.D. Number
- Proportions of the raw materials to be combined in the paving mixture
- Single percentage of the combined mineral aggregates passing each specified sieve
- Single percentage of asphalt by weight of the total mix to be incorporated in the completed mixture
- Single temperature at which to discharge the mixture from the plant
- Theoretical specific gravity of the mixture at the designated asphalt content
- Name of the person or agency responsible for quality control of the mixture during production

Do the following to have the formulas approved and to ensure their quality:

1. Submit proposed job mix formulas for review at least two weeks before beginning the mixing operations.
2. Do not start hot mix asphaltic concrete work until the Engineer has approved a job mix formula for the mixture to be used. No mixture will be accepted until the Engineer has given approval.
3. Provide mix designs for all Superpave and 4.75 mm mixes to be used. The Department will provide mix design results for other mixes to be used.

Section 400—Hot Mix Asphaltic Concrete Construction

4. After a job mix formula has been approved, assume responsibility for the quality control of the mixtures supplied to the Department according to [Subsection 106.01, “Source of Supply and Quantity of Materials.”](#)

D. Quality Control Program

Submit a Quality Control Plan to the Office of Materials and Research for approval. The Quality Control Program will be included as part of the certification in the annual plant inspection report.

400.2 Materials

Ensure that materials comply with the specifications listed in Table 1.

Table 1—Materials Specifications

Material	Subsection
Asphalt Cement, Grade Specified	820.2
Coarse Aggregates for Asphaltic Concrete	802.2.02
Fine Aggregates for Asphaltic Concrete	802.2.01
Mineral Filler	883.1
Heat Stable Anti-Stripping Additive	831.2.04
Hydrated Lime	882.2.03
Silicone Fluid	831.2.05
Bituminous Tack Coat: PG 58-22, PG 64-22, PG 67-22	820.2
Hot Mix Asphaltic Concrete Mixtures	828
Fiber Stabilizing Additives	819

When required, provide Uintaite material, hereafter referred to by the common trade name Gilsonite, as a reinforcing agent for bituminous mixtures. Supply a manufacturer’s certification that the Gilsonite is a granular solid which meets the following requirements:

Softening Point (AASHTO: T-53)	300-350 °F (150-175 °C)
Specific Gravity, 77 °F (25 °C) (AASHTO: T-228)	1.04 ± 0.02
Flash Point, COC (AASHTO: T-48)	550 °F (290 °C) Min.
Ash Content (AASHTO: T-111)	1.0% Max.
Penetration, 77 °F (25 °C), 100 gm., 5 sec. (AASHTO: T-49)	0

400.2.01 Delivery, Storage, and Handling

Storage of material is allowed in a properly sealed and insulated system for up to 24 hours except that Stone Matrix Asphalt (SMA), Open-Graded Friction Course (OGFC), or Porous European Mix (PEM) mixtures shall not be stored more than 12 hours. Mixtures other than SMA, OGFC, or PEM may be stored up to 72 hours in a sealed and insulated system, equipped with an auxiliary inert gas system, with the Engineer’s approval. Segregation, lumpiness, drain-down, or stiffness of stored mixture is cause for rejection of the mixture. The Engineer will not approve using a storage or surge bin if the mixture segregates, loses excessive heat, or oxidizes during storage.

The Engineer may obtain mixture samples or recover asphalt cement according to [GDT 119](#). AASHTO T 202 and T 49 will be used to perform viscosity and penetration tests to determine how much asphalt hardening has occurred.

A. Vehicles for Transporting and Delivering Mixtures

Ensure that trucks used for hauling bituminous mixtures have tight, clean, smooth beds.

Follow these guidelines when preparing vehicles to transport bituminous mixtures:

Section 400—Hot Mix Asphaltic Concrete Construction

1. Use an approved releasing agent from [OPL 39](#) in the transporting vehicle beds, if necessary, to prevent the mixture from sticking to the bed. Ensure that the releasing agent is not detrimental to the mixture. When applying the agent, drain the excess agent from the bed before loading. Remove from the project any transporting vehicles determined to contain unapproved releasing agents.
2. Protect the mixture with a waterproof cover large enough to extend over the sides and ends of the bed. Securely fasten the waterproof cover before the vehicle begins moving.
3. Insulate the front end and sides of each bed with an insulating material with the following specifications:
 - Consists of builders insulating board or equivalent
 - Has a minimum “R” value of 4.0
 - Can withstand approximately 400 °F (200 °C) temperatures

Install the insulating material so it is protected from loss and contamination. A “Heat Dump Body” may be used in lieu of insulation of the bed. “Heat Dump Body” refers to any approved transport vehicle that is capable of diverting engine exhaust and transmitting heat evenly throughout the dump body to keep asphalt at required temperature. Mark the “Heat Dump Body” clearly with “OPEN” and “CLOSE” position at the exhaust diverter. Install a padlock and lock it in the “OPEN” position when the “Heat Dump Body” is used to transport bituminous mixtures.

4. Mark each transporting vehicle with a clearly visible identification number.
5. Create a hole in each side of the bed so that the temperature of the loaded mixture can be checked. The placement of these holes shall be located to assure that the thermometer is being placed in the hot mix asphaltic concrete.

Ensure that the mixture is delivered to the roadway at a temperature within ± 20 °F (± 11 °C) of the temperature on the job mix formula.

If the Engineer determines that a truck may be hazardous to the Project or adversely affect the quality of the work, remove the truck from the project.

B. Containers for Transporting, Conveying, and Storing Bituminous Material

To transport, convey, and store bituminous material, use containers free of foreign material and equipped with sample valves. Bituminous material will not be accepted from conveying vehicles if material has leaked or spilled from the containers.

400.3 Construction Requirements

400.3.01 Personnel

General Provisions 101 through 150.

400.3.02 Equipment

Hot mix asphaltic concrete plants that produce mix for Department use are governed by Quality Assurance for Hot Mix Asphaltic Concrete Plants in Georgia, Laboratory Standard Operating Procedure No. 27.

The Engineer will approve the equipment used to transport and construct hot mix asphaltic concrete. Ensure that the equipment is in satisfactory mechanical condition and can function properly during production and placement operations. Place the following equipment at the plant or project site:

A. Field Laboratory

Provide a field laboratory according to [Section 152](#).

B. Plant Equipment

1. Scales

Provide scales as follows:

- a. Furnish (at the Contractor’s expense) scales to weigh bituminous plant mixtures, regardless of the measurement method for payment.
- b. Ensure that the weight measuring devices that provide documentation comply with [Subsection 109.01, “Measurement and Quantities.”](#)

Section 400—Hot Mix Asphaltic Concrete Construction

- c. When not using platform scales, provide weight devices that record the mixture net weights delivered to the truck. A net weight system will include, but is not limited to:
 - Hopper or batcher-type weight systems that deliver asphaltic mixture directly to the truck
 - Fully automatic batching equipment with a digital recording device
 - d. Use a net weight printing system only with automatic batching and mixing systems approved by the Engineer.
 - e. Ensure that the net weight scale mechanism or device manufacturer, installation, performance, and operation meets the requirements in [Subsection 109.01, “Measurement and Quantities”](#)
 - f. Provide information on the Project tickets according to Department of Transportation SOP-15.
2. Time-Locking Devices
- Furnish batch type asphalt plants with automatic time-locking devices that control the mixing time automatically. Construct these devices so that the operator cannot shorten or eliminate any portion of the mixing cycle.
3. Surge- and Storage-Systems
- Provide surge and storage bins as follows:
- a. Ensure that bins for mixture storage are insulated and have a working seal, top and bottom, to prevent outside air infiltration and to maintain an inert atmosphere during storage. Bins not intended as storage bins may be used as surge bins to hold hot mixtures for part of the working day. However, empty these surge bins completely at the end of the working day.
 - b. Ensure that surge and storage bins can retain a predetermined minimum level of mixture in the bin when the trucks are loaded.
 - c. Ensure that surge and storage systems do not contribute to mix segregation, lumpiness, drain-down, or stiffness.
4. Controls for Dust Collector Fines
- Control dust collection as follows:
- a. When collecting airborne aggregate particles and returning them to the mixture, have the return system meter all or part of the collected dust uniformly into the aggregate mixture and waste the excess. The collected dust percentage returned to the mixture is subject to the Engineer’s approval.
 - b. When the collected dust is returned directly to the hot aggregate flow, interlock the dust feeder with the hot aggregate flow and meter the flow to maintain a flow that is constant, proportioned, and uniform.
5. Mineral Filler Supply System
- When mineral filler is required as a mixture ingredient:
- a. Use a separate bin and feed system to store and proportion the required quantity into the mixture with uniform distribution.
 - b. Control the feeder system with a proportioning device that meets these specifications:
 - Is accurate to within ± 10 percent of the filler required
 - Has a convenient and accurate means of calibration
 - Interlocks with the aggregate feed or weigh system to maintain the correct proportions for all rates of production and batch sizes
 - c. Provide flow indicators or sensing devices for the mineral filler system and interlock them with the plant controls to interrupt the mixture production if mineral filler introduction fails to meet the required target value after no longer than 60 seconds.
 - d. Add mineral filler to the mixture as follows, according to the plant type:
 - Batch Type Asphalt Plant. Add mineral filler to the mixture in the weigh hopper.
 - Continuous Plant Using Pugmill Mixers. Feed the mineral filler into the hot aggregate before it is introduced into the mixer so that dry mixing is accomplished before the bituminous material is added.

Section 400—Hot Mix Asphaltic Concrete Construction

- Continuous Plants Using the Drier-Drum Mixers. Add the mineral filler so that dry mixing is accomplished before the bituminous material is added and ensure that the filler does not become entrained into the air stream of the drier.

6. Hydrated Lime Treatment System

When hydrated lime is required as a mixture ingredient:

- a. Use a separate bin and feed system to store and proportion the required quantity into the mixture.
- b. Ensure that the aggregate is uniformly coated with hydrated lime aggregate before adding the bituminous material to the mixture. Add the hydrated lime so that it will not become entrained in the exhaust system of the drier or plant.
- c. Control the feeder system with a proportioning device that meets these specifications:
 - Is accurate to within ± 10 percent of the amount required
 - Has a convenient and accurate means of calibration
 - Interlocks with the aggregate feed or weigh system to maintain the correct proportions for all rates of production and batch sizes and to ensure that mixture produced is properly treated with lime
- d. Provide flow indicators or sensing devices for the hydrated lime system and interlock them with the plant controls to interrupt mixture production if hydrated lime introduction fails to meet the required target value after no longer than 60 seconds.

7. Net Weight Weighing Mechanisms

Certify the accuracy of the net weight weighing mechanisms by an approved registered scale serviceperson at least once every 6 months. Check the accuracy of net weight weighing mechanisms at the beginning of Project production and thereafter as directed by the Engineer. Check mechanism accuracy as follows:

- a. Weigh a load on a set of certified commercial truck scales. Ensure that the difference between the printed total net weight and that obtained from the commercial scales is no greater than 4 lbs/1,000 lbs (4 kg/Mg) of load.

Check the accuracy of the bitumen scales as follows:

- Use standard test weights.
 - If the checks indicate that printed weights are out of tolerance, have a registered scale serviceperson check the batch scales and certify the accuracy of the printer.
 - While the printer system is out of tolerance and before its adjustment, continue production only if using a set of certified truck scales to determine the truck weights.
- b. Have plants that use batch scales maintain ten 50 lb (25 kg) standard test weights at the plant site to check batching scale accuracy.

Ensure that plant scales that are used only to proportion mixture ingredients, not to determine pay quantities, are within two percent throughout the range.

8. Fiber Supply System

When stabilizing fiber is required as a mixture ingredient:

- a. Use a separate feed system to store and proportion by weight the required quantity into the mixture with uniform distribution.
- b. Control the feeder system with a proportioning device that meets these Specifications:
 - Is accurate to within ± 10 percent of the amount required. Automatically adjusts the feed rate to maintain the material within this tolerance at all times
 - Has a convenient and accurate means of calibration
 - Provide in-process monitoring, consisting of either a digital display of output or a printout of feed rate, in pounds (kg) per minute, to verify feed rate
 - Interlocks with the aggregate feed or weigh system to maintain the correct proportions for all rates of production and batch sizes
- c. Provide flow indicators or sensing devices for the fiber system and interlock them with the plant controls to interrupt the mixture production if fiber introduction fails or if the output rate is not within the tolerances given above.
- d. Introduce the fiber as follows:

Section 400—Hot Mix Asphaltic Concrete Construction

- When a batch type plant is used, add the fiber to the aggregate in the weigh hopper. Increase the batch dry mixing time by 8 to 12 seconds from the time the aggregate is completely emptied into the mixer to ensure the fibers are uniformly distributed prior to the injection of asphalt cement into the mixer.
- When a continuous or drier-drum type plant is used, add the fiber to the aggregate and uniformly disperse prior to the injection of asphalt cement. Ensure the fibers will not become entrained in the exhaust system of the drier or plant.

C. Equipment at Project Site

1. Cleaning Equipment

Provide sufficient hand tools and power equipment to clean the roadway surface before placing the bituminous tack coat. Use power equipment that complies with [Subsection 424.3.02.F, “Power Broom and Power Blower.”](#)

2. Pressure Distributor

To apply the bituminous tack coat, use a pressure distributor that complies with [Subsection 424.3.02.B, “Pressure Distributor.”](#)

3. Bituminous Pavers

To place hot mix asphaltic concrete, use bituminous pavers that can spread and finish courses that are:

- As wide and deep as indicated on the Plans
 - True to line, grade, and cross section
 - Smooth
 - Uniform in density and texture
- a. Continuous Line and Grade Reference Control. Furnish, place, and maintain the supports, wires, devices, and materials required to provide continuous line and grade reference control to the automatic paver control system.
 - b. Automatic Screed Control System. Equip the bituminous pavers with an automatic screed control system actuated from sensor-directed mechanisms or devices that will maintain the paver screed at a pre-determined transverse slope and elevation to obtain the required surface.
 - c. Transverse Slope Controller. Use a transverse slope controller capable of maintaining the screed at the desired slope within ± 0.1 percent. Do not use continuous paving set-ups that result in unbalanced screed widths or off-center breaks in the main screed cross section unless approved by the Engineer.
 - d. Screed Control. Equip the paver to permit the following four modes of screed control. The method used shall be approved by the Engineer.
 - Automatic grade sensing and slope control
 - Automatic dual grade sensing
 - Combination automatic and manual control
 - Total manual control

Ensure that the controls are referenced with a taut string or wire set to grade, or with a ski-type device or mobile reference at least 30 ft (9 m) long when using a conventional ski. A non-contacting laser or sonar-type ski with at least four referencing mobile stations may be used with a reference at least 24 ft. (7.3 m) long. Under limited conditions, a short ski or shoe may be substituted for a long ski on the second paver operating in tandem, or when the reference plane is a newly placed adjacent lane.

Automatic screed control is required on all Projects; however, when the Engineer determines that Project conditions prohibit the use of such controls, the Engineer may waive the grade control, or slope control requirements, or both.

- e. Paver Screed Extension. When the laydown width requires a paver screed extension, use bolt-on screed extensions to extend the screeds, or use an approved mechanical screed extension device. When the screed is extended, add auger extensions to assure a length of no more than 18 inches from the auger to the end gate of the paver. Auger extensions may be omitted when paving variable widths. Ensure the paver is equipped with tunnel extensions when the screed and augers are extended.

Section 400—Hot Mix Asphaltic Concrete Construction

- f. 30 - 45 Degree Wedge. When shown on/required by the plans, equip the paver to ensure a 30 degree minimum up to a 45 degree maximum wedge along the outside edge of the roadway (measured from the horizontal plane) is in place after final compaction on the final surface course. Use an approved mechanical device that will:
- Apply compactive effort to the asphalt mixture to eliminate objectionable voids as the mixture passes through the wedge device
 - Produce a wedge with a uniform texture, shape, and density while automatically adjusting to varying heights encountered along the roadway shoulder.

NOTE: Do not use extendible strike-off devices instead of approved screed extensions. Only use a strike-off device in areas that would normally be luted in by hand labor.

4. Compaction Equipment

Ensure that the compaction equipment is in good mechanical condition and can compact the mixture to the required density. The compaction equipment number, type, size, operation, and condition is subject to the Engineer's approval

5. Materials Transfer Vehicle (MTV)

- a. Use a Materials Transfer Vehicle (MTV) when placing asphaltic concrete mixtures on Projects on the state route system with the following conditions. If a project fails to meet any one of the following conditions, the MTV's use is not required.

1) When to use:

- The ADT is equal to or greater than 6000,
- The project length is equal to or greater than 3000 linear feet (915 linear meters),
- The total tonnage (megagrams) of all asphaltic concrete mixtures is greater than 2000 tons (1815 Mg).

2) Where to use:

- Mainline of the traveled way
- Collector/distributor (C/D) lanes on Interstates and limited access roadways
- Leveling courses at the Engineer's discretion

3) Do not use the MTV for the following conditions:

- A resurfacing project that only 9.5 mm mix is required.
- A project with lane width that is equal or less than 11 feet.
- A passing lane only project.
- When noted on the plans.

- b. Ensure the MTV and conventional paving equipment meet the following requirements:

1) MTV

- Has a truck unloading system which receives mixture from the hauling equipment and independently deliver mixtures from the hauling equipment to the paving equipment.
- Has mixture remixing capability by either a storage bin in the MTV with a minimum capacity of 14 tons (13 megagrams) of mixture and a remixing system in the bottom of MTV storage bin, or a dual pugmill system located in the paver hopper insert with two full length transversely mounted paddle mixers to continuously blend the mixture as it discharges to a conveyor system.

Section 400—Hot Mix Asphaltic Concrete Construction

- Provides to the paver a homogeneous, non-segregated mixture of uniform temperature with no more than 20 °F(18 °C) difference between the highest and lowest temperatures when measured transversely across the width of the mat in a straight line at a distance of one foot to three feet from the screed while the paver is operating. Ensure that the MTV is capable of providing the paver a consistent material flow that is sufficient to prevent the paver from stopping between truck exchanges.
- 2) Conventional Paving Equipment
- Has a paver hopper insert with a minimum capacity of 14 tons (13 Mg) installed in the hopper of conventional paving equipment when an MTV is used.
- c. If the MTV malfunctions during spreading operations, discontinue placement of hot mix asphaltic concrete after there is sufficient hot mix placed to maintain traffic in a safe manner. However, placement of hot mix asphaltic concrete in a lift not exceeding 2 in. (50 mm) may continue until any additional hot mix in transit at the time of the malfunction has been placed. Cease spreading operations thereafter until the MTV is operational.
- d. Ensure the MTV is empty when crossing a bridge and is moved across without any other Contractor vehicles or equipment on the bridge. Move the MTV across a bridge in a travel lane and not on the shoulder. Ensure the speed of the MTV is no greater than 5 mph (8 kph) without any acceleration or deceleration while crossing a bridge.

400.3.03 Preparation

A. Prepare Existing Surface

Prepare the existing surface as follows:

1. Clean the Existing Surface. Before applying hot mix asphaltic concrete pavement, clean the existing surface to the Engineer's satisfaction.
2. Patch and Repair Minor Defects
Before placing leveling course:
 - a. Correct potholes and broken areas that require patching in the existing surface and base as directed by the Engineer.
 - b. Cut out, trim to vertical sides, and remove loose material from the areas to be patched.
 - c. Prime or tack coat the area after it has been cleaned. Compact patches to the Engineer's satisfaction. Material for patches does not require a job mix formula, but shall meet the gradation range shown in [Section 828](#). The Engineer must approve the asphalt content to be used.
3. Apply Bituminous Tack Coat
Apply the tack coat according to [Section 413](#). The Engineer will determine the application rate, which must be within the limitations Table 2.

Table 2—Application Rates for Bituminous Tack, gal/yd² (L/m²)

	Minimum	Maximum
Under OGFC and PEM Mixes	0.06 (0.270)	0.08 (0.360)
All Other Mixes	0.04 (0.180)	0.06(0.270)
*On thin leveling courses and freshly placed asphaltic concrete mixes, reduce the application rate to 0.02 to 0.04 gal/yd ² (0.09 to 0.18 L/m ²).		

B. Place Patching and Leveling Course

1. When the existing surface is irregular, bring it to the proper cross section and grade with a leveling course of hot mix asphaltic concrete materials.
2. Place leveling at the locations and in the amounts directed by the Engineer.

Section 400—Hot Mix Asphaltic Concrete Construction

3. Use leveling course mixtures that meet the requirements of the job mix formulas defined in:
 - [Subsection 400.3.05.A, “Observe Composition of Mixtures”](#)
 - [Section 828](#)
 - Leveling acceptance schedules in [Subsection 400.3.06.A, “Acceptance Plans for Gradation and Asphalt Cement Content”](#)
4. If the leveling and patching mix type is undesignated, determine the mix type by the thickness or spread rate according to Table 3, but do not use 4.75 mm mix on interstate projects.

Table 3—Leveling and Patching Mix Types

Thickness	Rate of Spread	Type of Mix
Up to 0.75 in (19 mm)	Up to 85 lbs/yd ² (45 kg/m ²)	4.75 mm Mix or 9.5 mm Superpave Type 1
0.75 to 1.5 in (19 to 38 mm)	85 to 165 lbs/yd ² (45 to 90 kg/m ²)	9.5 mm Superpave Type 2
1.5 to 2 in (38 to 50 mm)	165 to 220 lbs/yd ² (90 to 120 kg/m ²)	12.5 mm Superpave *
2 to 2.5 in (50 to 64 mm)	220 to 275 lbs/yd ² (120 to 150 kg/m ²)	19 mm Superpave *
Over 2.5 in (64 mm)	Over 275 lbs/yd ² (150 kg/m ²)	25 mm Superpave

* These mixtures may be used for isolated patches no more than 6 in. (150 mm) deep and no more than 4 ft. (1.2 m) in diameter or length.

400.3.04 Fabrication

General Provisions 101 through 150.

400.3.05 Construction

Provide the Engineer at least one day’s notice prior to beginning construction, or prior to resuming production if operations have been temporarily suspended.

A. Observe Composition of Mixtures

1. Calibration of plant equipment

If the material changes, or if a component affecting the ingredient proportions has been repaired, replaced, or adjusted, check and recalibrate the proportions.

Calibrate as follows:

- a. Before producing mixture for the Project, calibrate by scale weight the electronic sensors or settings for proportioning mixture ingredients.
- b. Calibrate ingredient proportioning for all rates of production.

2. Mixture control

Compose hot mix asphaltic concrete from a uniform mixture of aggregates, bituminous material, and if required, hydrated lime, mineral filler, or other approved additive.

Make the constituents proportional to produce mixtures that meet the requirements in [Section 828](#). The general composition limits prescribed are extreme ranges within which the job mix formula must be established. Base mixtures on a design analysis that meets the requirements of [Section 828](#). Ensure that the field performance of the in-place mixtures meet the requirements of [Subsection 828.2B](#).

Section 400—Hot Mix Asphaltic Concrete Construction

If control test results show that the characteristic tested does not conform to the job mix formula control tolerances given in [Section 828](#), take immediate action to ensure that the quality control methods are effective.

Control the materials to ensure that extreme variations do not occur. Maintain the gradation within the composition limits in [Section 828](#).

B. Prepare Bituminous Material

Uniformly heat the bituminous material to the temperature specified in the job mix formula with a tolerance of ± 20 °F (± 10 °C).

C. Prepare the Aggregate

Prepare the aggregate as follows:

1. Heat the aggregate for the mixture, and ensure a mix temperature within the limits of the job mix formula.
2. Do not contaminate the aggregate with fuel during heating.
3. Reduce the absorbed moisture in the aggregate until the asphalt does not separate from the aggregate in the prepared mixture. If this problem occurs, the Engineer will establish a maximum limit for moisture content in the aggregates. When this limit is established, maintain the moisture content below this limit.

D. Prepare the Mixture

Proportion the mixture ingredients as necessary to meet the required job mix formula. Mix until a homogenous mixture is produced.

1. Add Mineral Filler

When mineral filler is used, introduce it in the proper proportions and as specified in [Subsection 400.3.02.B.5, “Mineral Filler Supply System.”](#)

2. Add Hydrated Lime

When hydrated lime is included in the mixture, add it at a rate specified in [Section 828](#) and the job mix formula. Use methods and equipment for adding hydrated lime according to [Subsection 400.3.02.B.6, “Hydrated Lime Treatment System.”](#)

Add hydrated lime to the aggregate by using Method A or B as follows:

Method A—Dry Form—Add hydrated lime in its dry form to the mixture as follows, according to the type of plant:

- a. Batch Type Asphalt Plant: Add hydrated lime to the mixture in the weigh hopper or as approved and directed by the Engineer.
- b. Continuous Plant Using Pugmill Mixer: Feed hydrated lime into the hot aggregate before it is introduced into the mixer so that dry mixing is complete before the bituminous material is added.
- c. Continuous Plant Using Drier-Drum Mixer: Add hydrated lime so that the lime will not become entrained into the air stream of the drier and so that thorough dry mixing will be complete before the bituminous material is added.

Method B—Lime/Water Slurry—Add the required quantity of hydrated lime (based on dry weight) in lime/water slurry form to the aggregate. This solution consists of lime and water in concentrations as directed by the Engineer. Equip the plant to blend and maintain the hydrated lime in suspension and to mix it with the aggregates uniformly in the proportions specified.

3. Add Stabilizing Fiber

When stabilizing fiber is included in the mixture, add it at a rate specified in [Section 819](#) and the Job Mix Formula. Introduce it as specified in [Subsection 400.3.02.B.8, “Fiber Supply System.”](#)

4. Add Gilsonite Modifier

When required, add the Gilsonite modifier to the mixture at a rate such that eight percent by weight of the asphalt cement is replaced by Gilsonite. Use either PG 64-22 or PG 67-22 asphalt cement as specified in [Subsection 820.2.01](#). Provide suitable means to calibrate and check the rate of Gilsonite being added. Introduce Gilsonite modifier by either of the following methods.

- a. For batch type plants, incorporate Gilsonite into the pugmill at the beginning of the dry mixing cycle. Increase the dry mix cycle by a minimum of 10 seconds after the Gilsonite is added and prior to introduction of the asphalt cement. For this method, supply Gilsonite in plastic bags to protect the material during shipment and

Section 400—Hot Mix Asphaltic Concrete Construction

handling and store the modifier in a waterproof environment. The bags shall be capable of being completely melted and uniformly blended into the combined mixture.

Gilsonite may also be added through a mineral filler supply system as described in [Subsection 400.3.02.B.5, “Mineral Filler Supply System.”](#) The system shall be capable of injecting the modifier into the weigh hopper near the center of the aggregate batching cycle so the material can be accurately weighed.

- b. For drum drier plants, add Gilsonite through the recycle ring or through an acceptable means which will introduce the Gilsonite prior to the asphalt cement injection point. The modifier shall be proportionately fed into the drum mixer at the required rate by a proportioning device which shall be accurate within ± 10 percent of the amount required. The entry point shall be away from flames and ensure the Gilsonite will not be caught up in the air stream and exhaust system.

5. Materials from Different Sources

Do not use mixtures prepared from aggregates from different sources intermittently. This will cause the color of the finished pavement to vary.

E. Observe Weather Limitations

Do not mix and place asphaltic concrete if the existing surface is wet or frozen. Do not lay asphaltic concrete OGFC mix or PEM at air temperatures below 60 °F (16 °C). When using a MTV, OGFC mix or PEM may be placed at 55 °F (13 °C) when approved by the Engineer. For other courses, follow the temperature guidelines in the following table:

Table 4—Lift Thickness Table

Lift Thickness	Minimum Temperature
1 in (25 mm) or less	55 °F (13 °C)
1.1 to 2 in (26 mm to 50 mm)	45 °F (8 °C)
2.1 to 3 in (51 mm to 75 mm)	40 °F (4 °C)
3.1 to 4 in (76 mm to 100 mm)	35 °F (2 °C)
4.1 to 8 in (101 mm to 200 mm)	32 °F (0 °C) and rising. Base Material must not be frozen.

F. Perform Spreading and Finishing

Spread and finish the course as follows:

1. Determine the course’s maximum compacted layer thickness by the type mix being used according to Table 5.

Table 5—Maximum Layer Thickness

Mix Type	Minimum Layer Thickness	Maximum Layer Thickness	Maximum Total Thickness
25 mm Superpave	2 1/2 in (64 mm)	4 in (100 mm) *	—
19 mm Superpave	1 3/4 in (44 mm)	3 in (75 mm) *	—
12.5 mm Superpave	1 3/8 in (35 mm)	2 1/2 in (64 mm)*	8 in (200 mm)
9.5 mm Superpave Type 2	1 1/8 in.(28 mm)	1 1/2 in (38 mm)	4 in (100 mm)
9.5 mm Superpave Type 1	7/8 in (22 mm)	1 1/4 in (32 mm)	4 in (100 mm)
4.75 mm Mix	3/4 in (19 mm)	1 1/8 in (28 mm)	2 in (50 mm)
9.5 mm OGFC	55 lbs/yd ² (30 kg/m ²)	65 lbs/yd ² (36 kg/m ²)	—
12.5 mm OGFC	85 lbs/yd ² (47 kg/m ²)	95 lbs/yd ² (53 kg/m ²)	—
12.5 mm PEM	110 lbs/yd ² (80 kg/m ²)	165 lbs/yd ² (90 kg/m ²)	—
9.5 mm SMA	1 1/8 in (28 mm)	1 1/2 in (38 mm)	4 in (100 mm)
12.5 mm SMA	1 1/4 in (32 mm)	3 in (75 mm)	6 in (150 mm)

Section 400—Hot Mix Asphaltic Concrete Construction

Mix Type	Minimum Layer Thickness	Maximum Layer Thickness	Maximum Total Thickness
19 mm SMA	1 3/4 in (44 mm)	3 in (75 mm)	—
* Allow up to 6 in (150 mm) per lift on trench widening. Place 9.5 mm Superpave and 12.5 mm Superpave up to 4 in (100 mm) thick for driveway and side road transition.			

2. Unload the mixture into the paver hopper or into a device designed to receive the mixture from delivery vehicles.
3. Except for leveling courses, spread the mixture to the loose depth for the compacted thickness or the spread rate. Use a mechanical spreader true to the line, grade, and cross section specified.
4. For leveling courses, use a motor grader equipped with a spreader box and smooth tires to spread the material or use a mechanical spreader meeting the requirements in [Subsection 400.3.02.C, “Equipment at Project Site.”](#)
5. Obtain the Engineer’s approval for the sequence of paving operations, including paving the adjoining lanes. Minimize tracking tack onto surrounding surfaces.
6. Ensure that the outside edges of the pavement being laid are aligned and parallel to the roadway center line.
7. For New Construction or Resurfacing Contracts that contain multiple lifts or courses, arrange the width of the individual lifts so that the longitudinal joints of each successive lift are offset from the previous lift at least 1 ft (300 mm). This requirement does not apply to the lift immediately over thin lift leveling courses.
Ensure that the longitudinal joint(s) in the surface course and the mix immediately underneath asphaltic concrete OGFC or PEM are at the lane line(s).

NOTE: Perform night work with artificial light provided by the Contractor and approved by the Engineer.

8. Where mechanical equipment cannot be used, spread and rake the mixture by hand. Obtain the Engineer’s approval of the operation sequence, including compactive methods, in these areas.
9. Keep small hand raking tools clean and free from asphalt build up. Do not use fuel oil or other harmful solvents to clean tools during the work.
10. Do not use mixture with any of these characteristics:
 - Segregated
 - Nonconforming temperature
 - Deficient or excessive asphalt cement content
 - Otherwise unsuitable to place on the roadway in the work
11. Remove and replace mixture placed on the roadway that the Engineer determines has unacceptable blemish levels from segregation, streaking, pulling and tearing, or other characteristics. Replace with acceptable mixture at the Contractor’s expense. Do not continually place mixtures with deficiencies.
Do not place subsequent course lifts over another lift or courses placed on the same day while the temperature of the previously placed mix is 140 °F (60 °C) or greater.
12. Obtain the Engineer’s approval of the material compaction equipment. Perform the rolling as follows:
 - a. Begin the rolling as close behind the spreader as possible without causing excessive distortion of the asphaltic concrete surface.
 - b. Continue rolling until roller marks are no longer visible.
 - c. Use pneumatic-tired rollers with breakdown rollers on all courses except asphaltic concrete OGFC, PEM and SMA or other mixes designated by the Engineer.
13. If applicable, taper or “feather” asphaltic concrete from full depth to a depth no greater than 0.5 in (13 mm) along curbs, gutters, raised pavement edges, and areas where drainage characteristics of the road must be retained. The Engineer will determine the location and extent of tapering.

Section 400—Hot Mix Asphaltic Concrete Construction

G. Maintain Continuity of Operations

Coordinate plant production, transportation, and paving operations to maintain a continuous operation. If the spreading operations are interrupted, construct a transverse joint if the mixture immediately behind the paver screed cools to less than 250 °F (120 °C).

H. Construct the Joints

1. Construct Transverse Joints

- a. Construct transverse joints to facilitate full depth exposure of the course before resuming placement of the affected course.
- b. Properly clean and tack the vertical face of the transverse joint before placing additional material.

NOTE: Never burn or heat the joint by applying fuel oil or other volatile materials.

- c. Straightedge transverse joints immediately after forming the joint.
- d. Immediately correct any irregularity that exceeds 3/16 in. in 10 ft (5 mm in 3 m).

2. Construct Longitudinal Joints

Clean and tack the vertical face of the longitudinal joint before placing adjoining material. Construct longitudinal joints so that the joint is smooth, well sealed, and bonded.

3. Construction Joint Detail for OGFC and PEM Mixtures

In addition to meeting joint requirements described above, construct joints and transition areas for 12.5 mm OGFC and 12.5 mm PEM mixtures as follows:

- a. For projects which do not have milling included as a pay item:
 - 1) Place OGFC mixture meeting gradation requirements of 9.5 mm OGFC as specified in [Section 828](#) on entrance and exit ramp gore areas and end of project construction joints.
 - Taper mixture from 3/8 in (10 mm) at end of project to full plan depth within maximum distance of spread for one load of mixture
 - Taper mixture placed on gore areas from thickness of the edge of the mainline to 3/8 in (10 mm) at the point of the ramp transverse joint.
 - 2) Construct the ramp transverse joint at the point specified in the plans or as directed by the Engineer.
 - 3) Mixture placed in the transition and gore areas will be paid for at the contract unit price for 12.5 mm OGFC or 12.5 mm PEM as applicable.
- b. For projects which have milling included as a pay item:
 - 1) Taper milling for a distance of no less than 50 ft (15 m) to a depth of 2 1/4 in (59 mm) at the point of the transverse joint
 - 2) Taper thickness, if needed, of the dense-graded surface mix within the 50 ft (15 m) distance to 1 1/2 in (40 mm) at the point of the transverse joint
 - 3) Taper thickness of the 12.5 mm OGFC or 12.5 mm PEM to 3/4 in (19 mm) so that it ties in at grade level with the existing surface at the point of the transverse joint

I. Protect the Pavement

Protect sections of the newly finished pavement from traffic until the traffic will not mar the surface or alter the surface texture. If directed by the Engineer, use artificial methods to cool the newly finished pavement to open the pavement to traffic more quickly.

J. Modify the Job Mix Formula

If the Engineer determines that undesirable mixture or mat characteristics are being obtained, the job mix formula may require immediate adjustment.

Section 400—Hot Mix Asphaltic Concrete Construction

400.3.06 Quality Acceptance

A. Acceptance Plans for Gradation and Asphalt Cement Content

The Contractor will randomly sample and test mixtures for acceptance on a lot basis. The Department will monitor the Contractor testing program and perform comparison and quality assurance testing.

1. Determine Lot Amount

A lot consists of the tons (megagrams) of asphaltic concrete produced and placed each production day. If this production is less than 500 tons (500 Mg), or its square yard (meter) equivalent, production may be incorporated into the next working day. The Engineer may terminate a lot when a pay adjustment is imminent if a plant or materials adjustment resulting in a probable correction has been made. Terminate all open lots at the end of the month, except for materials produced and placed during the adjustment period. The lot will be terminated as described in [Subsection 400.5.01, "Adjustments"](#).

If the final day's production does not constitute a lot, the production may be included in the lot for the previous day's run; or, the Engineer may treat the production as a separate lot with a corresponding lower number of tests.

2. Determine Lot Acceptance

Determine lot acceptance as found in [Subsection 400.5.01, "Adjustments."](#)

The Department will perform the following task:

Determine the pay factor by using the mean of the deviations from the job mix formula of the tests in each lot and apply it to Table 9—Mixture Acceptance Schedule for Surface Mixes or Table 10—Mixture Acceptance Schedule for Subsurface Mixes, whichever is appropriate. This mean will be determined by averaging the actual numeric value of the individual deviations from the job mix formula, disregarding whether the deviations are positive or negative amounts. Do not calculate lot acceptance using test results for materials not used in the Work. Determine the pay factor for each lot by multiplying the contract unit price by the appropriate pay factor from the Mixture Acceptance Schedule - Table 9 or Table 10. When two or more pay factors for a specific lot are less than 1.0, determine the adjusted payment by multiplying the contract unit price by the lowest pay factor.

If the mean of the deviations from the job mix formula of the lot acceptance tests for a control sieve or for asphalt cement content exceeds the tolerances established in the appropriate Mixture Acceptance Schedule, and if the Engineer determines that the material need not be removed and replaced, the lot may be accepted at an adjusted unit price as determined by the Engineer. If the Engineer determines that the material is not acceptable to leave in place, the materials shall be removed and replaced at the Contractor's expense.

3. Provide Quality Control Program

Provide a Quality Control Program as established in SOP 27 which includes:

- Assignment of quality control responsibilities to specifically named individuals who have been certified by the Office of Materials and Research
- Provisions for prompt implementation of control and corrective measures
- Provisions for communication with Project Manager, Bituminous Technical Services Engineer, and Testing Management Operations Supervisor at all times
- Provisions for reporting all test results daily through the Office of Materials and Research computerized Field Data Collection System; other checks, calibrations and records will be reported on a form developed by the Contractor and will be included as part of the project records
- Notification in writing of any change in quality control personnel

a. Certification Requirements:

- Use laboratory and testing equipment certified by the Department. (Laboratories which participate in and maintain AASHTO accreditation for testing asphaltic concrete mixtures will be acceptable in lieu of Departmental certification.)
- Provide certified quality control personnel to perform the sampling and testing. A Quality Control Technician (QCT) may be certified at three levels:
 - 1) Temporary Certification – must be a technician trainee who shall be given direct oversight by a certified Level 1 or Level 2 QCT while performing acceptance testing duties during the first 5 days of training. The trainee must complete qualification requirements within 30 production days

Section 400—Hot Mix Asphaltic Concrete Construction

after being granted temporary certification. A trainee who does not become qualified within 30 production days will not be re-eligible for temporary certification. A certified Level 1 or Level 2 QCT shall be at the plant at all times during production and shipment of mixture to monitor work of the temporarily certified technician.

- 2) Level 1 – must demonstrate they are competent in performing the process control and acceptance tests and procedures related to hot mix asphalt production and successfully pass a written exam.
- 3) Level 2 – must meet Level 1 requirements and must be capable of and responsible for making process control adjustments, and successfully pass a written exam.
 - Technician certification is valid for 3 years from the date on the technician’s certificate unless revoked or suspended. Eligible technicians may become certified through special training and testing approved by the Office of Materials and Research. Technicians who lose their certification due to falsification of test data will not be eligible for recertification in the future unless approved by the State Materials and Research Engineer.

b. Quality Control Management

- 1) Designate at least one Level 2 QCT as manager of the quality control operation. The Quality Control Manager shall meet the following requirements:

- Be accountable for actions of other QCT personnel
- Ensure that all applicable sampling requirements and frequencies, test procedures, and Standard Operating Procedures are adhered to
- Ensure that all reports, charts, and other documentation is completed as required

- 2) Provide QCT personnel at the plant as follows:

- If daily production for all mix types is to be greater than 250 tons (megagrams), have a QCT person at the plant at all times during production and shipment of mixture until all required acceptance tests have been completed
- If daily production for all mix types will not be greater than 250 tons (megagrams) a QCT may be responsible for conducting tests at up to two plants, subject to random number sample selection
- Have available at the plant or within immediate contact by phone or radio a Level 2 QCT responsible for making prompt process control adjustments as necessary to correct the mix

- 3) Sampling, Testing, and Inspection Requirements.

Provide all sample containers, extractants, forms, diaries, and other supplies subject to approval of the Engineer.

Perform daily sampling, testing, and inspection of mixture production that meets the following requirements:

- (a) Randomly sample mixtures according to [GSP 15](#), and [GDT 73 \(Method C\)](#) and test on a lot basis. In the event less than the specified number of samples are taken, obtain representative 6 in (150 mm) cores from the roadway at a location where the load not sampled was placed. Take enough cores to ensure minimum sample size requirements are met for each sample needed.
- (b) Maintain a printed copy of the computer generated random sampling data as a part of the project records.
- (c) Perform sampling, testing, and inspection duties of [GSP 21](#).
- (d) Perform extraction or ignition test ([GDT 83](#) or [GDT 125](#)) and extraction analysis ([GDT 38](#)). If the ignition oven is used, a printout of sample data including weights shall become a part of the project records. For asphalt cement content only, digital printouts of liquid asphalt cement weights may be substituted in lieu of an extraction test for plants with digital recorders. Calculate the asphalt content from the ticket representing the mixture tested for gradation.
- (e) Save extracted aggregate, opposite quarters, and remaining material (for possible referee testing) of each sample as follows:
 - Store in properly labeled, suitable containers
 - Secure in a protected environment

Section 400—Hot Mix Asphaltic Concrete Construction

- Store for three working days. If not obtained by the Department, within three days they may be discarded.
- (f) Add the following information on load tickets from which a sample or temperature check is taken:
- Mixture temperature
 - Signature of the QCT person performing the testing
- (g) Calibrate the lime system when hydrated lime is included in the mixture:
- Perform a minimum of twice weekly during production
 - Post results at the plant for review
 - Provide records of materials invoices upon request (including asphalt cement, aggregate, hydrated lime, etc.)
- (h) Take action if acceptance test results are outside Mixture Control Tolerances of [Section 828](#).
- One sample out of tolerance
 - (1) Contact Level 2 - QCT to determine if a plant adjustment is needed
 - (2) Immediately run a process control sample. Make immediate plant adjustments if this sample is also out of tolerance

NOTE: Determine mixture temperature at least once per hour of production for OGFC and PEM mixes.

- (3) Test additional process control samples as needed to ensure corrective action taken appropriately controls the mixture
- Two consecutive acceptance samples of the same mix type out of tolerance regardless of Lot or mix design level, or three consecutive acceptance samples out of tolerance regardless of mix type
 - (1) Stop plant production immediately
 - (2) Reject any mixture already in storage that:
 - Deviates more than 10 percent in gradation from the job mix formula based on the acceptance sample
 - Deviates more than 0.7 percent in asphalt content from the job mix formula based on the acceptance sample
 - (3) Make a plant correction to any mix type out of tolerance prior to resuming production
 - Do not send any mixture to the project before test results of a process control sample meets Mixture Control Tolerances
 - Reject any mixture produced at initial restarting that does not meet Mixture Control Tolerances

4) Comparison Testing and Quality Assurance Program

Periodic comparison testing by the Department will be required of each QCT to monitor consistency of equipment and test procedures. The Department will take independent samples to monitor the Contractor's quality control program.

a) Comparison Sampling and Testing

Retain samples for comparison testing and referee testing if needed as described in [Subsection 400.3.06.A.3.b.3](#). Discard these samples only if the Contractor's acceptance test results meet a 1.00 pay factor and the Department does not procure the samples within three working days.

The Department will test comparison samples on a random basis. Results will be compared to the respective contractor acceptance tests and the maximum difference shall be as follows:

Table 6—Allowable Percent Difference Between Department and Contractor Acceptance Tests

Section 400—Hot Mix Asphaltic Concrete Construction

<u>SIEVE SIZE</u>	<u>SURFACE</u>	<u>SUB-SURFACE</u>
1/2 in. (12.5 mm)		4.0%
3/8 in. (9.5 mm)	3.5%	4.0%
No. 4 (4.75 mm)	3.5%	3.5%
No. 8 (2.36 mm)	2.5%	3.0%
No. 200 (75 μm)	2.0%	2.0%
A.C.	0.4%	0.5%

NOTE: Pavement courses to be overlaid with OGFC or PEM mixes are considered surface mixes.

- (1) If test comparisons are within these tolerances:
 - Continue production
 - Use the Contractor's tests for acceptance of the lot
 - (2) If test comparisons are not within these tolerances:
 - Another Departmental technician will test the corresponding referee sample
 - Results of the referee sample will be compared to the respective contractor and Departmental tests using the tolerance for comparison samples given above.
 - (a) If referee test results are within the above tolerances when compared to the Contractor acceptance test, use the Contractor's test for acceptance of the effected lot.
 - (b) If referee test results are not within the above tolerances when compared to the Contractor acceptance test, the Department will review the Contractor's quality control methods and determine if a thorough investigation is needed.
- b) Quality Assurance Sampling and Testing
- (1) Randomly take a minimum of two quality assurance samples from the lesser of five days or five lots of production regardless of mix type or number of projects.
 - (2) Compare test deviation from job mix formula to Mixture Control Tolerances in [Section 828](#). If results are outside these tolerances, another sample from the respective mix may be taken.

NOTE: For leveling courses less than 110 lb/yd² (60 kg/m²) that have quality assurance test results outside the Mixture Control Tolerances of [Section 828](#), use the Department's test results only and applicable pay factors will apply.

If test results of the additional sample are not within Mixture Control Tolerances, the Department will take the following action:

- Take random samples from throughout the lot as in [Subsection 400.3.06.A.3.b.3](#) and use these test results for acceptance and in calculations for the monthly plant rating. Applicable pay factors will apply and the contractor QCT test results will not be included in pay factor calculations nor in the monthly plant rating.
- Determine if the Contractor's quality control program is satisfactory and require prompt corrective action by the Contractor if specification requirements are not being met.

Section 400—Hot Mix Asphaltic Concrete Construction

- Determine if the QCT has not followed Departmental procedures or has provided erroneous information.
- Take samples of any in-place mixture represented by unacceptable QCT tests and use the additional sample results for acceptance and in calculations for the monthly plant rating and apply applicable pay factors. The Contractor QCT tests will not be included in the pay factor calculations nor in the monthly plant rating.

B. Compaction

Determine the mixture compaction using either [GDT 39](#) or [GDT 59](#). The compaction is accepted in lots defined in [Subsection 400.3.06. A “Acceptance Plans for Gradation and Asphalt Cement Content”](#) and is within the same lot boundaries as the mixture acceptance.

1. Calculate Pavement Mean Air Voids

The Department will calculate the pavement air voids placed within each lot as follows:

- a. One test per sub-lot.
- b. Average the results of all tests run on randomly selected sites in that lot.
- c. Select the random sites using [GDT 73](#).

Density tests are not required for asphaltic concrete placed at 90 lbs/yd² (50 kg/m²) or less, 4.75 mm mix, and asphaltic concrete OGFC, PEM and mixes placed as variable depth or width leveling. Compact these courses to the Engineer’s satisfaction. Density tests will not be performed on turn-outs and driveways.

The targeted maximum Pavement Mean Air Void content for all Superpave and Stone Matrix Asphalt mixtures is 5.0 percent. Ensure that the maximum Pavement Mean Air Voids for all Superpave and Stone Matrix Asphalt mixtures does not exceed 7.0 percent. The maximum Pavement Mean Air Voids for 2 foot shoulder widening is 9.0 percent. The adjustment period for density shall be four lots or four production days, whichever is less, in order for the contractor to ensure maximum compactive effort has been achieved which will yield no more than the specified maximum allowed Mean Air Voids. If the contractor needs to adjust the mixture to improve density results, a change in the job mix formula may be requested for approval during the adjustment period so long as the following values are not exceeded:

- Coarse pay sieve ± 4%
- No. 8 (2.36 mm) sieve ± 2%
- No. 200 (75 µm) sieve ± 1%
- Asphalt Content ± 0.2%
- All value changes must still be within specification limits

If the Office of Materials and Research is satisfied that the contractor has exerted the maximum compactive effort and is not able to maintain Pavement Mean Air Voids at no more than 7.0%, the Engineer may establish a maximum target for Pavement Mean Air Voids.

Mixture placed during the adjustment period for density shall meet the requirements for a 0.90 pay factor in Table 12 of [Subsection 400.5.01.C, “Calculate Mean Pavement Air Voids.”](#) Mixture which does not meet these density requirements shall be paid for using the applicable pay factor.

If the mean air voids of the pavement placed within a lot exceeds 100% of the maximum target air voids, if established and the Engineer determines that the material need not be removed and replaced, the lot may be accepted at an adjusted unit price as determined by the Engineer.

2. Obtain Uniform Compaction

For a lot to receive a pay factor of 1.00 for compaction acceptance, the air void range cannot exceed 4 percent for new construction or 5 percent for resurfacing projects. The range is the difference between the highest and lowest acceptance test results within the affected lot. If the air void range exceeds these tolerances, apply a Pay Factor of 95%.

The 5% reduced pay factor for the compaction range does not apply in these instances:

- The mixture is placed during the adjustment period as defined in [Subsection 400.5.01.A, “Materials Produced and Placed During the Adjustment Period.”](#)
- All air void results within a given lot are less than 7.0%.

Section 400—Hot Mix Asphaltic Concrete Construction

- A lot containing two subplot or less.
- On two foot trench widening.

C. Surface Tolerance

In this Specification, pavement courses to be overlaid with an Open-Graded Friction Course or PEM are considered surface courses. All Open-Graded Friction Courses or PEM are to be evaluated after the roadway has been opened to traffic for a minimum of 5 days and a maximum of 15 days. Other asphalt paving is subject to straightedge and visual inspection and irregularity correction as shown below:

1. Visual and Straightedge Inspection

Paving is subject to visual and straightedge inspection during and after construction operations until Final Acceptance. Locate surface irregularities as follows:

- Keep a 10 ft (3 m) straightedge near the paving operation to measure surface irregularities on courses. Provide the straightedge and the labor for its use.
- Inspect the base, intermediate, and surface course surfaces with the straightedge to detect irregularities.
- Correct irregularities that exceed 3/16 in. in 10 ft (5 mm in 3 m) for base and intermediate courses, and 1/8 in. in 10 ft (3 mm in 3 m) for surface courses.

Mixture or operating techniques will be stopped if irregularities such as rippling, tearing, or pulling occur and the Engineer suspects a continuing equipment problem. Stop the paving operation and correct the problem. Correct surface course evaluations on individual Laser Road Profiler test sections, normally 1 mile (1 km) long.

2. Target Surface Smoothness

The Department will use the Laser Road Profiler method to conduct acceptance testing for surface course tolerance according to [GDT 126](#). This testing will be performed only on:

- Surface courses on Projects with mainline traveled way measuring a minimum distance of 1 mile
- Ramps more than 0.5 mile (800 m) long

Achieve the smoothest possible ride during construction. Do not exceed the target Laser Road Profiler smoothness index as shown below:

Table 7—Pavement Smoothness Requirements—New Construction

Construction Description	Smoothness Index
Asphaltic concrete OGFC and PEM on interstates and asphaltic concrete OGFC and PEM on new construction on state routes	750
Asphaltic Concrete SMA and other resurfacing on interstates, asphaltic concrete OGFC and PEM resurfacing on state routes, and new construction	825
All other resurfacing on state routes (excluding LARP, PR, airports, etc.)	900

If the target values are not achieved, immediately adjust the operations to meet the target values.

Corrective work is required if the surface smoothness exceeds the Laser Road Profiler smoothness index shown below:

Table 8—Pavement Smoothness Requirements—Corrective Work

Construction Description	Smoothness Index
Asphaltic concrete OGFC and PEM on interstates and asphaltic concrete OGFC and PEM on new construction on state routes	825
Asphaltic Concrete SMA and other resurfacing on interstates, asphaltic concrete	900

Section 400—Hot Mix Asphaltic Concrete Construction

OGFC and PEM resurfacing on state routes, and new construction	
All other resurfacing on state routes (excluding LARP, PR, airports, etc.)	1025

If surface tolerance deficiencies need correction, obtain the Engineer's approval of the methods and type mix used.

3. Bridge Approach Ride Quality

The following are subject to a ride quality test by the Department for 100 ft. (30 m) of roadway approaching each end of a bridge using the Lightweight Profiler:

- A state road with 4 lanes or more
- A 2-lane state road with a current traffic count of 2,000 vpd or more
- Locations designated on the Plans

All other bridge approaches shall meet the 1/8 in. in 10 ft (3 mm in 3 m) straightedge requirement. Test ride quality as follows:

- a. The Department will determine a profile index value according to test method [GDT 134](#).
- b. The Department will average the profile index value from the right and left wheelpath for each 100 ft (30 m) section for each lane. Keep the profile index value under 30 in/mile (475 mm/km).
- c. Meet the profile index value for the 100 ft (30 m) section of roadway up to the joint with the approach slab.
- d. Schedule the ride quality testing 5 days before needed by contacting the Office of Materials and Research. Clean and clear obstructions from the test area.
- e. Correct the sections that do not meet the ride quality criteria of this Specification. After correction, these sections are subject to retesting with the Lightweight Profiler. The Engineer shall direct the type of correction method, which may include:
 - Milling
 - Grinding
 - Removing and replacing the roadway

No additional compensation will be made.

The Department will perform ride quality testing up to two times on the bridge approaches at no cost to the Contractor. Additional profilograph testing will cost the Contractor \$500 per test.

D. Reevaluation of Lots

When lots are reevaluated as shown in [Subsection 106.03, "Samples, Tests, Cited Specifications,"](#) sampling and testing is according to [GDT 73](#). Request for reevaluation shall be made within 5 working days of notification of the lot results. The following procedures apply:

1. Mixture Acceptance

The Department will take the same number of new tests on cores taken at a location where the load sampled was placed and will use only those core results for acceptance.

The Department will use the mean of the deviations from the job mix formula for these tests to determine acceptance based on the appropriate column in the Asphalt Cement Content and Aggregate Gradation of Asphalt Concrete [Mixture Acceptance Schedule—Table 9 or 10](#).

2. Compaction Acceptance

The Department will reevaluate the lot through additional testing by cutting the same number of cores originally obtained and averaging these results with the results from the original density tests. The Department will use the average to determine acceptance according to the Compaction Acceptance Schedule in [Subsection 400.5.01.C, "Calculate Pavement Mean Air Voids"](#).

Table 9—Mixture Acceptance Schedule—Surface Mixes

Mixture Characteristics	Pay Factor	Mean of the Deviations from the Job Mix Formula							
		1 Test	2 Tests	3 Tests	4 Tests	5 Tests	6 Tests	7 Tests	8 Tests
Asphalt Cement Content (Extraction, Ignition)	1.00	0.00 - 0.70	0.00 - 0.54	0.00 - 0.46	0.00 - 0.41	0.00 - 0.38	0.00 - 0.35	0.00 - 0.32	0.00 - 0.30
	0.95	0.71 - 0.80	0.55 - 0.61	0.47 - 0.52	0.42 - 0.46	0.39 - 0.43	0.36 - 0.39	0.33 - 0.36	0.31 - 0.34
	0.90	0.81 - 0.90	0.62 - 0.68	0.53 - 0.58	0.47 - 0.51	0.44 - 0.47	0.40 - 0.45	0.37 - 0.40	0.35 - 0.37
	0.80	0.91 - 1.00	0.69 - 0.75	0.59 - 0.64	0.52 - 0.56	0.48 - 0.52	0.44 - 0.47	0.41 - 0.44	0.38 - 0.41
	0.70	1.01 - 1.19	0.76 - 0.82	0.65 - 0.69	0.57 - 0.61	0.53 - 0.56	0.48 - 0.51	0.45 - 0.47	0.42 - 0.44
	0.50	1.20 - 1.40	0.83 - 0.85	0.70 - 0.72	0.62 - 0.64	0.57 - 0.59	0.52 - 0.55	0.48 - 0.51	0.45 - 0.48
3/8 in. (9.5 mm) Sieve (12.5 mm OGFC, 12.5 mm PEM, 12.5 mm Superpave)	1.00	0.00 - 0.9	0.00 - 6.6	0.00 - 5.6	0.00 - 5.0	0.00 - 4.6	0.00 - 4.2	0.00 - 3.9	0.00 - 3.6
	0.98	9.1 - 10.0	6.7 - 7.5	5.7 - 6.3	5.1 - 5.6	4.7 - 5.2	4.3 - 4.7	4.0 - 4.4	3.7 - 4.1
	0.95	10.1 - 11.9	7.6 - 8.4	6.4 - 7.0	5.7 - 6.3	5.3 - 5.8	4.8 - 5.3	4.5 - 5.0	4.2 - 4.6
	0.90	12.0 - 13.0	8.5 - 9.3	7.1 - 7.7	6.4 - 6.9	5.9 - 6.3	5.4 - 5.8	5.1 - 5.4	4.7 - 5.0
	0.85	13.1 - 14.0	9.4 - 10.2	7.8 - 8.6	7.0 - 7.6	6.4 - 6.9	5.9 - 6.3	5.5 - 5.9	5.1 - 5.5
	0.80	14.1 - 14.5	10.3 - 10.5	8.7 - 8.9	7.7 - 8.0	7.0 - 7.5	6.4 - 6.8	6.0 - 6.4	5.6 - 6.0
3/8 in. (9.5 mm) Sieve (12.5 mm SMA)	1.00	0.0 - 6.8	0.00 - 5.0	0.00 - 4.2	0.00 - 3.8	0.00 - 3.4	0.00 - 3.2	0.00 - 2.9	0.00 - 2.7
	0.98	6.9 - 7.5	5.1 - 5.6	4.6 - 4.7	3.9 - 4.2	3.5 - 3.9	3.3 - 3.5	3.0 - 3.3	2.8 - 3.1
	0.95	7.6 - 8.9	5.7 - 6.3	4.8 - 5.2	4.3 - 4.7	4.0 - 4.4	3.6 - 4.0	3.4 - 3.8	3.2 - 3.4
	0.90	9.0 - 9.8	6.4 - 7.0	5.3 - 5.8	4.8 - 5.2	4.5 - 4.8	4.1 - 4.4	3.9 - 4.1	3.5 - 3.8
	0.85	9.9 - 10.5	7.1 - 7.6	5.9 - 6.4	5.3 - 5.7	4.9 - 5.2	4.5 - 4.7	4.2 - 4.4	3.9 - 4.1
	0.80	10.6 - 10.9	7.7 - 7.9	6.5 - 6.7	5.8 - 6.0	5.3 - 5.6	4.8 - 5.1	4.5 - 4.8	4.2 - 4.5
No. 4 (4.75 mm) Sieve (9.5 mm OGFC, 9.5 mm Superpave)	1.00	0.00 - 9.0	0.00 - 6.7	0.00 - 5.7	0.00 - 5.2	0.00 - 4.8	0.00 - 4.4	0.00 - 4.1	0.00 - 3.8
	0.98	9.1 - 10.0	6.8 - 7.6	5.8 - 6.3	5.3 - 5.8	4.9 - 5.4	4.5 - 4.9	4.2 - 4.6	3.9 - 4.3
	0.95	10.1 - 11.9	7.7 - 8.5	6.4 - 6.9	5.9 - 6.4	5.5 - 5.9	5.0 - 5.4	4.7 - 5.0	4.4 - 4.7
	0.90	12.0 - 13.0	8.6 - 9.4	7.0 - 7.5	6.5 - 7.0	6.0 - 6.5	5.5 - 5.9	5.1 - 5.5	4.8 - 5.1
	0.85	13.1 - 14.0	9.5 - 10.2	7.6 - 8.0	7.1 - 7.6	6.6 - 7.0	6.0 - 6.4	5.6 - 5.9	5.2 - 5.5
	0.80	14.1 - 14.5	10.3 - 10.5	8.1 - 8.3	7.7 - 8.0	7.1 - 7.5	6.5 - 6.9	6.0 - 6.4	5.6 - 5.9
No. 4 (4.75 mm) Sieve	1.00	0.00 - 6.8	0.00 - 5.0	0.00 - 4.3	0.00 - 3.9	0.00 - 3.6	0.00 - 3.3	0.00 - 3.1	0.00 - 2.8

Section 400—Hot Mix Asphaltic Concrete Construction

Mixture Characteristics	Pay Factor	Mean of the Deviations from the Job Mix Formula							
		1 Test	2 Tests	3 Tests	4 Tests	5 Tests	6 Tests	7 Tests	8 Tests
(9.5 mm SMA)	0.98	6.9 - 7.5	5.1 - 5.7	4.4 - 4.7	4.0 - 4.4	3.7 - 4.0	3.4 - 3.7	3.2 - 3.4	2.9 - 3.2
	0.95	7.6 - 8.9	5.8 - 6.4	4.8 - 5.2	4.5 - 4.8	4.1 - 4.4	3.8 - 4.0	3.5 - 3.8	3.3 - 3.5
	0.90	9.0 - 9.8	6.5 - 7.0	5.3 - 5.6	4.9 - 5.2	4.5 - 4.9	4.1 - 4.4	3.9 - 4.1	3.6 - 3.8
	0.85	9.9 - 10.5	7.1 - 7.7	5.7 - 6.0	5.3 - 5.7	5.0 - 5.2	4.3 - 4.8	4.2 - 4.4	3.9 - 4.1
	0.80	10.6 - 10.9	7.8 - 7.9	6.1 - 6.2	5.8 - 6.0	5.3 - 5.6	4.9 - 5.2	4.5 - 4.8	4.2 - 4.4
No. 8 (2.36 mm) Sieve (OGFC, PEM, Superpave and 4.75 mm mixes)	1.00	0.00 - 7.0	0.00 - 5.6	0.00 - 4.8	0.00 - 4.3	0.00 - 4.0	0.00 - 3.6	0.00 - 3.4	0.00 - 3.2
	0.98	7.1 - 8.0	5.7 - 6.3	4.9 - 5.4	4.4 - 4.8	4.1 - 4.5	3.7 - 4.1	3.5 - 3.8	3.3 - 3.6
	0.95	8.1 - 9.0	6.4 - 7.0	5.5 - 6.0	4.9 - 5.3	4.6 - 4.9	4.2 - 4.5	3.9 - 4.2	3.7 - 3.9
	0.90	9.1 - 10.9	7.1 - 7.7	6.1 - 6.6	5.4 - 5.8	5.0 - 5.4	4.6 - 4.9	4.3 - 4.6	4.0 - 4.3
	0.85	11.0 - 12.0	7.8 - 8.5	6.7 - 7.2	5.9 - 6.4	5.5 - 5.8	5.0 - 5.3	4.7 - 5.0	4.4 - 4.6
	0.75	12.1 - 12.5	8.6 - 8.8	7.3 - 7.5	6.5 - 6.8	5.9 - 6.3	5.4 - 5.7	5.1 - 5.3	4.7 - 4.9
No. 8 (2.36 mm) Sieve (12.5 mm SMA, 9.5 mm SMA)	1.00	0.00 - 5.3	0.00 - 4.2	0.00 - 3.6	0.00 - 3.2	0.00 - 3.0	0.00 - 2.7	0.00 - 2.6	0.00 - 2.4
	0.98	5.4 - 6.0	4.3 - 4.7	3.7 - 4.0	3.3 - 3.6	3.1 - 3.4	2.8 - 3.1	2.7 - 2.9	2.5 - 2.7
	0.95	6.1 - 6.8	4.8 - 5.3	4.1 - 4.5	3.7 - 4.0	3.5 - 3.7	3.2 - 3.4	3.0 - 3.2	2.8 - 2.9
	0.90	6.9 - 8.2	5.4 - 5.8	5.6 - 5.0	4.1 - 4.5	3.8 - 4.0	3.5 - 3.7	3.3 - 3.5	3.0 - 3.2
	0.85	8.3 - 9.0	5.9 - 6.4	5.1 - 5.4	4.6 - 4.8	4.1 - 4.4	3.8 - 4.0	3.6 - 3.8	3.3 - 3.4
	0.75	9.1 - 9.4	6.5 - 6.6	5.5 - 5.0	4.9 - 5.1	4.5 - 4.7	4.1 - 4.3	3.9 - 4.0	3.5 - 3.7
No. 8 (2.36 mm) Sieve for OGFC and PEM mixes: When the mean of the deviations from the Job Mix Formula for a particular lot exceeds the tolerance for a 1.00 pay factor in the appropriate column, the lot will be paid for at 0.50 of the Contract Price.									

Table 10—Mixture Acceptance Schedule—Subsurface Mixes

Mixture Characteristics	Pay Factor	Mean of the Deviations from the Job Mix Formula							
		1 Test	2 Tests	3 Tests	4 Tests	5 Tests	6 Tests	7 Tests	8 Tests
Asphalt Cement Content (Extraction, Ignition)	1.00	0.00 - 0.80	0.00 - 0.61	0.00 - 0.52	0.00 - 0.46	0.00 - 0.43	0.00 - 0.39	0.00 - 0.36	0.00 - 0.34
	0.95	0.81 - 0.90	0.62 - 0.68	0.53 - 0.58	0.47 - 0.51	0.44 - 0.47	0.40 - 0.43	0.37 - 0.40	0.35 - 0.37
	0.90	0.91 - 1.00	0.69 - 0.75	0.59 - 0.64	0.52 - 0.56	0.48 - 0.52	0.44 - 0.47	0.41 - 0.44	0.38 - 0.41
	0.80	1.01 - 1.19	0.76 - 0.82	0.65 - 0.69	0.57 - 0.61	0.53 - 0.56	0.48 - 0.51	0.45 - 0.47	0.42 - 0.44
	0.70	1.20 - 1.40	0.83 - 0.85	0.70 - 0.72	0.62 - 0.64	0.57 - 0.59	0.52 - 0.55	0.48 - 0.51	0.45 - 0.48
	0.50	1.41 - 1.60	0.86 - 0.88	0.73 - 0.75	0.65 - 0.67	0.60 - 0.63	0.56 - 0.60	0.52 - 0.56	0.49 - 0.52
1/2 in. (12.5 mm) Sieve (25 mm Superpave)	1.00	0.00 - 12.9	0.00 - 8.1	0.00 - 6.9	0.00 - 6.1	0.00 - 5.5	0.00 - 5.0	0.00 - 4.7	0.00 - 4.4
	0.98	13.0 - 14.0	8.2 - 9.1	7.0 - 7.7	6.2 - 6.8	5.6 - 6.1	5.1 - 5.6	4.8 - 5.2	4.5 - 4.9
	0.95	14.1 - 15.0	9.2 - 10.1	7.8 - 8.5	6.9 - 7.5	6.2 - 6.7	5.7 - 6.1	5.3 - 5.7	5.0 - 5.4
	0.90	15.1 - 16.0	10.2 - 11.1	8.6 - 9.3	7.6 - 8.2	6.8 - 7.4	6.2 - 6.7	5.8 - 6.3	5.5 - 5.9
	0.85	16.1 - 17.0	11.2 - 11.5	9.4 - 9.6	8.3 - 8.6	7.5 - 7.8	6.8 - 7.0	6.4 - 6.5	6.0 - 6.1
	0.80	17.1 - 18.0	11.6 - 11.9	9.7 - 9.9	8.7 - 9.0	7.9 - 8.1	7.1 - 7.3	6.6 - 6.8	6.2 - 6.4
1/2 in. (12.5 mm) Sieve (19 mm SMA)	1.00	0.00 - 9.7	0.00 - 6.0	0.00 - 5.2	0.00 - 4.6	0.00 - 4.1	0.00 - 3.8	0.00 - 3.5	0.00 - 3.3
	0.98	9.8 - 10.5	6.2 - 6.8	5.3 - 5.8	4.7 - 5.1	4.2 - 4.6	3.9 - 4.2	3.6 - 3.9	3.4 - 3.7
	0.95	10.6 - 11.2	6.9 - 7.8	5.9 - 6.4	5.2 - 5.6	4.7 - 5.0	4.3 - 4.6	4.0 - 4.3	3.8 - 4.0
	0.90	11.3 - 12.0	7.9 - 8.3	6.5 - 7.0	5.7 - 6.1	5.1 - 5.6	4.7 - 5.0	4.4 - 4.7	4.1 - 4.4
	0.85	12.1 - 12.8	8.4 - 8.6	7.1 - 7.2	6.2 - 6.5	5.7 - 5.9	5.1 - 5.3	4.8 - 4.9	4.5 - 5.6
	0.80	12.9 - 13.5	8.7 - 8.9	7.3 - 7.4	6.6 - 6.8	6.0 - 6.1	5.4 - 5.5	5.0 - 5.1	4.7 - 4.8
3/8 in. (9.5 mm) Sieve (19 mm Superpave, 12.5 mm Superpave)	1.00	0.00 - 10.0	0.00 - 7.5	0.00 - 6.3	0.00 - 5.6	0.00 - 5.2	0.00 - 4.7	0.00 - 4.4	0.00 - 4.1
	0.98	10.1 - 11.9	7.6 - 8.4	6.4 - 7.0	5.7 - 6.3	5.3 - 5.8	4.8 - 5.3	4.5 - 5.0	4.2 - 4.6
	0.95	12.0 - 13.0	8.5 - 9.3	7.1 - 7.7	6.4 - 6.9	5.9 - 6.3	5.4 - 5.8	5.1 - 5.4	4.7 - 5.0
	0.90	13.1 - 14.0	9.4 - 10.2	7.8 - 8.6	7.0 - 7.6	6.4 - 6.9	5.9 - 6.3	5.5 - 5.9	5.1 - 5.5
	0.85	14.1 - 14.5	10.3 - 10.5	8.7 - 8.9	7.7 - 8.0	7.0 - 7.5	6.4 - 6.8	6.0 - 6.4	5.6 - 6.0
	0.80	14.6 - 15.0	10.6 - 10.8	9.0 - 9.2	8.1 - 8.4	7.6 - 7.8	6.9 - 7.3	6.5 - 6.8	6.1 - 6.5
No. 4 (4.75 mm) Sieve	1.00	0.00 - 10.0	0.00 - 7.6	0.00 - 6.3	0.00 - 5.8	0.00 - 5.4	0.00 - 4.9	0.00 - 4.6	0.00 - 4.3

Section 400—Hot Mix Asphaltic Concrete Construction

Mixture Characteristics	Pay Factor	Mean of the Deviations from the Job Mix Formula							
		1 Test	2 Tests	3 Tests	4 Tests	5 Tests	6 Tests	7 Tests	8 Tests
(9.5 mm Superpave)	0.98	10.1 - 11.9	7.7 - 8.5	6.4 - 6.9	5.9 - 6.4	5.5 - 5.9	5.0 - 5.4	4.7 - 5.0	4.4 - 4.7
	0.95	12.0 - 13.0	8.6 - 9.4	7.0 - 7.5	6.5 - 7.0	6.0 - 6.5	5.5 - 5.9	5.1 - 5.5	4.8 - 5.1
	0.90	13.1 - 14.0	9.5 - 10.2	7.6 - 8.0	7.1 - 7.6	6.6 - 7.0	6.0 - 6.4	5.6 - 5.9	5.2 - 5.5
	0.85	14.1 - 14.5	10.3 - 10.5	8.1 - 8.3	7.7 - 8.0	7.1 - 7.5	6.5 - 6.9	6.0 - 6.4	5.6 - 5.9
	0.80	14.6 - 15.0	10.6 - 10.8	8.4 - 8.6	8.1 - 8.4	7.6 - 8.0	7.0 - 7.4	6.5 - 6.8	6.0 - 6.3
No. 8 (2.36 mm) Sieve (All mixes except SMA)	1.00	0.00 - 8.0	0.00 - 6.3	0.00 - 5.4	0.00 - 4.8	0.00 - 4.5	0.00 - 4.1	0.00 - 3.8	0.00 - 3.6
	0.98	8.1 - 9.0	6.4 - 7.0	5.5 - 6.0	4.9 - 5.3	4.6 - 4.9	4.2 - 4.5	3.9 - 4.2	3.7 - 3.9
	0.95	9.1 - 10.0	7.1 - 7.7	6.1 - 6.6	5.4 - 5.8	5.0 - 5.4	4.6 - 4.9	4.3 - 4.6	4.0 - 4.3
	0.90	10.1 - 11.9	7.8 - 8.5	6.7 - 7.2	5.9 - 6.4	5.5 - 5.8	5.0 - 5.3	4.7 - 5.0	4.4 - 4.6
	0.85	12.0 - 13.0	8.6 - 8.8	7.3 - 7.5	6.5 - 6.8	5.9 - 6.3	5.4 - 5.7	5.1 - 5.3	4.7 - 4.9
	0.75	13.1 - 14.0	8.9 - 9.1	7.6 - 7.8	6.9 - 7.2	6.4 - 6.6	5.8 - 6.1	5.4 - 5.7	5.0 - 5.3
No. 8 (2.36 mm) Sieve (19 mm SMA)	1.00	0.00 - 6.0	0.00 - 4.7	0.00 - 4.1	0.00 - 3.6	0.00 - 3.4	0.00 - 3.1	0.00 - 2.9	0.00 - 2.4
	0.98	6.1 - 6.8	4.8 - 5.2	4.2 - 4.5	3.7 - 4.0	3.5 - 3.7	3.2 - 3.4	3.0 - 3.2	2.8 - 2.9
	0.95	6.9 - 7.5	5.3 - 5.8	4.6 - 5.0	4.1 - 4.4	3.8 - 4.0	3.5 - 3.7	3.3 - 3.5	3.0 - 3.2
	0.90	7.6 - 8.9	5.9 - 6.4	5.1 - 5.4	4.5 - 4.8	4.1 - 4.4	3.8 - 4.0	3.6 - 3.8	3.3 - 3.5
	0.85	9.0 - 9.8	6.5 - 6.6	5.5 - 5.6	4.9 - 5.1	4.5 - 4.7	4.1 - 4.3	3.9 - 4.0	3.6 - 3.7
	0.75	9.9 - 10.5	6.7 - 6.8	5.7 - 5.9	5.2 - 5.4	4.8 - 5.0	4.4 - 4.6	4.1 - 4.3	3.8 - 4.0

E. Segregated Mixture

Prevent mixture placement that yields a segregated mat by following production, storage, loading, placing, and handling procedures. Also, make needed plant modifications and provide necessary auxiliary equipment. (See [Subsection 400.1.01, "Definitions."](#))

If the mixture is segregated in the finished mat, the Department will take actions based on the degree of segregation. The actions are described below.

1. Unquestionably Unacceptable Segregation

When the Engineer determines that the segregation in the finished mat is unquestionably unacceptable, follow these measures:

- a. Suspend Work and require the Contractor to take positive corrective action. The Department will evaluate the segregated areas to determine the extent of the corrective work to the in-place mat as follows:
 - Perform extraction and gradation analysis by taking 6 in (150 mm) cores from typical, visually unacceptable segregated areas.
 - Determine the corrective work according to [Subsection 400.3.06.E.3](#).
- b. Require the Contractor to submit a written plan of measures and actions to prevent further segregation. Work will not continue until the plan is submitted to and approved by the Department.
- c. When work resumes, place a test section not to exceed 500 tons (500 Mg) of the affected mixture for the Department to evaluate. If a few loads show that corrective actions were not adequate, follow the measures above beginning with step 1.a. above. If the problem is solved, Work may continue.

2. Unacceptable Segregation Suspected

When the Engineer observes segregation in the finished mat and suspects that it may be unacceptable, follow these measures:

- a. Allow work to continue at Contractor's risk.
- b. Require Contractor to immediately and continually adjust operation until the visually apparent segregated areas are eliminated from the finished mat. The Department will immediately investigate to determine the severity of the apparent segregation as follows:
 - Take 6 in (150 mm) cores from typical areas of suspect segregation.
 - Test the cores for compliance with the mixture control tolerances in [Section 828](#).

When these tolerances are exceeded, suspend work for corrective action as outlined in [Subsection 400.3.06.E.3](#).

3. Corrective Work

- a. Remove and replace (at the Contractor's expense) any segregated area where the gradation on the control sieves is found to vary 10 percent or more from the approved job mix formula, the asphalt cement varies 1.0% or more from the approved job mix formula, or if in-place air voids exceed 13.5% based on [GDT 39](#). The control sieves for each mix type are shown in [Subsection 400.5.01.B "Determine Lot Acceptance."](#)
- b. Subsurface mixes. For subsurface mixes, limit removal and replacement to the full lane width and no less than 10 ft. (3 m) long and as approved by the Engineer.
- c. Surface Mixes. For surface mixes, ensure that removal and replacement is not less than the full width of the affected lane and no less than the length of the affected areas as determined by the Engineer.

Surface tolerance requirements apply to the corrected areas for both subsurface and surface mixes.

400.3.07 Contractor Warranty and Maintenance

A. Contractor's Record

Maintain a dated, written record of the most recent plant calibration. Keep this record available for the Engineer's inspection at all times. Maintain records in the form of:

- Graphs
- Tables
- Charts

Section 400—Hot Mix Asphaltic Concrete Construction

- Mechanically prepared data

400.4 Measurement

Thickness and spread rate tolerances for the various mixtures are specified in [Subsection 400.4.A.2.b, Table 11, Thickness and Spread Rate Tolerance at Any Given Location](#). These tolerances are applied as outlined below:

A. Hot Mix Asphaltic Concrete Paid for by Weight

1. Plans Designate a Spread Rate

- a. Thickness Determinations. Thickness determinations are not required when the Plans designate a spread rate per square yard (meter).

If the spread rate exceeds the upper limits outlined in the [Subsection 400.4.A.2.b, Table 11, “Thickness and Spread Rate Tolerance at Any Given Location”](#), the mix in excess will not be paid for.

If the rate of spread is less than the lower limit, correct the deficient course by overlaying the entire lot.

The mixture used for correcting deficient areas is paid for at the Contract Unit Price of the course being corrected and is subject to the [Mixture Acceptance Schedule—Table 9 or 10](#).

- b. Recalculate the Total Spread Rate. After the deficient hot mix course has been corrected, the total spread rate for that lot is recalculated, and mix in excess of the upper tolerance limit as outlined in the [Subsection 400.4.A.2.b, Table 11, “Thickness and Spread Rate Tolerance at Any Given Location”](#) is not paid for.

The quantity of material placed on irregular areas such as driveways, turnouts, intersections, feather edge section, etc., is deducted from the final spread determination for each lot.

2. Plans Designate Thickness

If the average thickness exceeds the tolerances specified in the [Subsection 400.4.A.2.b, Table 11, “Thickness and Spread Rate Tolerance at Any Given Location”](#), the Engineer shall take cores to determine the area of excess thickness. Excess quantity will not be paid for.

If the average thickness is deficient by more than the tolerances specified in the Thickness and Spread Rate Tolerance at Any Given Location table below, the Engineer shall take additional cores to determine the area of deficient thickness. Correct areas with thickness deficiencies as follows:

- a. Overlay the deficient area with the same mixture type being corrected or with an approved surface mixture. The overlay shall extend for a minimum of 300 ft (90 m) for the full width of the course.
- b. Ensure that the corrected surface course complies with [Subsection 400.3.06.C.1, “Visual and Straightedge Inspection.”](#) The mixture required to correct a deficient area is paid for at the Contract Unit Price of the course being corrected.

The mixture is subject to the [Mixture Acceptance Schedule—Table 9 or 10](#). The quantity of the additional mixture shall not exceed the required calculated quantity used to increase the average thickness of the overlaid section to the maximum tolerance allowed under the following table.

Table 11—Thickness and Spread Rate Tolerance at Any Given Location

Course	Thickness Specified	Spread Rate Specified
Asphaltic concrete base course	± 0.5 in (±13 mm)	+40 lbs, -50 lbs (+20 kg, -30 kg)
Intermediate and/or wearing course	± 0.25 in (± 6 mm)	+20 lbs, -25 lbs (+10 kg, -15 kg)
Overall of any combination of 1 and 2	± 0.5 in (±13 mm)	+40 lbs, -50 lbs (+20 kg, -30 kg)

Note 1: For asphaltic concrete 9.5 mm OGFC and 12.5 mm OGFC, control the spread rate per lot within 5 lbs/yd² (3 kg/m²) of the designated spread rate. For asphaltic concrete 12.5 mm PEM, control the spread rate per lot within 10 lbs/yd² (6 kg/m²) of the designated spread rate.

Section 400—Hot Mix Asphaltic Concrete Construction

Note 2: Thickness and spread rate tolerances are provided to allow normal variations within a given lot. Do not continuously operate at a thickness of spread rate not specified.

When the Plans specify a thickness, the Engineer may take as many cores as necessary to determine the average thickness of the intermediate or surface course. The Engineer shall take a minimum of one core per 1,000 ft (300 m) per two lanes of roadway. Thickness will be determined by average measurements of each core according to [GDT 42](#).

If the average exceeds the tolerances specified in the [Subsection 400.4.A.2.b, Table 11, “Thickness and Spread Rate Tolerance at Any Given Location”](#), additional cores will be taken to determine the area of excess thickness and excess tonnage will not be paid for.

B. Hot Mix Asphaltic Concrete Paid for by Square Yard (Meter)

1. The thickness of the base course or the intermediate or surface course will be determined by the Department by cutting cores and the thickness will be determined by averaging the measurements of each core.
2. If any measurement is deficient in thickness more than the tolerances given in the table above, additional cores will be taken by the Department to determine the area of thickness deficiency. Correct thickness deficiency areas as follows:
 - a. Overlay the deficient area with the same type mixtures being corrected or with surface mixture. Extend the overlay at least 300 ft (90 m) for the full width of the course.
 - b. Ensure that the corrected surface course complies with [Subsection 400.3.06.C.1, Visual and Straightedge Inspection](#) .
 - c. The mixture is subject to the [Mixture Acceptance Schedule—Table 9 or 10](#).
3. No extra payment is made for mixtures used for correction.
4. No extra payment is made for thickness in excess of that specified.

NOTE: Thickness tolerances are provided to allow normal variations within a given lot. Do not continuously operate at a thickness not specified.

C. Asphaltic Concrete

Hot mix asphaltic concrete, complete in place and accepted, is measured in tons (megagrams) or square yards (meters) as indicated in the Proposal. If payment is by the ton (megagram), the actual weight is determined by weighing each loaded vehicle on the required motor truck scale as the material is hauled to the roadway, or by using recorded weights if a digital recording device is used.

The weight measured includes all materials. No deductions are made for the weight of the individual ingredients. The actual weight is the pay weight except when the aggregates used have a combined bulk specific gravity greater than 2.75. In this case the pay weight is determined according to the following formula:

$$T1 = T \times \left\{ \frac{\% AC + \left(\frac{\% Aggregate \times 2.75}{combined\ bulk\ Specific\ Gravity} \right) + \% Y}{100} \right\}$$

Where:

T1	Pay weight, tonnage (Mg)
T=	Actual weight

Section 400—Hot Mix Asphaltic Concrete Construction

% AC=	Percent asphalt cement by weight of total mixture
% Aggregate =	Percent aggregate by weight of total mixture
Combined Bulk Sp. Gr.=	Calculated combined bulk specific gravity of various mineral aggregates used in the mixture
% Y=	Percent hydrated lime by weight of mineral aggregate

D. Bituminous Material

Bituminous material is not measured for separate payment.

E. Hydrated Lime

When hydrated lime is used as an anti-stripping additive, it is not measured for separate payment.

F. Field Laboratory

The field laboratory required in this Specification is not measured for separate payment.

G. Asphaltic Concrete Leveling

Payment of hot mix asphaltic concrete leveling, regardless of the type mix, is full compensation for furnishing materials, bituminous materials, and hydrated lime (when required) for patching and repair of minor defects, surface preparation, cleaning, hauling, mixing, spreading, and rolling.

Mixture for leveling courses is subject to the acceptance schedule as stated in [Subsection 400.3.06.A](#) and [Subsection 400.3.06.B](#).

H. Asphaltic Concrete Patching

Hot mix asphaltic concrete patching, regardless of the type mix, is paid for at the Contract Unit Price per ton (Megagram), complete in place and accepted. Payment is full compensation for:

- Furnishing materials such as bituminous material and hydrated lime (when required)
- Preparing surface to be patched
- Cutting areas to be patched, trimmed, and cleaned
- Hauling, mixing, placing, and compacting the materials

400.4.01 Limits

When the asphaltic concrete is paid for by the square yard (meter) and multiple lifts are used, the number and thickness of the lifts are subject to the Engineer's approval and are used to prorate the pay factor for the affected roadway section.

400.5 Payment

This item will be paid for under CONSTRUCTION COMPLETE.

Includes furnishing and placing materials including asphalt cement, hydrated lime when required, approved additives, and for cleaning and repairing, preparing surfaces, hauling, mixing, spreading, rolling, and performing other operations to complete the Contract Item.

400.5.01 Adjustments

A. Materials Produced and Placed During the Adjustment Period

An adjustment period is allowed at the start of mixing operations for each type of mix placed on the Contract except for Asphaltic Concrete OGFC or PEM. The adjustment period is provided to adjust or correct the mix and to establish the construction procedures and sequence of operations.

The adjustment period consists of the tons (megagrams) of the affected mix produced and placed on the first day of operation. If this quantity is less than 500 tons (500 Mg), the Engineer may combine the tons (megagrams) produced and placed on the first day of operation with the tons (megagrams) produced and placed on the next production day of the affected mix for the adjustment period.

Section 400—Hot Mix Asphaltic Concrete Construction

The material produced and placed during the mixture adjustment period is one lot. If the mix is adjusted during this period, a new lot may be necessary, but a new adjustment period will not be permitted.

This material shall be paid for at 100 percent of the Contract Unit Price provided it meets the minimum requirements for a 1.00 pay factor for asphalt cement content and a 0.90 pay factor for gradation in the [Mixture Acceptance Schedule—Table 9 or 10](#).

If the material placed during the adjustment period fails to meet the above requirements, it will be paid for using the applicable acceptance schedule. However, when mixture used for leveling at a spread rate of 90 lbs/yd² (50 kg/m²) or less is also used for the surface mix at a spread rate greater than 90 lbs/yd² (50 kg/m²), an additional adjustment period will be allowed for compaction only. This material will be paid for at a 1.00 pay factor provided it:

- Meets the minimum requirements for a 1.00 pay factor in the Mixture Acceptance Schedule—Table 9 or 10 for both asphalt content and gradation.
- Meets the minimum requirements for a 0.90 pay factor in Table 12 of [Subsection 400.5.01C, “Calculate Mean Pavement Air Voids.”](#)

Mixture which does not meet these requirements shall be paid for using the applicable acceptance schedule.

B. Determine Lot Acceptance

Pay factor adjustments are based on control sieves and asphalt cement content. The control sieves used in the mixture acceptance schedule for the various types of mix are indicated below:

Control Sieves Used in the Mixture Acceptance Schedule	
Asphaltic concrete 25 mm Superpave	1/2 in., No. 8 (12.5 mm, 2.36 mm) sieves and asphalt cement
Asphaltic concrete 19 mm SMA	1/2 in., No. 8 (12.5 mm, 2.36 mm) sieves and asphalt cement
Asphaltic concrete 19 mm Superpave	3/8 in., No. 8 (9.5 mm, 2.36 mm) sieves and asphalt cement
Asphaltic concrete 12.5 mm Superpave	3/8 in., No. 8 (9.5 mm, 2.36 mm) sieves and asphalt cement
Asphaltic concrete 12.5 mm SMA	3/8 in., No. 8 (9.5 mm, 2.36 mm) sieves and asphalt cement
Asphaltic concrete 12.5 mm PEM	3/8 in., No. 8 (9.5 mm, 2.36 mm) sieves and asphalt cement
Asphaltic concrete 12.5 mm OGFC	3/8 in., No. 8 (9.5 mm, 2.36 mm) sieves and asphalt cement
Asphaltic concrete 9.5 mm Superpave	No. 4, No. 8 (4.75 mm, 2.36 mm) sieves and asphalt cement
Asphaltic concrete 9.5 mm SMA	No. 4, No. 8 (4.75 mm, 2.36 mm) sieves and asphalt cement
Asphaltic concrete 9.5 mm OGFC	No. 4, No. 8 (4.75 mm, 2.36 mm) sieves and asphalt cement
Asphaltic concrete 4.75 mm Mix	No. 8 (2.36 mm) sieve and asphalt cement

For projects which do not have milling quantities established as a Pay Item, the Department will pay for 12.5 mm OGFC and PEM placed on ramps and end of project transitions under the appropriate mixture pay item, but the mix shall be subject to the same gradation and control sieve requirements as asphaltic concrete 9.5 mm OGFC. Add polymer-modified bituminous material, hydrated lime, and stabilizing fiber to this mix.

The Department will perform the following tasks:

1. Using the [Mixture Acceptance Schedule—Table 9 or 10](#), determine the mean of the deviations from the job mix formula per test results per lot.
2. Determine this mean by averaging the actual numeric value of the individual deviations from the job mix formula; disregard whether the deviations are positive or negative amounts.
3. Use the Asphalt Cement Content and Aggregate Gradation of Asphalt Concrete [Mixture Acceptance Schedule—Table 9](#) to determine acceptance of surface mixes and the [Mixture Acceptance Schedule—Table 10](#) to determine acceptance of subsurface mixes.

On Contracts involving 1,000 tons (1000 Mg) or less of asphaltic concrete, the mixture is accepted for 100 percent payment of the asphaltic concrete Unit Price provided it meets the following:

Section 400—Hot Mix Asphaltic Concrete Construction

1. Minimum requirements for a 1.00 pay factor for asphalt cement content and a 0.90 pay factor for gradation in the applicable [Mixture Acceptance Schedule—Table 9 or 10](#).
2. Minimum requirements for a 0.90 pay factor in Table 12 of [Subsection 400.5.01C, “Calculate Pavement Mean Air Voids](#).

If the material placed on Contracts involving 1,000 tons (1000 Mg) or less of asphaltic concrete does not meet the above requirements, the material will be paid for using the applicable acceptance schedule.

C. Calculate Pavement Mean Air Voids

The Department will determine the percent of maximum air voids for each lot by dividing the pavement mean air voids by the maximum pavement mean air voids acceptable.

The Department will determine the payment for each lot by multiplying the Contract Unit Price by the adjusted pay factor shown in the following Air Voids Acceptance schedule:

Table 12 - Air Voids Acceptance Schedule

Pay Factor	Percent of Maximum Air Voids (Lot Average of Tests)	Percent of Maximum Air Voids (Lot Average all Tests) (for Reevaluations)
1.00	≤100	≤100
0.97	100.1 — 105	100.1 — 104
0.95	105.1 — 112	104.1— 109
0.90	112.1 — 124	109.1 — 118
0.80	124.1 — 149	118.1 — 136
0.70	149.1 —172	136.1 — 153
0.50	172.1 — 191	153.1 — 166

When the range tolerance is exceeded, the Department will apply a pay factor of 0.95 as described in [Subsection 400.3.06.B.2](#).

D. Asphaltic Concrete For Temporary Detours

Hot mix asphaltic concrete placed on temporary detours that will not remain in place as part of the permanent pavement does not require hydrated lime. Hot mix used for this purpose is paid for at an adjusted Contract Price.

Where the Contract Price of the asphaltic concrete for permanent pavement is let by the ton (megagram), the Contract Price for the asphaltic concrete placed on temporary detours is adjusted by subtracting \$0.75/ton (\$0.85/mg) of mix used.

Where the Contract price of the mix in the permanent pavement is based on the square yard (meter), obtain the adjusted price for the same mix used on the temporary detour by subtracting \$0.04/yd² (\$0.05/ m²) per 1-in (25-mm) plan depth.

Further price adjustments required in [Subsection 400.3.06, “Quality Acceptance,”](#) are based on the appropriate adjusted Contract Price for mix used in the temporary detour work.

E. Determine Lot Payment

Determine the lot payment as follows:

1. When one of the pay factors for a specific acceptance lot is less than 1.0, determine the payment for the lot by multiplying the Contract Unit Price by the adjusted pay factor.
2. When two or more pay factors for a specific acceptance lot are less than 1.0, determine the adjusted payment by multiplying the Contract Unit Price by the lowest pay factor.

If the mean of the deviations from the job mix formula of the tests for a sieve or asphalt cement content exceeds the tolerances established in the [Mixture Acceptance Schedule—Table 9 or 10](#) and if the Engineer determines that the material need not be removed and replaced, the lot may be accepted at an adjusted unit price as determined by the

Section 400—Hot Mix Asphaltic Concrete Construction

Engineer. If the pavement mean air voids exceed the tolerances established in the [Air Voids Acceptance Schedule – Table 12](#), remove and replace the materials at the Contractor’s expense.

If the Engineer determines that the material is not acceptable to leave in place, remove and replace the materials at the Contractor’s expense.

F. Asphalt Cement Price Adjustment

1. **Formula:** The Asphalt Cement Price Adjustment will be computed on a *monthly* basis in accordance with the following:

PA = Price Adjustment.

APM= the “Monthly Asphalt Cement Price” for the month the hot mix asphalt is placed.

APL = the “Monthly Asphalt Cement Price” for the month which the project was let.

TMT = Total Monthly Tonnage of asphalt cement computed by the Engineer based on the Hot Mix Asphaltic Concrete of the various types per ton (megagram) certified for payment.

- a. If the asphalt cement price for the month is *greater* than the asphalt cement price for the month in which the project was let:

$$PA = [((APM-APL)/APL) - 0.05] \times TMT \times APL$$

- b. If the asphalt cement price for the month is *less* than the asphalt cement price for the month in which the project was let:

$$PA = [((APM-APL)/APL) + 0.05] \times TMT \times APL$$

2. **Price Adjustment Triggers:** No price adjustment shall be made on any hot mix asphalt placed on projects with less than 366 calendar days from the Contract Letting Date to the specified completion date. If the Original Contract contains 366 calendar days or more the Price Adjustment Trigger shall be made for any hot mix asphalt placed from the Contract Letting Date to the specified completion date. A price adjustment shall not be made until the APM is greater than 5% above or below the APL.
3. **“Monthly Asphalt Cement Price”:** The Department will determine and publish a “Monthly Asphalt Cement Price” based on the following formulas:

$$\text{Monthly Asphalt Cement Price} = (50\% \times \text{NBAP}) + (50\% \times \text{LBAP});$$

Where;

NBAP = “National Base Asphalt Price”, (in dollars/ton) is calculated based on arithmetic average of the previous four weeks “Posted Prices Asphalt Cement” for the “East Coast Market – GA/FL” as listed in the “ASPHALT WEEKLY MONITOR®” published by “Poten and Partners” or at www.poten.com.

LBAP = “Local Base Asphalt Price”, (in dollars/ton) is based on the arithmetic average posted price of PG asphalt cement as specified in Section 820, from the Department’s monthly survey obtained from approved asphalt cement suppliers of bituminous materials to the Department projects F.O.B. the suppliers terminal. However, the highest price and the lowest price are excluded from the calculation of average price, LBAP.

4. **“Asphalt Cement Quantity Calculation”:** The calculation of asphalt cement quantity for each mix type will be based on the asphalt cement content (AC %) of the approved Job Mix Formula (JMF) as specified in Subsection 400.1.03.C. The following calculation formula will be used to determine asphalt cement quantity:

Asphalt Cement Quantity = Hot Mix Asphaltic Concrete monthly total in tons (megagrams) per mix type certified for the payment x AC (%)

The Total Monthly Tonnage (TMT) of asphalt cement computed by the Engineer will be calculated as follows:

Section 400—Hot Mix Asphaltic Concrete Construction

TMT = Sum of all asphalt cement quantities, including polymer modified asphalt binder and non-modified asphalt cement, based on the Hot Mix Asphaltic Concrete of the various mix types per ton (megagram) certified for payment.

Asphalt Cement Price for the Month (APM) will be adjusted monthly. Price adjustments (PA) will be made monthly and all calculations for Price Adjustments shall be performed by the Engineer as specified in SOP-39 “Determination of Asphalt Cement Index and Asphalt Cement Price Adjustment”.

5. **“Other Restrictions”:**

- a. No asphalt cement price adjustment will be made for cut-back, and emulsified asphalt when used for bituminous tack coat.
- b. There is a cap of 125% above the APL for any price adjustment.
- c. Unless specifically provided for by Supplemental Agreement or Contract Amendment, no further asphalt cement price adjustment will be made after *the original Contract Time has expired*. Irrespective of any other provision in the contract, for purposes of this specification, “Contract Time” does not include any time extensions or Supplemental Agreements which affect the completion of the Contract. The Asphalt Cement Price Adjustment for any hot mix asphalt placed after the original Contract Time expires will be computed based on the Monthly Asphalt Cement Price at the time the Contract Time has expired, or the Monthly Asphalt Cement Price at the time the Contract was let, *whichever is less*.

First Use Date 2001 Specification: November 18, 2005

Revised: August 9, 2006

Revised September 27, 2006

Revised: December 7, 2006

(On System) Revised: February 22, 2007

(On System) Revised: November 2, 2007

(On System) Revised: December 4, 2007

Revised: February 4, 2008

**DEPARTMENT OF TRANSPORTATION
STATE OF GEORGIA**

Project Number: CSNHS-0008-00(415)

P.I. Number: 0008415

Fulton County

SPECIAL PROVISION

Section 402—Hot Mix Recycled Asphaltic Concrete

Delete Subsection 402.4 and 402.5 and substitute the following:

402.4 Measurement and Payment

The work performed and the materials furnished as described in this Specification will not be measured separately.

Work and materials will be paid for under CONSTRUCTION COMPLETE. Includes providing materials, hauling and necessary crushing, processing, placing, rolling and finishing the recycled mixture, and providing labor, tools, equipment, and incidentals necessary to complete the work, including hauling and stockpiling RAP or RAS material.

402.5.01 Adjustments

A. Materials Produced and Placed During the Adjustment Period

An adjustment period is allowed at the start of mixing operations for each type of mix placed on the Contract. The adjustment period is provided to adjust or correct the mix and to establish the construction procedures and sequence of operations.

The adjustment period consists of the tons (megagrams) of the affected mix produced and placed on the first day of operation. If this quantity is less than 500 tons (500 Mg), the Engineer may combine the tons (megagrams) produced and placed on the first day of operation with the tons (megagrams) produced and placed on the next production day of the affected mix for the adjustment period.

The material produced and placed during the mixture adjustment period is one lot. If the mix is adjusted during this period, a new lot may be necessary, but a new adjustment period will not be permitted.

This material shall be paid for at 100 percent of the Contract Unit Price provided it meets the minimum requirements for a 1.00 pay factor for asphalt cement content and a 0.90 pay factor for gradation in the [Mixture Acceptance Schedule—Table 9 or 10](#) of [Subsection 400.3.06](#).

If the material placed during the adjustment period fails to meet the above requirements, it will be paid for using the applicable acceptance schedule. However, when mixture used for leveling at a spread rate of 90 lbs/yd² (50 kg/m²) or less is also used for the surface mix at a spread rate greater than 90 lbs/yd² (50 kg/m²), an additional

adjustment period will be allowed for compaction only. This material will be paid for at a 1.00 pay factor provided it:

Meets the minimum requirements for a 1.00 pay factor in the [Mixture Acceptance Schedule—Table 9 or 10](#) of [Subsection 400.3.06](#) for both asphalt content and gradation.

Meets the minimum requirements for a 0.90 pay factor in [Table 12 of Subsection 402.5.01.C, “Calculate Mean Pavement Air Voids.”](#)

Mixture which does not meet these requirements shall be paid for using the applicable acceptance schedule.

B. Determine Lot Acceptance

Pay factor adjustments are based on control sieves and asphalt cement content. The control sieves used in the mixture acceptance schedule for the various types of mix are indicated below:

Control Sieves Used in the Mixture Acceptance Schedule	
Asphaltic concrete 25 mm Superpave	1/2 in., No. 8 (12.5 mm, 2.36 mm) sieves and asphalt cement
Asphaltic concrete 19 mm Superpave	3/8 in., No. 8 (9.5 mm, 2.36 mm) sieves and asphalt cement
Asphaltic concrete 12.5 mm Superpave	3/8 in., No. 8 (9.5 mm, 2.36 mm) sieves and asphalt cement
Asphaltic concrete 9.5 mm Superpave	No. 4, No. 8 (4.75 mm, 2.36 mm) sieves and asphalt cement
Asphaltic concrete 4.75 mm Mix	No. 8 (2.36 mm) sieve and asphalt cement

The Department will perform the following tasks:

- Using the [Mixture Acceptance Schedule—Table 9 or 10](#), of [Subsection 400.3.06](#) to determine the mean of the deviations from the job mix formula per test results per lot.
- Determine this mean by averaging the actual numeric value of the individual deviations from the job mix formula; disregard whether the deviations are positive or negative amounts.
- Use the Asphalt Cement Content and Aggregate Gradation of Asphalt Concrete [Mixture Acceptance Schedule—Table 9](#) of [Subsection 400.3.06](#) to determine acceptance of surface mixes and the [Mixture Acceptance Schedule—Table 10](#) of [Subsection 400.3.06](#) to determine acceptance of subsurface mixes.

On Contracts involving 1,000 tons (1000 Mg) or less of asphaltic concrete, the mixture is accepted for 100 percent payment of the asphaltic concrete Unit Price provided it meets the following:

- Minimum requirements for a 1.00 pay factor for asphalt cement content and a 0.90 pay factor for gradation in the applicable [Mixture Acceptance Schedule—Table 9 or 10](#) of [Subsection 400.3.06](#).
- Minimum requirements for a 0.90 pay factor in [Table 12 of Subsection 402.5.01.C, “Calculate Pavement Mean Air Voids.”](#)

If the material placed on Contracts involving 1,000 tons (1000 Mg) or less of asphaltic concrete does not meet the above requirements, the material will be paid for using the applicable acceptance schedule.

C. Calculate Pavement Mean Air Voids

The Department will determine the percent of maximum air voids for each lot by dividing the pavement mean air voids by the maximum pavement mean air voids acceptable.

The Department will determine the payment for each lot by multiplying the Contract Unit Price by the adjusted pay factor shown in the following Air Voids Acceptance schedule:

Table 12 - Air Voids Acceptance Schedule

Pay Factor	Percent of Maximum Air Voids (Lot Average of Tests)	Percent of Maximum Air Voids (Lot Average all Tests) (for
------------	---	---

		Reevaluations)
1.00	≤100	≤100
0.97	100.1 — 105	100.1 — 104
0.95	105.1 — 112	104.1— 109
0.90	112.1 — 124	109.1 — 118
0.80	124.1 — 149	118.1 — 136
0.70	149.1 —172	136.1 — 153
0.50	172.1 — 191	153.1 — 166

When the range tolerance is exceeded, the Department will apply a pay factor of 0.95 as described in [Subsection 400.3.06.B.2.](#)

D. Asphaltic Concrete For Temporary Detours

Hot mix asphaltic concrete placed on temporary detours that will not remain in place as part of the permanent pavement does not require hydrated lime. Hot mix used for this purpose is paid for at an adjusted Contract Price.

Where the Contract Price of the asphaltic concrete for permanent pavement is let by the ton (megagram), the Contract Price for the asphaltic concrete placed on temporary detours is adjusted by subtracting \$0.75/ton (\$0.85/mg) of mix used.

Where the Contract price of the mix in the permanent pavement is based on the square yard (meter), obtain the adjusted price for the same mix used on the temporary detour by subtracting \$0.04/yd² (\$0.05/ m²) per 1-in (25-mm) plan depth.

Further price adjustments required in [Subsection 400.3.06, “Quality Acceptance.”](#) are based on the appropriate adjusted Contract Price for mix used in the temporary detour work.

E. Determine Lot Payment

Determine the lot payment as follows:

1. When one of the pay factors for a specific acceptance lot is less than 1.0, determine the payment for the lot by multiplying the Contract Unit Price by the adjusted pay factor.
2. When two or more pay factors for a specific acceptance lot are less than 1.0, determine the adjusted payment by multiplying the Contract Unit Price by the lowest pay factor.

If the mean of the deviations from the job mix formula of the tests for a sieve or asphalt cement content exceeds the tolerances established in the [Mixture Acceptance Schedule—Table 9 or 10 of Subsection 400.3.06](#) and if the Engineer determines that the material need not be removed and replaced, the lot may be accepted at an adjusted unit price as determined by the Engineer. If the pavement mean air voids exceed the tolerances established in the [Air Voids Acceptance Schedule – Table 12 Subsection 402.5.01.C](#), remove and replace the materials at the Contractor’s expense.

If the Engineer determines that the material is not acceptable to leave in place, remove and replace the materials at the Contractor’s expense.

F. Asphalt Cement Price Adjustment

1. **Formula:** The Asphalt Cement Price Adjustment will be computed on a *monthly* basis in accordance with the following:

PA = Price Adjustment.

APM= the “Monthly Asphalt Cement Price” for the month the hot mix asphalt is placed.

APL = the “Monthly Asphalt Cement Price” for the month which the project was let.

TMT = Total Monthly Tonnage of asphalt cement computed by the Engineer based on the Hot Mix Asphaltic Concrete of the various types per ton (megagram) certified for payment.

- a. If the asphalt cement price for the month is *greater* than the asphalt cement price for the month in which the project was let:

$$PA = [((APM-APL)/APL) - 0.05] \times TMT \times APL$$

- b. If the asphalt cement price for the month is *less* than the asphalt cement price for the month in which the project was let:

$$PA = [((APM-APL)/APL) + 0.05] \times TMT \times APL$$

2. **Price Adjustment Triggers:** No price adjustment shall be made on any hot mix asphalt placed on projects with less than 366 calendar days from the Contract Letting Date to the specified completion date. If the Original Contract contains 366 calendar days or more the Price Adjustment Trigger shall be made for any hot mix asphalt placed from the Contract Letting Date to the specified completion date. A price adjustment shall not be made until the APM is greater than 5% above or below the APL.
3. **“Monthly Asphalt Cement Price”:** The Department will determine and publish a “Monthly Asphalt Cement Price” based on the following formulas:

$$\text{Monthly Asphalt Cement Price} = (50\% \times \text{NBAP}) + (50\% \times \text{LBAP});$$

Where;

NBAP = “National Base Asphalt Price”, (in dollars/ton) is calculated based on arithmetic average of the previous four weeks “Posted Prices Asphalt Cement” for the “East Coast Market – GA/FL” as listed in the “ASPHALT WEEKLY MONITOR®” published by “Poten and Partners” or at www.poten.com.

LBAP = “Local Base Asphalt Price”, (in dollars/ton) is based on the arithmetic average posted price of PG asphalt cement as specified in Section 820, from the Department’s monthly survey obtained from approved asphalt cement suppliers of bituminous materials to the Department projects F.O.B. the suppliers terminal. However, the highest price and the lowest price are excluded from the calculation of average price, LBAP.

4. **“Asphalt Cement Quantity Calculation”:** The calculation of asphalt cement quantity for each mix type will be based on the asphalt cement content (AC %) of the approved Job Mix Formula (JMF) as specified in Subsection 400.1.03.C. The following calculation formula will be used to determine asphalt cement quantity:

$$\text{Asphalt Cement Quantity} = \text{Hot Mix Asphaltic Concrete monthly total in tons (megagrams) per mix type certified for the payment} \times \text{AC} (\%)$$

The Total Monthly Tonnage (TMT) of asphalt cement computed by the Engineer will be calculated as follows:

TMT = Sum of all asphalt cement quantities, including polymer modified asphalt binder and non-modified asphalt cement, based on the Hot Mix Asphaltic Concrete of the various mix types per ton (megagram) certified for payment.

Asphalt Cement Price for the Month (APM) will be adjusted monthly. Price adjustments (PA) will be made monthly and all calculations for Price Adjustments shall be performed by the Engineer as specified in SOP-39 “Determination of Asphalt Cement Index and Asphalt Cement Price Adjustment”.

5. **“Other Restrictions”:**
- a. No asphalt cement price adjustment will be made for cut-back, and emulsified asphalt when used for bituminous tack coat.

- b. There is a cap of 125% above the APL for any price adjustment.
- c. Unless specifically provided for by Supplemental Agreement or Contract Amendment, no further asphalt cement price adjustment will be made after ***the original Contract Time has expired.*** Irrespective of any other provision in the contract, for purposes of this specification, "Contract Time" does not include any time extensions or Supplemental Agreements which affect the completion of the Contract. The Asphalt Cement Price Adjustment for any hot mix asphalt placed after the original Contract Time expires will be computed based on the Monthly Asphalt Cement Price at the time the Contract Time has expired, or the Monthly Asphalt Cement Price at the time the Contract was let, *whichever is less.*

Revised November 21, 2006

Revised February 22, 2007

Revised: December 4, 2007

Revised: February 4, 2008

Georgia Department of Transportation
State of Georgia

Project Number: CSNHS-0008-00(415)
P.I. Number: 0008415
Fulton County

Special Provision

Section 413—Bituminous Tack Coat

413.1 General Description

This work includes furnishing and applying a bituminous tack coat on a prepared road surface including cleaning the road surface.

413.1.01 Definitions

General Provisions 101 through 150.

413.1.02 Related References

A. Standard Specifications

[Section 109—Measurement and Payment](#)

[Section 400—Hot Mix Asphaltic Concrete Construction](#)

[Section 424—Bituminous Surface Treatment](#)

[Section 427—Emulsified Asphalt Slurry Seal](#)

[Section 820—Asphalt Cement](#)

[Section 824—Cationic Asphalt Emulsion](#)

B. Referenced Documents

General Provisions 101 through 150.

413.1.03 Submittals

General Provisions 101 through 150.

413.2 Materials

Ensure that materials meet the following Specifications:

Material	Section
Asphalt cement, performance grade PG 58-22, PG 64-22, or PG 67-22	820.2.01

Cationic emulsified asphalt CRS-2h or CRS-3	824.2.01
---	--------------------------

Asphalt cement of performance grade PG 58-22, PG 64-22 or PG 67-22 is used for bituminous tack coat in work performed in [Section 400](#). Use cationic emulsified asphalt as a special application material only if directed by the Engineer.

The Department may change the grade or type of bituminous materials without a change in the Contract Unit Price if the Engineer determines that the grade or type selected is not performing satisfactorily.

413.2.01 Delivery, Storage, and Handling

General Provisions 101 through 150.

413.3 Construction Requirements

413.3.01 Personnel

General Provisions 101 through 150.

413.3.02 Equipment

Provide equipment in good repair, including the following units that meet the requirements of [Subsection 424.3.02, Equipment.](#)

- Power broom and blower
- Pressure distributor

413.3.03 Preparation

General Provisions 101 through 150.

413.3.04 Fabrication

General Provisions 101 through 150.

413.3.05 Construction

A. Seasonal and Weather Limitation

Do not apply tack coat if the existing surface is wet or frozen. Do not place emulsified asphalt if the air temperature in the shade is less than 40 °F (4 °C).

B. Application

Coat the entire areas to be paved with the tack coat unless directed otherwise by the Engineer. Apply tack coat with distributor spray bars instead of hand hoses, except in small areas that are inaccessible to spray bars.

C. Temperature of Material

Apply bituminous materials within the temperature ranges specified below.

Bituminous Materials	Temperature of Application °F (°C)
Asphalt cement	350 - 400 (175 - 205)
CRS-2h	140 - 180 (60 - 80)
CRS-3	140 - 180 (60 - 80)

D. Cleaning

Immediately before applying the tack coat, clean the entire area free of loose dirt, clay, and other foreign materials.

E. Application Rate

The Engineer will determine the application rate of the bituminous tack coat.

F. Limitations and Areas Coated

Apply only enough tack coat to the prepared road surface that can be covered with the new pavement course the same working day the tack coat is applied.

G. Maintenance and Protection

After applying the tack coat material, allow it to break until it is tacky enough to receive the surface course. Do not allow traffic on the tack.

413.3.06 Quality Acceptance

General Provisions 101 through 150.

413.3.07 Contractor Warranty and Maintenance

General Provisions 101 through 150.

413.4 Measurement

Bituminous materials for tack coat applied and accepted are measured as outlined in [Subsection 109.02, "Measurement of Bituminous Materials."](#)

Diluting emulsified tack coat is not ordinarily allowed except when used underneath slurry seal. The composition of diluted emulsified tack coat defined in [Subsection 427.3.05, "Construction"](#) is measured by the gallon (liter) of diluted mix.

413.4.01 Limits

General Provisions 101 through 150.

413.5 Payment

The accepted volume of bituminous material will be paid for under CONSTRUCTION COMPLETE for bituminous tack coat of the type and grade approved by the Engineer, complete in place. Includes preparing, cleaning, furnishing, hauling, applying material, and providing incidentals to complete the work.

413.5.01 Adjustments

A. Asphalt Cement Price Adjustment

1. **Formula:** The Asphalt Cement Price Adjustment will be computed on a *monthly* basis in accordance with the following:

PA = Price Adjustment.

APM= the "Monthly Asphalt Cement Price" for the month the bituminous tack coat is placed.

APL = the "Monthly Asphalt Cement Price" for the month which the project was let.

TMT = Total Monthly Tonnage of asphalt cement used for bituminous tack coat (asphalt cement tack coat only, emulsified bituminous materials for tack coat are excluded) converted from gallons to tons (megagrams) by the Engineer and certified for payment.

- a. If the asphalt cement price for the month is *greater* than the asphalt cement price for the month in which the project was let:

$$PA = [((APM-APL)/APL) - 0.05] \times TMT \times APL$$

- b. If the asphalt cement price for the month is *less* than the asphalt cement price for the month in which the project was let:

$$PA = [((APM-APL)/APL) + 0.05] \times TMT \times APL$$

2. **Price Adjustment Triggers:** No price adjustment shall be made on any bituminous tack coat placed on projects with less than 366 calendar days from the Contract Letting Date to the specified completion date. If the Original Contract contains 366 calendar days or more the Price Adjustment

Trigger shall be made for any bituminous tack coat placed from the Contract Letting Date to the specified completion date. A price adjustment shall not be made until the APM is greater than 5% above or below the APL.

3. **“Monthly Asphalt Cement Price”**: The Department will determine and publish a “Monthly Asphalt Cement Price” based on the following formulas:

Monthly Asphalt Cement Price = (50% x NBAP) + (50% x LBAP);

Where;

NBAP = “National Base Asphalt Price”, (in dollars/ton) is calculated based on arithmetic average of the previous four weeks “Posted Prices Asphalt Cement” for the “East Coast Market – GA/FL” as listed in the “ASPHALT WEEKLY MONITOR®” published by “Poten and Partners” or at www.poten.com.

LBAP = “Local Base Asphalt Price”, (in dollars/ton) is based on the arithmetic average posted price of PG asphalt cement as specified in Section 820, from the Department’s monthly survey obtained from approved asphalt cement suppliers of bituminous materials to the Department projects F.O.B. the suppliers terminal. However, the highest price and the lowest price are excluded from the calculation of average price, LBAP.

4. **“Asphalt Cement Quantity Calculation”**: The Total Monthly Tonnage (TMT) of asphalt cement computed by the Engineer will be calculated as follows:

TMT = Sum of all asphalt cement quantities used as bituminous tack coat converted from gallons to tons (megagrams) certified for payment.

Asphalt Cement Price for the Month (APM) will be adjusted monthly. Price adjustments (PA) will be made monthly and all calculations for Price Adjustments shall be performed by the Engineer as specified in SOP-39 “Determination of Asphalt Cement Index and Asphalt Cement Price Adjustment”.

5. **“Other Restrictions”**:
 - a. There is a cap of 125% above the APL for any price adjustment.
 - b. Unless specifically provided for by Supplemental Agreement or Contract Amendment, no further asphalt cement price adjustment will be made after *the original Contract Time has expired*. Irrespective of any other provision in the contract, for purposes of this specification, “Contract Time” does not include any time extensions or Supplemental Agreements which affect the completion of the Contract. The Asphalt Cement Price Adjustment for asphalt cement used as bituminous tack coat placed after the original Contract Time expires will be computed based on the Monthly Asphalt Cement Price at the time the Contract Time has expired, or the Monthly Asphalt Cement Price at the time the Contract was let, *whichever is less*.

DEPARTMENT OF TRANSPORTATION

STATE OF GEORGIA

SPECIAL PROVISION

Project Number: CSNHS-0008-00(415)

P.I. Number: 0008415

Fulton County

Section 424—Bituminous Surface Treatment

Delete Section 424 and substitute the following:

424.1 General Description

This work includes placing one or more applications of bituminous material and aggregate on a previously prepared base or pavement.

424.1.01 Definitions

- **Single Surface Treatment:** One application of bituminous material that is covered with aggregate.
- **Double Surface Treatment:** A bituminous material application that is covered with aggregate of the size specified in the proposal followed by a second bituminous material application that is covered with a second specified size aggregate.
- **Triple Surface Treatment:** A bituminous material application that is covered with a specified size aggregate followed by subsequent applications of bituminous material that are covered with successively smaller size nominal aggregates.

424.1.02 Related References

A. Standard Specifications

[Section 105—Control of Work](#)

[Section 800—Coarse Aggregate](#)

[Section 820—Asphalt Cement](#)

[Section 824—Cationic Asphalt Emulsion](#)

B. Referenced Documents

[QPL 65](#)

424.1.03 Submittals

General Provisions 101 through 150.

424.2 Materials

A. Bituminous Material

Select the bituminous material from any type and grade listed in the materials table below. Notify the Engineer at least 10 days before ordering the bituminous material. The Engineer must approve the bituminous material choice.

For a list of latex sources, see [QPL 65](#).

Ensure that materials meet the requirements of the following Specifications:

Material	Section
Asphalt Cement, Performance Grade PG 58-22 or PG 64-22*	820.2.01
Cationic Asphalt Emulsion, Grade CRS-2h or CRS-3*	824.2.01
Coarse Aggregate, Class A Crushed Stone or Crushed Slag, Group I or II	800.2.01
* Use PG 64-22 or CRS-3 only at the Engineer's direction. (See Subsection 424.3.05.B .)	

B. Aggregates

The size and group of aggregates used in the surface treatment are specified in the Proposal under the appropriate Line Item.

Do not use unconsolidated limerock unless provided for in the Plans or Proposal.

Use Class B aggregates only where the surface treatment is used for shoulder construction or where it is to be overlaid with asphaltic concrete.

424.2.01 Delivery, Storage, and Handling

General Provisions 101 through 150.

424.3 Construction Requirements

424.3.01 Personnel

General Provisions 101 through 150.

424.3.02 Equipment

Have the Engineer approve equipment types and quantities before using equipment on the Project.

Ensure that the equipment used to construct the surface treatment:

- Produces work that complies with the standards in this section
- Is on the Project and in proper working order before construction begins and during construction.

A. Aggregate Spreader

The Department will inspect annually the aggregate spreader before it is used in the work. If the spreader is approved, the Department will attach an equipment certification sticker to the spreader.

Use a self-propelled aggregate spreader that can apply aggregate at the desired rate uniformly and accurately without corrugation, overlaps, or excess deficient areas.

Ensure that the spreader can spread courses to the required widths. Provide spreaders to promptly cover the full width of the asphalt application.

B. Pressure Distributor

The Department will inspect annually the pressure distributor before it is used in the work. If the distributor is approved, the Department will attach an equipment certification sticker to the distributor. The pressure distributor should be equipped as follows:

1. Mount the pressure distributor on pneumatic tires wide enough to prevent damage to the road surface.
2. Design, equip, maintain, and operate the distributor so that the bituminous material will be heated and applied evenly throughout the length of the spray bars. Ensure that it maintains a constant, uniform pressure on the nozzles.
3. Install screens between the tank and the nozzles and clean them frequently to prevent clogging.
4. Use an adjustable distributor that can deliver controlled amounts of bituminous material from 0.04 to 1.0 gal/yd², ± 0.02 gal/yd² (0.18 to 4.53 L/m², ± 0.10 L/m²) up to 24 ft (7.2 m) wide without atomization, streaking, or pulsation in the flow.
5. Use a distributor equipped with the following:
 - A tachometer and thermometers to indicate the application rate and the temperature of the tank contents

- Measuring devices to accurately indicate the amount of bituminous material, in gallons (liters), in the distributor before and after each application
- Full circulating spray bars that can be adjusted laterally to conform to a stringline and capable of vertical and horizontal adjustment.
- A positive shut-off control to prevent dripping bituminous material on the roadway
- A distributor tank equipped with a sample valve in a safe and convenient location to obtain bituminous material samples

C. Heating Equipment

Ensure that heating equipment will heat and maintain the bituminous material uniformly at the temperature required. Provide an accurate thermometer.

D. Steel-Wheeled Rollers

Use self-propelled, tandem-type steel-wheeled rollers. The rollers shall weigh from 3 to 8 tons (3 to 7 Mg). Ensure that the roller weights within these limits can properly seat the aggregate without fracturing the aggregate particles. Equip the roller drums with scrapers to prevent pick up of material. Combination rollers with pneumatic-tired wheels that can be alternated with a steel drum are permitted as a substitute for steel-wheeled rollers.

E. Pneumatic-Tired Rollers

Use self-propelled, two axles, pneumatic-tired rollers with smooth-tread rubber tires aligned such that gaps between the tires on one axle are covered by the tires of the other axle. Equip the roller tires with scrapers and scrubbers to prevent pick up of material. Ensure that all tires are of the same size and ply rating and inflated to a minimum of 60 psi (415 kPa). Maintain tire pressure such that the difference in pressure between any two tires does not exceed 5 psi (35 kPa). Provide ballast as directed by the Engineer.

F. Power Broom and Power Blower

Provide at least one power broom and one power blower, or a combination power broom and blower, that can remove dust or loose materials from the road surface.

424.3.03 Preparation

Firmly compact, finish, and prime new bases. Ensure that the bases conform to the lines, grades, and cross sections within the tolerances specified.

A. Removing Foreign Material

Use power brooms, power blowers, hand brooms, or other means to remove loose material, dust, dirt, clay, and other materials that prevent bituminous materials from adhering to the base.

Take special care to clean the outer edges thoroughly. Where necessary, use a motor grader blade to remove excess material off the paving edge.

B. Condition of Prime

Check the condition of prime as follows:

1. Ensure the prime is cured before placing the mat course.
2. Repair the prime if it is loose, soft, unbonded, removed, or damaged.
3. Remove concentrations of excess prime.
4. Perform additional rolling with a pneumatic-tired roller before surface treatment when directed by the Engineer.

424.3.04 Fabrication

General Provisions 101 through 150.

424.3.05 Construction

A. Observing Seasonal and Weather Limitations

Apply bituminous surface treatment and corresponding bituminous materials only between the dates given in [Table 1](#), below. The dates are given by zones shown on the [Georgia Geographic Map](#), below

No exceptions are permitted except as authorized by the Engineer.

Table 1—Surface Treatment Seasonal Restrictions

Zone	Asphalt Cement	Emulsified Asphalt
1	May 1–September 15	April 10–September 15
2	April 15–October 5	April 1–October 5
3	April 10–October 20	March 25–October 20
4	April 1–November 1	March 15–November 1

Do not apply asphalt cement to a wet surface or when the temperature is below 65 °F (18 °C). Never apply emulsions if the temperature is below 55 °F (13 °C).

NOTE: If hot mix asphaltic concrete will be applied over the surface treatment, the Engineer may waive the seasonal and temperature limitations providing that traffic is not permitted on the surface treatment until it is covered with hot mix asphaltic concrete.

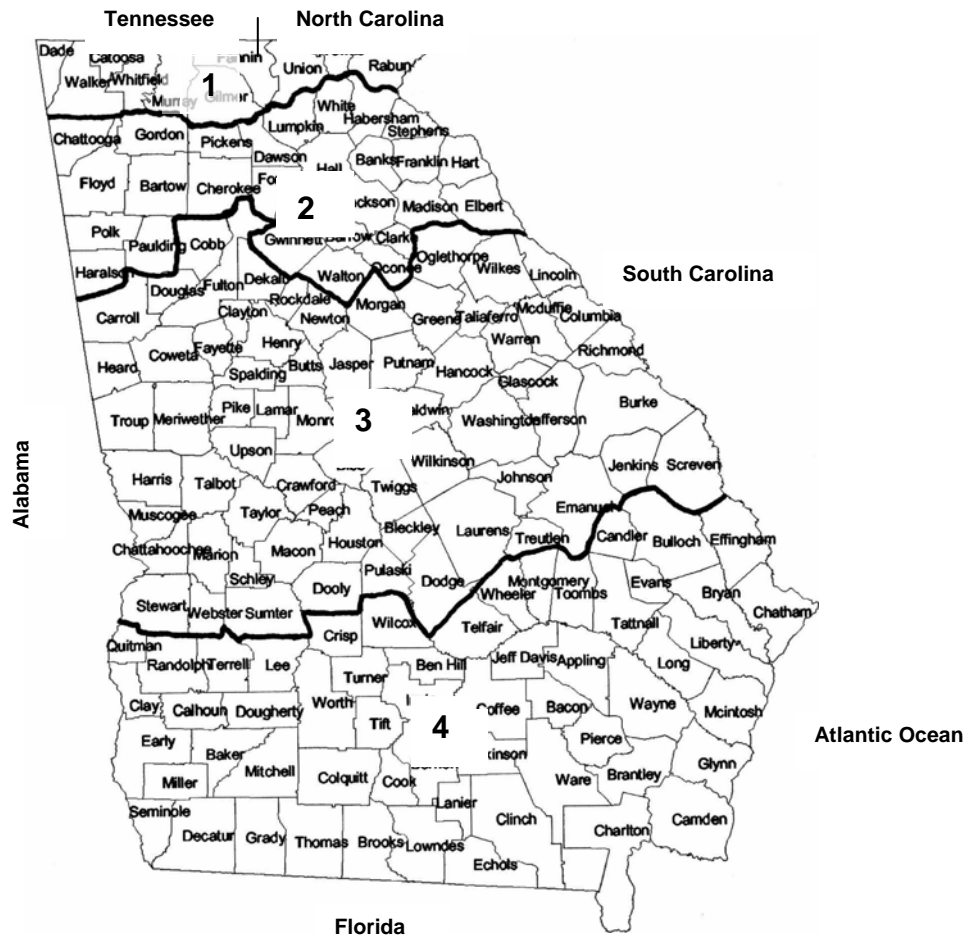

Georgia Department of Transportation Geographical Map
For Surface Treatment and Slurry Seal

B. Using PG 64-22 or CRS-3

Only use PG 64-22 or CRS-3 when directed by the Engineer due to a problem with excessive aggregate pickup during high ambient temperature.

C. Observing Sequence of Operations and Quantities of Materials

The sequence of operations and quantities of materials are shown in [Table 2 \(Table 2—metric\)](#).

The Engineer will determine the material quantities to be used during construction and may change the minimum or maximum application rate of any course during construction if the total quantities are within the amounts shown in [Table 2 \(Table 2—metric\)](#). Any deviation, or minus from the table quantities, will require a negotiated adjustment of the Contract price, which will be authorized by an approved Supplemental Agreement.

When a single application of bituminous surface treatment is used as a Crack-Relief Interlayer, use the quantities of materials shown in [Table 2a \(Table 2a Metric\)](#).

Section 424—Bituminous Surface Treatment – Table 2

Application		Type Construction									
		Single			Double			Triple			
Stone Sizes	1st appl.		#89	#7	#6		#7	#6		#6	#5
	2nd appl.						#89	#7		#7	#7
	3rd appl.									#89	#89
		Control Tolerance				Control Tolerance			Control Tolerance		
1st Application Bituminous Materials (gal/yd ²) PG58-22 or PG64-22		± .02	.17–.19	.18–.25	.22–.30	± .02	.20–.27	.26–.34	± .02	.20–.30	.24–.34
CRS-2h, CRS-3		± .02	.20–.22	.21–.29	.25–.35	± .02	.23–.32	.30–.40	± .02	.23–.35	.28–.40
1st Application Stone (ft ³ /yd ²)		± .03	.14–.18	.18–.26	.30–.42	± .03	.18–.26	.30–.42	± .03	.30–.42	.41–.53
2nd Application Bituminous Materials (gal/yd ²) PG58-22 or PG64-22						± .02	.18–.24	.24–.31	± .02	.20–.27	.20–.27
CRS-2h, CRS-3						± .02	.21–.28	.28–.36	± .02	.23–.32	.23–.32
2nd Application Stone (ft ³ /yd ²)						± .03	.14–.18	.18–.26	± .03	.18–.26	.18–.26
3rd Application Bituminous Materials (gal/yd ²) PG58-22 or PG64-22									± .02	.18–.24	.18–.24
CRS-2h, CRS-3									± .02	.21–.28	.21–.28
3rd Application Stone (ft ³ /yd ²)									± .03	.14–.18	.14–.18
Total Bituminous Materials (gal/yd ²) PG58-22 or PG64-22		± .02	.17–.19	.18–.25	.22–.30	± .03	.38–.51	.50–.65	± .04	.58–.81	.62–.85
CRS-2h, CRS-3		± .02	.20–.22	.21–.29	.25–.35	± .03	.44–.60	.58–.76	± .04	.67–.95	.72–1.0
Total Stone (ft ³ /yd ²)		± .03	.14–.18	.18–.26	.30–.42	± .04	.32–.44	.48–.68	± .05	.62–.86	.73–.97
Notes:											
<ul style="list-style-type: none"> The bituminous material and stone for each application may be varied by the Engineer, at no increase in cost, outside of the minimum or maximum shown in the table provided the total of the materials is within the limits of the total minimum and total maximum of all courses. Maintain the control tolerances shown above or stop the work until the necessary corrections are made. Apply at least one seal coat to the mat course on the same day when multiple applications are specified. 											

Section 424—Bituminous Surface Treatment, Crack-Relief Interlayer – Table 2a

Bituminous Material Application (gal/yd ²)	Application Rate	Control Tolerance
PG 58-22 or PG 64-22	.20 – .25	± .02
CRS-2h or CRS 3	.25 – .29	± .02

Aggregate Application (ft ³ /yd ²)	Application Rate	Control Tolerance
#7	.22 – .26	± .01

Notes:

- Target application rates for bituminous material and cover aggregate will be established by the Engineer within the limits shown in Table 2a.
- Maintain the control tolerances shown above or stop the work until the necessary corrections are made.
- Cover the single surface treatment Crack-Relief Interlayer with HMA Leveling on the same day.

Section 424—Bituminous Surface Treatment – Table 2 (Metric)

Application		Type Construction									
		Single			Double			Triple			
Stone Sizes	1st appl.		#89	#7	#6		#7	#6		#6	#5
	2nd appl.						#89	#7		#7	#7
	3rd appl.									#89	#89
	Control Tolerance					Control Tolerance			Control Tolerance		
1st Application Bituminous Materials (L/m ²) PG58-22 or PG64-22		± .09	.77–.86	.82–1.13	1.00–1.36	± .09	.91–1.22	1.18–1.54	± .09	.91–1.36	1.09–1.54
CRS-2h, CRS-3		± .09	.91–1.00	.95–1.31	1.13–1.58	± .09	1.04–1.45	1.36–1.81	± .09	1.04–1.58	1.27–1.81
1st Application Stone (m ³ /m ²)		± .001	.005–.006	.006–.009	.01–.014	± .001	.006–.009	.01–.015	± .001	.01–.014	.014–.018
2nd Application Bituminous Materials (L/m ²) PG58-22 or PG64-22						± .09	.82–1.09	1.09–1.40	± .09	.91–1.22	.91–1.22
CRS-2h, CRS-3						± .09	.95–1.26	1.27–1.63	± .09	1.04–1.45	1.04–1.45
2nd Application Stone (m ³ /m ²)						± .001	.005–.006	.006–.009	± .001	.006–.009	.006–.009
3rd Application Bituminous Materials (L/m ²) PG58-22 or PG64-22									± .09	.82–1.09	.82–1.09
CRS-2h, CRS-3									± .09	.95–1.27	.95–1.27
3rd Application Stone (m ³ /m ²)									± .001	.005–.006	.005–.006
Total Bituminous Materials (L/m ²) PG58-22 or PG64-22		± .09	.77–.86	.82–1.13	1.00–1.36	± .14	1.72–2.31	2.26–2.94	± .18	2.63–3.67	2.81–4.53
CRS-2h, CRS-3		± .09	.91–1.00	.95–1.31	1.13–1.58	± .14	1.99–2.72	2.63–3.44	± .18	3.04–4.30	3.26–4.53
Total Stone (m ³ /m ²)		± .001	.005–.006	.006–.009	.01–.014	± .0013	.011–.015	.016–.024	± .0016	.021–.029	.025–.033

Notes:

- The bituminous material and stone for each application may be varied by the Engineer, at no increase in cost, outside of the minimum or maximum shown in the table provided the total of the materials is within the limits of the total minimum and total maximum of all courses.
- Maintain the control tolerances shown above or stop the work until the necessary corrections are made.
- Apply at least one seal coat to the mat course on the same day when multiple applications are specified.

Section 424—Bituminous Surface Treatment, Crack-Relief Interlayer – Table 2a (Metric)

Bituminous Material Application (L/m ²)	Application Rate	Control Tolerance
PG 58-22 or PG 64-22	.91 – 1.13	± .09

CRS-2h or CRS 3	1.13 – 1.31	± .09
Aggregate Application (m³/m²)	Application Rate	Control Tolerance
#7	.007 – .009	± .0003
Notes: <ul style="list-style-type: none"> Target application rates for bituminous material and cover aggregate will be established by the Engineer within the limits shown in Table 2a (Metric). Maintain the control tolerances shown above or stop the work until the necessary corrections are made. Cover the single surface treatment Crack-Relief Interlayer with HMA Leveling on the same day. 		

D. Heating Bituminous Material

Evenly heat the entire mass of bituminous material for each application under positive control. While the material is being applied, maintain it within the specified temperature range.

E. Applying Bituminous Material

The following are temperatures at which bituminous material shall be applied.

Bituminous Material	Asphalt Cement	CRS-2h	CRS-3
Application temperature °F (°C)	275–350 (135– 175)	140– 180 (60– 80)	140– 180 (60– 80)

NOTE 1: Do not store emulsified asphalts at temperatures exceeding 150 °F (65 °C) for any extended time.

NOTE 2: Do not place bituminous surface treatment on fresh asphaltic concrete, except for paved shoulders, until the asphaltic concrete has been in place at least 30 days.

The Engineer will designate the maximum area to which bituminous material may be applied at one time. Apply the material as follows:

- After applying the bituminous material to the section, immediately cover it with the correct application rate of aggregate before beginning the next section.

Do not apply the bituminous material to the full width of the pavement unless the aggregate spreader can immediately cover the full width of the applied material.

NOTE: Never allow bituminous material to chill, set up, dry, or reach a condition that impairs the retention of cover aggregate before the aggregate is applied.

- When a longitudinal joint is necessary:
 - Do not overlap the applications more than 4 in (100 mm).
 - Do not leave any area uncovered.
 - Never allow excess quantities of bituminous materials to build up.
- On curves that require widening:
 - Shoot the extra width on the outside first.
 - Shoot the normal width with the distributor and follow the inside paving edge.
- Ensure that the spray of bituminous material is uniform at all times. If the spray is not uniform:
 - Stop the work.
 - Change equipment, personnel, or methods to attain the required uniformity.
 - Apply bituminous material at one-half the width of the roadway, if necessary.
- If streaking develops:
 - Stop the distributor and correct the problem before proceeding.
 - Use a hand hose or a hand pouring pot to cover the streaked areas at approximately the same application rate of bituminous material.
- If a part of the work cannot be reached by the distributor, treat it by hand hoses with nozzles.

7. Protect curbs, gutters, handrails, and other structures from discoloration by the bituminous material. Remove bituminous material that is sprayed or spilled on these structures.
8. Ensure that the bituminous material joins neatly in place by beginning and ending the asphalt application from a heavy paper or tight trough that is longer than the width of the treatment being applied. Place it to catch and hold the surplus material.
9. When cleaning and emptying the distributor, empty it where the bituminous material can be covered with dirt and completely disposed of without damaging the Rights-of-Way.

F. Spreading Aggregates

Spread the aggregates as follows:

1. Ensure that aggregates do not contain free moisture when spread.
2. Apply aggregate immediately after applying bituminous materials.
3. Uniformly spread the aggregate at the specified rate without corrugations, overlaps, excess, or deficient areas.
4. Move the spreader at a uniform speed, regardless of the grade.
5. Ensure that the distance that the aggregate free falls remains constant during spreading.
6. Remove corrugations. Operate the spreader to prevent overlap of aggregates. If overlap occurs, remove the excess aggregate before rolling.
7. Ensure a uniform aggregate spread by hand spotting and brooming as necessary.

G. Rolling

Observe the following guidelines for rolling bituminous surface treatment:

1. Synchronize the speed of the distributor and aggregate spreader with that of the rolling operation.
2. Use a minimum of two (2) individual rollers, one of which must be a pneumatic-tired roller meeting the requirements of Subsection 424.3.02.E.
3. If a steel-wheeled roller will fracture the aggregate, use pneumatic-tired rollers only.
4. Begin rolling within one minute after spreading the aggregate.
5. Operate rollers at speeds not exceeding 5 mph.
6. Proceed in a longitudinal direction, beginning at the outside edge of the aggregate application.
7. A roller pass is defined as one trip in a single direction.
8. Overlap each roller pass by approximately 1/2 the roller width.
9. Provide a minimum of three (3) roller passes for each layer of aggregate to properly embed the aggregate particles.

<p>Note: Unless a sufficient number of rollers are in operation to complete the above requirements, do not make subsequent applications of bituminous material until rolling of the previous application is completed.</p>

H. Brooming

Use a revolving broom as necessary, supplemented by hand brooming, to remove or redistribute excess stone. Sweep the completed surface treatment within the first three hours of the next available workday following placement. Take care not to unseat bonded stone when sweeping.

I. Controlling Traffic

Do not allow traffic on the surface treatment until the bituminous material has cured sufficiently to ensure that the aggregate will not be loosened, dislodged, or whipped off by slow moving traffic.

Control traffic to speeds not exceeding 25 mph for a minimum of two hours after application of the seal stone and until the Engineer permits the road to be opened to normal traffic speeds.

Use pilot vehicles to control traffic speeds.

424.3.06 Quality Acceptance

General Provisions 101 through 150.

424.3.07 Contractor Warranty and Maintenance

Maintain and protect the surface course as specified in [Section 105](#) until the Project has been accepted. Make repairs as the Engineer directs. The cost of maintenance, protection, and repair is included in the Unit Prices Bid for the Item for which they apply.

424.4 Measurement

No separate measurement will be included for this item.

424.5 Payment

Payment will be made for the accepted area of surface treatment under CONSTRUCTION COMPLETE.

424.5.01 Adjustments

A. Asphalt Cement Price Adjustment

1. **Formula:** The Asphalt Cement Price Adjustment will be computed on a *monthly* basis in accordance with the following:

PA = Price Adjustment.

APM= the “Monthly Asphalt Cement Price” for the month the bituminous surface treatment is placed.

APL = the “Monthly Asphalt Cement Price” for the month which the project was let.

TMT = Total Monthly Tonnage of asphalt cement used for bituminous surface treatment (total gallons of asphalt emulsion used, as measured from distributors, will be multiplied by a factor of 0.65 to determine the quantity in gallons of asphalt cement used) converted from gallons to tons (megagrams) by the Engineer and certified for payment.

- a. If the asphalt cement price for the month is *greater* than the asphalt cement price for the month in which the project was let:

$$PA = [((APM-APL)/APL) - 0.05] \times TMT \times APL$$

- b. If the asphalt cement price for the month is *less* than the asphalt cement price for the month in which the project was let:

$$PA = [((APM-APL)/APL) + 0.05] \times TMT \times APL$$

2. **Price Adjustment Triggers:** No price adjustment shall be made on any bituminous surface treatment placed on projects with less than 366 calendar days from the Contract Letting Date to the specified Completion Date. If the Original Contract contains 366 calendar days or more the Price Adjustment Trigger shall be made for any bituminous surface treatment placed from the Contract Letting Date to the specified Completion Date. A price adjustment shall not be made until the APM is greater than 5% above or below the APL.
3. **“Monthly Asphalt Cement Price”:** The Department will determine and publish a “Monthly Asphalt Cement Price” based on the following formulas:

$$\text{Monthly Asphalt Cement Price} = (50\% \times \text{NBAP}) + (50\% \times \text{LBAP});$$

Where;

NBAP = “National Base Asphalt Price”, (in dollars/ton) is calculated based on arithmetic average of the previous four weeks “Posted Prices Asphalt Cement” for the “East Coast Market – GA/FL” as listed in the “ASPHALT WEEKLY MONITOR®” published by “Poten and Partners” or at www.poten.com.

LBAP = “Local Base Asphalt Price”, (in dollars/ton) is based on the arithmetic average posted price of PG asphalt cement as specified in Section 820, from the Department’s monthly survey obtained from approved asphalt cement suppliers of bituminous materials to the Department projects F.O.B. the suppliers terminal. However, the highest price and the lowest price are excluded from the calculation of average price, LBAP.

4. **“Asphalt Cement Quantity Calculation”**: The Total Monthly Tonnage (TMT) of asphalt cement computed by the Engineer will be calculated as follows:

TMT = Sum of all asphalt cement quantities used for bituminous surface treatment (total gallons of asphalt emulsion used, as measured from distributors, will be multiplied by a factor of 0.65 to determine the quantity in gallons of asphalt cement used) converted from gallons to tons (megagrams) by the Engineer and certified for payment.

Asphalt Cement Price for the Month (APM) will be adjusted monthly. Price adjustments (PA) will be made monthly and all calculations for Price Adjustments shall be performed by the Engineer as specified in SOP-39 “Determination of Asphalt Cement Index and Asphalt Cement Price Adjustment”.

5. **“Other Restrictions”**:

a. There is a cap of 125% above the APL for any price adjustment.

b. Unless specifically provided for by Supplemental Agreement or Contract Amendment, no further asphalt cement price adjustment will be made after *the original Contract Time has expired*. Irrespective of any other provision in the contract, for purposes of this specification, “Contract Time” does not include any time extensions or Supplemental Agreements which affect the completion of the Contract. The Asphalt Cement Price Adjustment for asphalt cement used in bituminous surface treatment placed after the original Contract Time expires will be computed based on the Monthly Asphalt Cement Price at the time the Contract Time has expired, or the Monthly Asphalt Cement Price at the time the Contract was let, *whichever is less*.

Office of Materials and Research

GEORGIA DEPARTMENT OF TRANSPORTATION

STATE OF GEORGIA

SPECIAL PROVISION

Project Number: CSNHS-0008-00(415)

P.I. Number: 0008415

Fulton County

Section 439—Portland Cement Concrete Pavement (Special)

Add the following to Subsection 439.1.02.A:

[Section 511—Reinforcement Steel](#)

Add the following to Subsection 439.1.02.B:

SOP 10

Add the following to Subsection 439.1.03:

D. Paving Plan

Submit a paving plan for approval before beginning construction operations. Include details of all operations in the concrete paving process, including transverse and longitudinal construction joint layout, sequencing, curing, lighting, early opening, leave-outs, sawing, construction methods and description of all equipment. Transmit the paving plan to the Engineer for approval, 30 days prior to concrete placement.

Delete Subsection 439.2.C and substitute the following:

C. Composition of Concrete

Design the concrete mix to conform to the following requirements:

1. Coarse Aggregate

Use coarse aggregate size No. 467, 67 or 57 for plain Portland cement concrete pavement.

Use size No. 67 or 57 coarse aggregate for continuous reinforced concrete pavement.

Separate size No. 467 in individual stockpiles of size No. 4 and size No. 67. Blend according to approved mix design proportions.

2. Fine Aggregate

Use fine aggregate that meets the requirements for size No. 10.

When using two sizes or sources of fine aggregate to produce the proper gradation, blend according to the approved design proportions.

Add the following to Subsection 439.2:

D. Reinforcing Steel

Provide deformed steel for bar reinforcement in accordance with [Section 853](#) of the Specifications or as shown on the plan details. Provide approved positioning and supporting devices (baskets and chairs) capable of securing and holding the reinforcing steel in proper position before and during paving. Store supporting devices in a manner to prevent corrosion and distortion.

1. Dowels

Provide smooth, straight dowels of the size shown on the plan details, free of burrs and conforming to the requirements of [Subsection 853.2.08](#).

For expansion joint construction, provide dowel caps on the lubricated end of each dowel bar. Provide dowel caps filled with a soft compressible material with enough range of movement to allow complete closure of the expansion joint.

2. Tie Bars

Provide straight deformed steel tie bars of the size shown on the plan details and conforming to the requirements of [Subsection 853.2.09](#). Provide either multiple-piece tie bars or single-piece tie bars as shown on the plan details. Provide multiple-piece tie bars composed of 2 pieces of deformed reinforcing steel with a coupling capable of developing a minimum tensile strength of 125% of the design yield strength of the deformed steel when tensile-tested in the assembled configuration.

3. Support Chairs

Provide bar supports capable of securing and holding the reinforcing steel in the proper position and conforming to the requirements of [Subsection 511.2, "Materials"](#). Except the use of mortar blocks are restricted to concrete lug anchor construction.

Add the following to Subsection 439.3.01:

B. Certified Concrete Plant Operator

If using onsite batch plant, have the Office of Materials and Research certify the concrete plant batcher and technician in accordance with [SOP 10, "Quality Assurance of Concrete Plants in Georgia"](#) before paving.

Delete Subsection 439.3.02 and substitute the following:

439.3.02 Equipment

A. Equipment Requirements

Provide equipment and tools to perform the work. Provide equipment that allows the paver to operate at a constant production rate and minimizes starting and stopping. The Engineer may limit the production rate or batch size if equipment does not keep pace with the other operations or causes poor workmanship.

B. Ramp Screeds and Hand Finishing Tools

Ramp screeds and hand finishing tools may be used instead of conventional mainline paving equipment.

C. Mixing Plant

If using onsite batch plant, have the Office of Materials and Research inspect and certify the mixing plant before paving. Approval and compliance of the plant will be in accordance with [SOP 10, "Quality Assurance of Concrete Plants in Georgia"](#) and [Section 500](#) of the Specifications.

Scales used to weigh concrete materials and the devices to measure water will meet the requirements of Subsection 500.3.02.C.3.

D. Spreading Equipment

Provide self-propelled mechanical spreader(s) capable of placing the concrete on the base material over the full width and depth of the pavement. Equip the spreader with a hopper or other type of spreading equipment that will distribute the concrete over the base material without segregation.

E. Hauling Equipment

Provide sufficient number of trucks to ensure adequate and continuous supply of concrete to the paver. Equip trucks hauling concrete from the plant to the paver with covers to protect the material from inclement weather and to reduce evaporation loss.

F. Paving Equipment

Ensure that equipment operating on the pavement has rubber-tired wheels or flat steel wheels. Wait to operate concrete or shoulder paving equipment on the pavement until the concrete is 14 days old or has 2,500 psi (15 MPa) compressive strength.

Paving equipment may be either slip-form or fixed form.

G. Surface Finish Equipment

Provide a self-propelled machine to produce the surface finish of the mainline and transverse plastic concrete grooving. Ensure that the equipment uses rectangular-shaped steel tines of the same size and uniform length. Use tines with a width between 0.08 in. (2 mm) and 0.130 in. (3.5 mm). Space the tines 3/8 in. (10 mm) apart, not to exceed 1/2 in. (13 mm). Hand-operated tining equipment that produces an equivalent texture may be used only on small or irregularly shaped areas or, when permitted, in emergencies due to equipment breakdown.

H. Curing Equipment

Provide a self-propelled machine for applying membrane curing compound using mechanically pressurized spraying equipment with atomizing nozzles. Provide equipment and controls that maintain the required uniform rate of application over the entire paving area. Provide a machine capable of containing drift of curing compound to outlying areas. Hand-operated pressurized spraying equipment with atomizing nozzles may only be used on small or irregular areas or, when permitted, in emergencies due to equipment breakdown.

I. Protective Equipment

Provide materials to protect the concrete edges and surface against rain, including:

- Standard metal forms or wood planks to protect the pavement edges
- Covering materials such as burlap or cotton mats, curing paper, or plastic sheeting material to protect the pavement surface

J. Reinforcing Steel Inserting Equipment (Tie Bars)

Provide inserting equipment that accurately inserts and positions reinforcing steel in the plastic concrete parallel to the profile grade and horizontal alignment in accordance to plan details.

Delete Subsection 439.3.05.B.6 and substitute with the following:

6. Deposit concrete near the formed joints. Place or discharge concrete only in the center of joint assembly.

Add the following to Subsection 439.3.05.B:

8. Arrange the operation so that leave-outs in continuous reinforced concrete pavement are unnecessary. The Engineer may grant permission for leave-outs in case of emergency provided a plan is approved for increasing the reinforcement, if required, at no additional expense to the Department.

Delete Subsection 439.3.05.D and substitute the following:

D. Protection From Rain

Protect the unhardened concrete from rain. See Subsection 439.3.02.I, "Protective Equipment".

When rain is imminent, stop paving operations and place forms against the sides of the pavement. Cover the surface of the unhardened concrete with the protective covering. Remove and replace areas damaged from rain with no additional expense to the Department.

Delete Subsection 439.3.05.G.4 and substitute the following:

4. When removing and replacing a pavement section, remove an area to the nearest transverse joint and the full width of the lane. Saw the sections to be removed to a vertical face and replace the concrete using a construction joint with dowels.

Delete Subsection 439.3.05.H.3 and substitute the following:

3. Longitudinal Sawed Joints

- a. Cut longitudinal sawed joints with a mechanical saw within three days after the concrete is placed and before traffic or equipment enters the pavement.
- b. When concrete is placed against existing concrete, begin sawing when concrete has hardened enough to prevent surface raveling, usually 4 hours after placement, but no later than 24 hours. Concrete should be sawn to a depth of 2 in. (50 mm).

Add the following to Subsection 430.3.05.H:

8. Concrete Lug Anchors for Continuously Reinforced Concrete Pavement (CRC)

Construct lug anchors in accordance with the plan details. Use concrete of the same Class as specified for the CRC pavement.

- a. Excavate the trenches for lug anchors after the base and when required by the plans, the asphalt interlayer is in place.
- b. Place the reinforcement steel in the trench according to plan details. Maintain clearances and support reinforcement steel using mortar blocks fabricated according to Subsection 511.2.1.g of the Specifications. Remove any earth material or other debris which may have dislodged and fallen into the trench before the reinforcement steel is placed.
- c. Construct lug anchors using one of the following two methods:
 - 1. Method 1: Construct lug anchors with pavement slab in one continuous placement of concrete to form a monolithic structure.
 - a. Place the concrete in layers not to exceed 18 in. (450 mm) thick.
 - b. Compact each layer with suitable vibrators according to Subsection 430.3.05.D, except place lug anchor concrete against earth, not forms.
 - c. Remove all loose earth before concrete placement and do not allow earth to be placed into the concrete during placement and compaction.
 - 2. Method 2: Construct lug anchors in advance of the construction of the pavement slab.
 - a. Construct lug anchors according to Subsection 430.3.05.K.8, except construct a shear key joint between the anchor and slab.
 - b. Construct shear key joint according to plan details.
 - c. During the time interval between completion of the lug anchor and placement of the concrete slab, keep the shear key joint and the protruding reinforcement steel clean and free of dirt or other materials which may weaken the bond between the lug anchors and the pavement slab.

Delete Subsection 439.3.06.I and substitute with the following:

I. Texture Depth Testing

Test the pavement surface to determine the texture depth by using GDT 72 at locations selected by the Engineer.

Transversely saw-groove areas with a surface texture depth less than 0.018 in. (0.5 mm) at no additional expense to the Department. Meet the depth requirement of 0.035 in. (0.9 mm) or greater.

Perform saw-grooving to meet the following dimensions:

Width	1/8 in. (3 mm)
Depth	3/16 in. (5 mm)
Spacing	1/2 in. (12 mm) center-to-center

Delete Subsection 439.4:

Add Subsection 439.4:

Portland cement concrete pavement (special) complete, in-place and accepted, will not be measured separately.

Reinforced concrete lug anchors below the bottom of the normal pavement will not be measured separately.

Delete Subsection 439.5:

Add Subsection 439.5:

Concrete pavement completed and accepted will be paid for under CONSTRUCTION COMPLETE.

Payment is full compensation for furnishing and placing materials, reinforcements, dowels, joint materials, supplies, and incidentals to complete the work including any reinforced concrete lug anchors (including furnishing and installing all materials, including reinforcement, for all excavation, for the satisfactory disposal of surplus material and for all incidentals necessary to complete the anchor).

Office of Materials and Research

GEORGIA DEPARTMENT OF TRANSPORTATION

STATE OF GEORGIA

SPECIAL PROVISION

Project Number: CSNHS-0008-00(415)

P.I. Number: 0008415

Fulton County

Section 442—Roller Compacted Concrete Pavement

442.1 General Description

This work includes constructing pavement composed of Roller Compacted Concrete (RCC) on a prepared subgrade or subbase course. Follow the requirements of these Specifications and conform to the lines, grades, thickness, and cross sections shown on the Plans or as directed by the Engineer.

442.1.01 Definitions

General Provisions 101 through 150.

442.1.02 Related References

A. Standard Specifications

Section 106—Control of Materials

Section 430—Portland Cement Concrete Pavement

Section 500—Concrete Structures

B. Referenced Documents

ASTM C 1435

AASHTO T 22

AASHTO T 180, Method D

QPL 10

GDT 59

442.1.03 Submittals

Submit the following to the Engineer at least 35 days before start of any production of RCC:

A. Concrete Mix Design

Submit a mix design prepared by a qualified testing laboratory. The Engineer will transmit the design to the Office of Materials and Research for approval.

Include details on aggregate gradation, cementitious materials, admixtures (if used), compressive strengths, required moisture and density to be achieved and quantities of individual materials per cubic yard for the mix design.

B. Paving Plan

Submit paving procedures describing direction of paving operations, paving widths, planned longitudinal and transverse cold joints, curing methods and patterns and description of all equipment.

442.2 Materials

Ensure that materials meet the requirements of the following Specifications:

Material	Section
Coarse Aggregate, Class A or B Crushed Stone or Gravel	800
Fine Aggregate, Size No. 10	801.2.02
Portland Cement, Type 1	830.2.01
Portland Pozzolan cement	830.2.03
Chemical Admixtures	831.2.02
Fly Ash and Slag	831.2.03
Curing Agents	832
Joint Fillers and Sealers	833
Low Modulus Silicone Sealant for Roadway Construction Joints	833.2.06
Water	880.2.01

A. Fly Ash

Ensure the use of fly ash conforms to Subsection 430.2.A.1, 2 and 4, “Fly Ash” and that the fly ash mix conforms to Subsection 442.3.06, “Quality Acceptance”.

B. Granulated Iron Blast-Furnace Slag

Ensure the use of slag conforms to Subsection 430.2.B.1, 2 and 4, “Granulated Blast-Furnace Slag” and that the slag mix conforms to Subsection 442.3.06, “Quality Acceptance”.

C. Composition of RCC

1. Aggregates

Use aggregates manufactured to meet the gradation at the quarry or blended at the plant site to produce the desired results. Use aggregates that are well graded without gradation gaps and conform to the following gradation:

Sieve Size	Percent Passing By Weight
1 in (25 mm)	100
3/4 in (19 mm)	90 – 100
1/2 in (12.5 mm)	70 – 100
3/8 in (9.5 mm)	60 – 85
No. 4 (4.75 mm)	40 – 60
No. 16 (1.18 mm)	20 – 40
No. 100 (150 µm)	6 – 18
No. 200 (75 µm)	2 – 8

Produce evidence that the proportions have the potential for strength development at 28 days as required in Subsection 442.3.06.B, “Approval of Mix Design Proportions”.

442.3 Construction Requirements

442.3.01 Personnel

General Provisions 101 through 150.

442.3.02 Equipment

Provide equipment and tools to construct RCC that will produce a completed pavement meeting the requirements for mixing, transporting, placing, compacting, finishing, and curing as provided in this specification. All equipment will be on hand and approved by the Engineer before work can proceed.

A. Mixing Plant

Produce an RCC pavement mixture in the proportions defined by the approved mix design and within the specified tolerances.

Capacity of the plant will be sufficient to produce a uniform mixture at a rate compatible with the placement equipment.

1. Pugmill Plant

- a. Pugmill plant shall be a central plant with a twin shaft pugmill mixer, capable of batch or continuous mixing.
- b. Equip plant with synchronized metering devices and feeders to maintain the correct proportions of aggregates, cement, fly ash and water.
- c. The pugmill plant will also meet the following:
 - 1) Aggregate Storage
 - a. If previously blended aggregate is furnished, storage may be in a stockpile from which it is fed directly to a conveyor feeding mixer.
 - b. If aggregate is furnished in two size groups, aggregate separation must be provided at the stockpile.
 - 2) Aggregate Bins
 - a. Control feed rate by a variable speed belt or operate gate calibrated to accurately deliver any specified quantity of material.
 - b. If two aggregate size stockpile sources are used, the feed rate from each bin shall be readily adjustable to change aggregate proportions, when required.
 - c. Feed rate controls must maintain the established proportions of aggregate from each stockpile bin when the combined aggregate delivery is increased or decreased.
 - 3) Plant Scales
 - a. If utilized, for any weigh box or hopper will be either of beam or springless dial type, and be sensitive to 0.5 percent of the maximum load required.
 - b. Provide beam-type scales that have a separate beam for each aggregate size, with a single telltale actuated for each beam, and a tare beam for balancing hopper.
 - c. Belt scales will be of an approved design.
 - d. Provide standard weights accurate to plus or minus 0.1 percent for checking plant scales.
 - 4) Cement, Fly Ash or Slag Material Storage
 - a. Provide separate and independent storage silos for Portland cement, fly ash or slag.
 - b. Identify clearly each silo to avoid confusion during silo loading.
 - 5) Cement, Fly Ash or Slag Feed Unit

To assure a uniform and accurate quantity of cementitious materials enters the mixer, provide satisfactory means of dispensing Portland cement, fly ash or slag, volumetrically or by weight.
 - 6) Water Control Unit

- a. Measure by weight or volume the required amount of water for the approved mix.
 - b. Equip the unit with an accurate metering device.
 - c. Keep RCC mixture at optimum moisture by having the rate of water added adjustable.
- 7) Gob Hopper

For continuous operating pugmills, attach a gob hopper to the end of the final discharge belt to temporarily hold the RCC discharge to allow the plant to operate continuously.

2. Central Mix Batch Plant

Central mix batch plant may be used in RCC work meeting the requirements of Subsection 500.3.04.E of the Specifications.

3. Dry Batch Plant

- a. A dry batch plant meeting the requirements of Subsection 500.3.04.E of the Specifications may be used on projects with less than 5000 cubic yards of RCC.
- b. RCC may be mixed at a central point or wholly or in part in truck mixers as provided in Subsection 500.3.04.E of the Specifications.

B. Paver

Place RCC with an asphalt paver meeting the following requirements:

1. Equip the paver with compacting devices capable of producing a RCC pavement with a minimum of 90% of the maximum density in accordance with AASHTO T 180, Method D.
2. Spread and finish the RCC material without segregation, to the required thickness, smoothness, surface texture, cross-section and grade using a paver of suitable weight and stability.

C. Compactors

1. For primary compaction, use self-propelled smooth steel drum vibratory rollers having minimum weight of 10 tons (9.07 Mg).
2. For finish rolling as required for final compaction or for removing roller marks, use a steel drum roller, operating in static mode, a rubber tired roller or combination roller.
3. For compacting areas inaccessible to large rollers, use walk-behind vibratory rollers or plate tampers.

D. Haul Trucks

1. Provide sufficient number of trucks to ensure adequate and continuous supply of RCC material to paver.
2. Equip trucks hauling RCC material from the plant to the paver with covers to protect the material from inclement weather and to reduce evaporation losses.

E. Water Trucks

1. Throughout the paving and curing process, have at least one water truck or other similar equipment on-site and available.
2. Equip the water truck with a spreader pipe containing fog nozzles capable of evenly applying a fine mist of water to the surface of the RCC without damaging the final surface.

442.3.03 Preparation

Prepare the subgrade/subbase as required by the Plans and Specifications before placing the RCC.

Ensure that the foundation immediately under the RCC pavement and the areas supporting the paving equipment will not contribute to deficient pavement thickness or excessive yield losses.

442.3.04 Fabrication

General Provisions 101 through 150.

442.3.05 Construction

A. Mixing RCC

Use the same mix design and materials for the entire project. If the source of cement, fly ash, slag, or aggregates is changed, suspend construction and submit a new mix design to the Engineer for approval.

1. Mixing Time

- a. Assure complete and uniform mixing of all ingredients.
- b. The volume of RCC material in the mixing chamber should not exceed the manufacturer's rated capacity for dry concrete mixtures.
- c. Keep sides of the mixer and mixer blade surfaces free of hardened RCC and other materials.
- d. Check mixer blades routinely for wear and replace if wear is sufficient to cause inadequate mixing.

2. Mixing Ingredient Tolerances

Ensure that mixing plant receive the quantities of individual ingredients to within the following tolerances:

Material	Variation by Weight
Cementitious Materials	± 2.0%
Water	± 3.0%
Aggregates	± 4.0%

3. Plant Calibration

- a. Prior to RCC production, provide a complete and comprehensive calibration of the plant in accordance to the manufacturer's recommendation.
- b. Concrete batch plants currently listed on QPL 10, the calibration requirement is waived.

Supply daily plant records of production and quantities of materials used that day to the Engineer. These records may be used as a check on plant calibration.

B. Transporting RCC

Transport RCC pavement material from the plant to the paver as follows:

1. Use dump trucks fitted with retractable protective covers for protection from inclement weather or excessive evaporation.
2. Dump the trucks clean with no buildup or hanging of RCC material in the corners.
3. Deposit the RCC material directly into the hopper of the paver or secondary distribution system which deposits the material into the paver hopper.

C. Placing RCC

1. Subgrade/Subbase Condition

- a. Keep subgrade/subbase surface clean and free of foreign material, ponded water and frost prior to RCC placement.
- b. Uniformly moisten subgrade/subbase at the time of RCC placement.
- c. If the subbase becomes dry, uniformly water, but the method of watering used will not form mud or pools of freestanding water.

2. Paver Requirements
 - a. Adjust the paver and regulate the speed to prevent segregation and provide a surface course that is smooth and continuous without tears and pulling. Limit the spread of the RCC to a length that can be compacted and finished within the appropriate time limit under the prevailing air temperature, wind, and climatic conditions.
 - b. Proceed in a steady, continuous operation with minimal starts and stops.
 - c. Regulate speed to assure a constant supply of RCC material in the hopper.
 - d. Maintain RCC material above the auger shaft at all times during paving.
3. Lift Thickness

Construct pavements greater than 10 in (250 mm) in two lifts of equal thickness.
4. Adjacent Lane Placement
 - a. Place adjacent paving lanes within 60 minutes.
 - b. If more than 60 minutes has elapsed between placements of adjacent lanes, the vertical joint will be considered a cold joint. Prepare the cold joint in accordance with Subsection 442.3.05.E.2, "Cold Vertical Joints".
 - c. At the discretion of the Engineer, this time may be increased or decreased depending on the use of set retarding admixtures or the ambient weather conditions of temperature, wind, and humidity.
5. Multiple Lift Placement
 - a. The thickness of each lift will meet the requirements of Subsection 442.3.05.C.3, "Lift Thickness".
 - b. Place second lift within 60 minutes of the completion of the first lift.
 - c. If more than 60 minutes has elapsed, the interface between the first and second lift will be considered a cold joint. Prepare cold joint in accordance with Subsection 442.3.05.E.4, "Horizontal Cold Lift Joints".
 - d. At the discretion of the Engineer, this time may be increased or decreased depending on the use of set retarding admixtures or the ambient weather conditions of temperature, wind, and humidity.
 - e. To reduce the opportunity for cold joints to develop, the use of multiple pavers in tandem formation is advantageous.
6. Hand Spreading
 - a. Limit hand spreading, broadcasting, or fanning to immediately behind the paver and before compaction.
 - b. Remove any segregated coarse aggregate from the surface before compaction.
7. Segregation
 - a. If segregation occurs in the RCC during paving operations, cease the spreading until the cause is determined and corrected to the satisfaction of the Engineer.
 - b. If the Engineer determines the segregation to be severe, remove and replace the segregated area at no additional cost.

Place RCC in a pattern so that the curing water from the previous placements will not pose a runoff problem on the fresh RCC surface or on the subbase layer.

D. Compacting

1. Immediately begin compaction behind the placement of RCC material and complete within 60 minutes of the start of mixing at the plant.
2. This time may be increased or decreased depending on the use of set retarding admixtures or ambient weather conditions of temperature, wind and humidity.
3. Plan operations and supply sufficient rollers to ensure these criteria are met.
4. Determine the sequence and number of passes by vibratory and non-vibratory rolling to obtain the specified density and surface finish.

5. Operation of rollers in the vibratory mode while stopped or reversing direction is not allowed.
6. Using rubber tire rollers for final compaction to knead and seal the surface is permissible.
7. Rolling Longitudinal and Transverse Joints:
 - a. Do not operate roller within 12 in. (300 mm) of the edge of a freshly placed lane until the adjacent lane is placed.
 - b. Within the allowable time roll together both edges of the two lanes.
 - c. When a cold joint is planned, roll the complete lane and follow cold joint procedures as specified in Subsection 442.3.05.E.2, "Cold Vertical Joints".
 - d. Provide additional rolling for longitudinal joints with a vibratory roller as necessary to produce the specified density for the full depth of the lift and provide a tight smooth transition across the joint.
 - e. Smooth out any uneven marks left during the vibratory rolling utilizing a non-vibratory or rubber tire roller.
 - f. Roll until a smooth, flat surface, free of tearing and cracking is obtained.
 - g. Avoid displacement of RCC pavement by operating the speed of the rollers slow enough at all times.
 - h. Correct any displacement of RCC pavement resulting from reverse direction of the roller or from any other causes.
8. Density Requirements:
 - a. Perform in-place field density tests in accordance with GDT-59, direct transmission, as soon as possible, but no later than 30 minutes after completion of rolling. Only wet density will be used for evaluation.
 - b. In-place field density will be not less than 98% of the average maximum laboratory density obtained according to AASHTO T 180, Method D, based on a moving average of five consecutive tests, with no test below 95%.
 - c. RCC properly placed and compacted, but not meeting these requirements will be cored and tested at no additional cost.
 - d. If tested area achieves the 28 day design strength as outlined in Subsection 442.3.06.D, "Concrete Strength Acceptance", it will be paid for at full price.
 - e. Areas that fail the strength test will be removed and replaced at no additional cost.

E. Joints

1. Fresh Vertical Joints:
 - a. A vertical joint is considered a fresh joint when an adjacent RCC lane is placed within 60 minutes of placing the previous lane, with time adjusted depending on use of retarders or ambient conditions. Fresh joints will not require the treatment specified for cold joints.
 - b. Construct joints to assure continuous bond between new and previously placed lanes.
2. Cold Vertical Joints:

Note: Vertical joints that are constructed utilizing a drop extension or edging shoe are exempt from the following requirement when placed up to 15 degrees from vertical.

- a. Cold joints are any planned or unplanned construction joint in the RCC pavement that does not qualify as fresh joints.
Treat longitudinal and transverse cold joints as followed:
 - 1) Cut the joint vertically full depth. Cut vertically at least 6 in. (150 mm) from the exposed edge.
 - 2) The edge of cold joints cut within 2 hours of placing the RCC pavement may be cut with an approved wheel cutter, or motor grader or other approved method provided that no edge raveling occurs.
 - 3) Edges of cold joints cut after 2 hours of placing the RCC pavement, cut to 1/4 to 1/3 of the depth of the RCC pavement and excess material removed.

- 4) If the excess material cannot be removed without causing tearing and raveling, cut full depth.
 - b. Clean the joint of any loose or foreign material prior to placing fresh RCC material against a compacted cold vertical joint.
 - c. Before placement of fresh RCC, wet the compacted cold joint to prevent excess loss of moisture.
3. Fresh Horizontal Joints
 - a. For multi-layer construction, a horizontal joint is considered a fresh joint when an subsequent RCC lift is placed within 60 minutes of placing the previous lift, with time adjusted depending on use of retarders or ambient weather conditions.
 - b. Clean the surface of all loose material and moisten the surface prior to placement of the subsequent lift.
 4. Horizontal Cold Lift Joints
 - a. For horizontal cold joints, clean all loose material and moisten the surface prior to placement of the subsequent lift.
 - b. The Engineer or Plans may require use of a cement slurry or grout between lifts. If required, apply supplementary bonding materials immediately prior to placement of the subsequent lift.
 5. Control Joints:

Joint locations shall be shown on the Plans or as directed by the Engineer.

 - a. Early entry saws should be utilized as soon as possible behind the rolling operation and set to the manufacturer's recommendation.
 - b. Saw cut control joints to 1/4 depth of the compacted RCC pavement.
 - c. Saw as soon as possible without causing raveling or other damage to the pavement, but no later than 18 hours after placement.
 6. Joints at Structures

Treat joints between RCC pavement and concrete structures as cold vertical joints.

F. Finishing

1. The finished surface of the RCC pavement, when tested with a 10 foot (3 m) straight edge or crown surface template, will not vary by more than 1/4 inch (6 mm) at any one point.
2. When the surface smoothness is outside of the specified tolerance, grind the surface to within the tolerance by use of self-propelled diamond grinders at no additional cost.
3. Milling to obtain a final riding surface is not acceptable.

G. Curing

Immediately after final rolling and compaction testing, keep the surface of the RCC pavement continuously moist for 7 days or until an approved curing method is applied.

1. Water Cure:
 - a. Apply water cure using water truck equipped with misting spray nozzles, soaking hoses, sprinkler system or other means that will assure a uniform moist condition to the RCC.
 - b. Apply moisture in a manner that will not wash out or damage the surface of the finished RCC pavement.
2. Curing Compound:
 - a. Apply curing compound as specified in Subsection 430.3.05.L.1 of the Specifications.
 - b. Ensure the application provides a uniform void-free membrane across the entire RCC pavement surface.
3. White Polyethylene Sheeting

Use sheet material as specified in Subsection 430.05.L.2 of the Specifications

H. Sealing Joints

If required by the Plans or directed by the Engineer, seal joints in accordance to Subsection 430.3.05.M, “Seal the Joints” of the Specifications.

I. Permitting Traffic on Pavement

Before using the pavement as a haul road for loaded or unloaded vehicles:

1. Protect the RCC from vehicular traffic during the curing period.
2. Ensure that compressive strength tests show the RCC has developed at least 2000 psi (14 MPa) and is at least 4 days old.
3. If required by the Plans or directed by the Engineer, seal the joints before permitting vehicles or equipment on the pavement.

442.3.06 Quality Acceptance

A. Concrete Mixing

Ensure mixing of RCC conforms to the requirements of Subsection 442.3.05.A, “Mixing RCC”.

B. Approval of Mix Design Proportions

The Office of Materials and Research will review concrete mix designs and will verify compressive strength development.

The Department will approve material combinations and mix designs using approved materials and complying with Subsection 442.2, “Materials” and the following:

1. Compressive Strength

Prepare and test 6 cylinders according to ASTM C 1435 and AASHTO T 22 to determine the 28 day compressive strength for RCC.

The mix design will demonstrate a compressive strength of 4000 psi (28 MPa) at 28 days.

C. Thickness

The Engineer will designate pavement areas to be examined for depth measurement compliance with the Plan and Specifications.

The Engineer will evaluate areas deficient by more than 1/2 in (13 mm) thick. If the Engineer requires removal, remove and replace the pavement in full cross sections according to Plan requirements. The Engineer may require a reduction in payment if removal and replacement is not required.

D. Concrete Strength Acceptance

RCC pavement not meeting density requirements outlined in Subsection 442.3.05.D.8, “Density Requirements” will be accepted based on compressive strength development at 28 days. The compressive strength value shall be at least 3,500 psi (25 MPa).

442.3.07 Contractor Warranty and Maintenance

General Provisions 101 through 150.

442.4 Measurement

No separate measurement will be made for this item.

442.4.01

General Provisions 101 through 150.

442.5 Payment

The work will be paid for under CONSTRUCTION COMPLETE. Includes providing materials, equipment, and labor, mixing, transporting, handling, placing, compaction and providing incidentals to complete the work.

442.5.01 Adjustments

The most current Mean Item Summary Unit Price per square yard of RCC pavement will be used as the assumed value to adjust for RCC pavement accepted with a 28 day compressive strength or thickness deficiency.

Office of Materials and Research

Georgia Department of Transportation

State of Georgia

Special Provision

Project Number: CSNHS-0008-00(415)

P.I. Number: 0008415

Fulton County

Section 500—Concrete Structures

Delete Subsection 500.1 and substitute the following:

This work consists of manufacturing and using High Performance Portland cement concrete to construct precast-prestressed concrete bridge members as shown in the plans and using normal weight Portland cement concrete to construct structures as shown in the Plans.

Add the following to Subsection 500.1.02.A:

Section 831—Admixtures

Add the following to Subsection 500.1.02.B:

AASHTO T 277

Add the following to Subsection 500.1.03.A:

High Performance Concrete Mix Designs

The Fabricator is responsible for all concrete mix designs. Ensure that concrete mixes contain enough cement to produce workability within the water-cement ratio specified in Table 1A—High Performance Concrete Mix Table, below.

Submit a mix design for approval to the Office of Materials and Research. Include the sources and actual quantity of each ingredient and laboratory results that demonstrate the ability of the design to attain both the required compressive strength and chloride permeability at 56 days.

Include laboratory compressive strength test results of at least eight test cylinders prepared and cured according to AASHTO T 126. Ensure these test cylinders are made from two or more separate batches with an equal number of cylinders made from each batch.

Also include laboratory chloride permeability test results of at least two test specimens prepared and tested according to AASHTO T 277. Ensure these test specimens are made from two or more separate batches with an equal number of specimens made from each batch.

Table 1A—High Performance Concrete Mix Table

English									
Class of Concrete	Coarse Aggregate Size No.	(1) Minimum Cement Factor (lbs/yd ³)	Maximum Water/Cement ratio (lbs/lbs)	(2) Slump Acceptance Limits (in) Lower-Upper		Entrained Air Acceptance Limits (%) Lower-Upper		(3) Minimum Compressive Strength at 56 days (psi)	Maximum Chloride Permeability at 56 days (Coulombs)
"AAA HPC"	67	650	.330	2	7	3.5	6.5	Beams – As shown on the Plans Piling – 5000	Beams – 3,000 Piling – 2,000
Metric									
Class of Concrete	Coarse Aggregate Size No.	(1) Minimum Cement Factor (kg/m ³)	Maximum Water/Cement ratio (kg/kg)	(2) Slump acceptance Limits (mm) Lower-Upper		Entrained Air Acceptance Limits (%) Lower-Upper		(3) Minimum Compressive Strength at 56 days (MPa)	Maximum Chloride Permeability At 56 days (Coulombs)
"AAA HPC"	67	386	.330	50	180	3.5	6.5	Beams – As shown on the Plans Piling – 35	Beams – 3,000 Piling – 2,000

- Determine the slump acceptance after the addition of high-range water reducer.
- Determine the minimum compressive strength at 56 days using 4 in. diameter x 8 in. high (100 mm x 200 mm) cylinders.

Add the following to Subsection 500.2 Table 3:

Fly Ash	831.2.03.A.1
Silica Fume	831.2.03.A.4

Add the following note to Subsection 500.2 Table 3:

- Use Type I or III Portland cement in High Performance concrete. Do not use air-entraining cement.

Add the following to Subsection 500.3.04.D.4:

- For High Performance concrete, fly ash may be used as an additive at an addition rate not to exceed 15% of the cement by weight.

Add the following to Subsection 500.3.04.D:

- Silica Fume

Silica Fume may be used as an additive at an addition rate not to exceed 10% of the cement by weight.

Delete Subsection 500.5 and substitute with the following:

500.5 Payment

Payment will be made under CONSTRUCTION COMPLETE. Includes incidentals, and direct and indirect costs, to complete the Work.

500.5.01 Adjustments

A. Contractor Costs

Assume the following costs:

1. Costs related to rejected concrete and removing rejected concrete
2. Costs of forming an approved construction joint, removing a partial pour, or completing other remedial measures requested by the Engineer unless the fault lies solely with the Department
3. Costs of repairing, removing, and replacing falsework as directed by the Engineer
4. Costs of repairing, removing, or replacing forms
5. Costs of air-blown mortar to repair honeycombed areas, if required by the Engineer
6. Costs of using a higher class of concrete to widen existing bases or bases and pavements

B. Profilograph Testing

The Department will conduct profilograph testing of bridge decks and approach slabs only twice per bridge at no cost to the Contractor.

The Department will conduct additional profilograph testing at the cost of \$500 per test.

C. Plastic Shrinkage Crack Repair

The Engineer will determine how to repair cracks caused by plastic shrinking. Repair cracks at no cost to the Department.

D. Plan Quantities

For all bridges (except seal concrete), concrete culverts, headwalls, and retaining walls, the quantities shown on the Contract Plans, including Standard Plans, will be considered the Base Pay Quantity.

For seal concrete, the Plan quantities are approximate and are for estimating purposes only. The quantities will not be considered as Base Pay Quantities.

Calculated additions or deductions will be applied to the Base Pay Quantity when the Engineer makes authorized changes. Changes include, but are not limited to, authorized changes in the following:

- Footing dimensions
- Lengthening or shortening of concrete culverts
- Correcting Plan Quantities
- Dimension errors
- Multi-barrel culvert wall thicknesses
- Lengthening or shortening bridge columns
- Raising or lowering foundations

Calculations of the Base Pay Quantity and any changes will be made as follows:

7. No deductions will be made for the volume of concrete used by scorings, panels, and chamfers if the individual areas are less than 1 in² (625 mm²).
The volume of concrete in fillets of the same area will be neglected.
8. The volume of structural steel and of steel and concrete piling encased in concrete will be deducted.
9. The volume of timber piling encased in concrete will be deducted on the basis of 0.8 ft³/linear foot (0.07 m³/linear meter) of pile.
10. No deduction will be made for the volume of concrete displaced by the following:
 - Steel reinforcement
 - Shear connectors
 - Floor drains (unless they are paid for as separate Pay Items)
 - Incidentals such as expansion material
 - Joint sealing compound
 - Utility thimbles and hangers

E. Filler Concrete

Filler concrete, measured as described in [Subsection 500.4.01.B.1, “Bridges, Concrete Culverts, Headwalls, and Retaining Walls.”](#) will be paid at 40 percent of the Contract Price per cubic meter for Class A Concrete or Class AA Concrete.

F. Seal Concrete

If there is no Contract Price for seal concrete, payment will be per cubic yard (meter), measured as described in [Subsection 500.4.01.B.2, “Seals,”](#) and will be paid at 60 percent of the Contract Price per cubic yard (meter) for Class A concrete.

G. Lump Sum Payment Adjustments

Adjust the payment as follows:

1. Authorized Change Adjustments

When authorized changes are made as described in [Subsection 500.5.01.D, “Plan Quantities,”](#) the lump sum payment may be adjusted on a pro rata basis or according to [Section 104](#) and as determined by the Engineer.

The Plans show tabulated quantities as a service. This does not relieve any responsibility to conform to Plan details.

2. Optional Plan Feature Adjustments

If exercising an optional Plan feature, the Base Pay Quantity will not be changed if it is the only quantity change involved.

However, if other changes are necessary, the quantity change resulting from the optional feature will be considered in the necessary quantity adjustments.

3. Falsework for Post-Tensioned Box Girder Bridge Adjustments

When the falsework is completed for post-tensioned box girder bridges, 20 percent of the Lump Sum superstructure concrete price will be paid.

Additional payments made as the concrete is placed must be adjusted for the payment for falsework. In other words, payment for concrete placed will be based on 80 percent of the superstructure bid price.

4. When Metal Deck Forms are used and have been placed, payment in the amount of 5% of the Lump Sum Superstructure Concrete price will be made. For Post-Tensioned Box Girder Bridges, this percentage (5%) will apply to that part of the superstructure concrete in the top slab of the box only.

DEPARTMENT OF TRANSPORTATION
STATE OF GEORGIA

SPECIAL PROVISION

Project Number: CSNHS-0008-00(415); Fulton County
P.I. Number: 0008415

Section 511 – Reinforcement Steel

Add the following to 511.2 Materials, B. Fabrication:

2. **Reinforcement Steel Couplers.** When couplers are indicated on the Plans, use Lenton Mechanical Bar Splices, Bar-Grip Systems manufactured by Dayton Barsplice, Inc., Dywidag Thread Bar Reinforcing Systems, or equal.

For the coupler system, develop a minimum of 125% of the guaranteed yield strength of the reinforcing steel to be spliced. Limit the total slip of the reinforcing bars within the splice sleeve after loading to 30 kips per square inch (207 MPa) and relaxing to 3 kips per square inch (21 MPa) to no more than the following, as measured between gauge points clear of the splice sleeve: 0.010 of an inch (.25mm) for reinforcing bars no. 14 (43) or smaller, or 0.030 of an inch (.76mm) for reinforcing bars no. 18 (57).

Make test specimens in the presence of the Engineer or his authorized representative using reinforcing steel consigned for the work. A test specimen consists of a splice made at the job site to connect two 24 inch (600mm) or longer bars using the same splice materials, position, location, and equipment, and following the same procedures to be used to make splices in the work. Prior to incorporating couplers into the work, make and test three specimens that meet the above criteria.

To qualify a coupler product as an equal to those listed above, perform an initial test using five sample couplers selected at random from the couplers consigned to the work. The coupler product is qualified if test results indicate compliance with the requirements shown above. When a test representing a Lot of couplers fails to meet the strength requirement of 125% of the guaranteed yield strength of the reinforcing steel, test four more couplers. If all four tests indicate compliance with the strength requirement, the remaining couplers in the Lot may be incorporated into the work.

Perform all testing required above by the Office of Materials and Research or at a testing laboratory approved by the Department.

If threaded couplers are used, equip them with approved devices which will prevent rotation after installation.

After installation, clean all couplers with a power wire brush or by other approved methods and recoat the couplers with a material prepared and recommended by the coating manufacturer.

Install couplers in strict accordance with the coupler manufacturer's instructions and as approved by the Engineer.

All costs for the couplers, test samples (including reinforcing steel for tests) and testing of couplers shall be included in the costs of reinforcing steel.

Delete Subsection 511.4 and substitute the following:

511.4 Measurement

No separate measurement will be included for this item.

511.4.01 Limits

A. Construction of Minor Items

No measurement or payment will be made for the cost of bar reinforcement steel used in constructing minor items. Payment shall be made under CONSTRUCTION COMPLETE.

B. Prestressed Concrete Bridge Members

Bar reinforcement steel in prestressed concrete bridge members will be considered a component part of the members. Payment shall be made under CONSTRUCTION COMPLETE.

C. Handrail End Posts

Reinforcement steel in handrail end posts that are a part of the superstructure or substructure will be considered part of the superstructure or substructure items. Payment shall be made under CONSTRUCTION COMPLETE.

D. Lap Splices

Extra reinforcement steel in lap splices permitted for convenience at splices not shown on the Plans will not be measured for payment. Payment shall be made under CONSTRUCTION COMPLETE.

Delete Subsection 511.5 and substitute the following:

511.5 Payment

Payment will be made under CONSTRUCTION COMPLETE. Includes full compensation for all costs to conform to approved plan details, reinforcement steel in concrete bridges, culverts, concrete handrailings, concrete parapets, barriers, and other items, including minor items, requiring reinforcing steel to complete the Item.

**DEPARTMENT OF TRANSPORTATION
STATE OF GEORGIA**

Supplemental Specification

Project Number: CSNHS-0008-00(415)

P.I. Number: 0008415

Fulton County

Section 550—Storm Drain Pipe, Pipe-Arch Culverts, and Side Drain Pipe

Delete Section 550 and Substitute the following:

550.1 General Description

This work includes furnishing and installing the following:

- Storm drain pipe
- Pipe-arch and elliptical culverts
- Side drain pipe flared end sections
- Tapered pipe inlets

Install structures according to the Specifications and the details shown on the Plans, or as directed by the Engineer.

550.1.01 Definitions

General Provisions 101 through 150.

550.1.02 Related References

A. Standard Specifications

[Section 205—Roadway Excavation](#)

[Section 207—Excavation and Backfill for Minor Structures](#)

[Section 208—Embankments](#)

[Section 645—Repair of Galvanized Coatings](#)

[Section 815—Graded Aggregate](#)

[Section 834—Masonry Materials](#)

[Section 840—Corrugated Aluminum Alloy Pipe](#)

[Section 841—Iron Pipe](#)

[Section 843—Concrete Pipe](#)

[Section 844—Steel Pipe](#)

[Section 845—Smooth Lined Corrugated High Density Polyethylene \(HDPE\) Culvert Pipe](#)

[Section 846—Polyvinyl chloride \(PVC\) Drain Pipe](#)

[Section 847—Miscellaneous Pipe](#)

[Section 848—Pipe Appurtenances](#)

B. Referenced Documents

General Provisions 101 through 150.

GDOT Manual on Drainage Design for Highways

Ga. Std. 1030D

Ga. Std. 1030P

550.1.03 Submittals

General Provisions 101 through 150.

550.2 Materials

Ensure that materials meet the requirements of the following Specifications:

Material	Section
Backfill Materials	207
Graded Aggregate	815.2.01
Reinforced Concrete Pipe	843.2.01
Nonreinforced Concrete Pipe	843.2.02
Mortar And Grout	834.2.03
Bituminous Plastic Cement	848.2.05
Rubber Type Gasket Joints (Concrete Pipe)	848.2.01
Preformed Plastic Gaskets	848.2.06
Corrugated Steel Pipe	844.2.01
Bituminous Coated Corrugated Steel Pipe	844.2.02
Corrugated Aluminum Alloy Pipe	840.2.01
Bituminous Coated Corrugated Aluminum Pipe	840.2.03
Aluminized Type 2 Corrugated Steel Pipe	844.2.06
Ductile Iron Pipe, Fittings and Joints	841
Precoated, Galvanized Steel Culverts	844.2.05
Smooth Lined Corrugated High Density (HDPE) Polyethylene Culvert Pipe	845.2.01
Polyvinyl Chloride (PVC) Profile Wall Drain Pipe	846.2.01
Polyvinyl Chloride (PVC) Corrugated Smooth Interior Drain Pipe	846.2.02
Miscellaneous Pipe	847

Use any of the following types of pipe:

- Reinforced concrete
- Nonreinforced concrete
- Corrugated steel or Aluminum
- Smooth-lined corrugated high density polyethylene (HDPE)
- Ductile iron
- Polyvinyl Chloride (PVC) Profile Wall Drain Pipe
- Polyvinyl Chloride (PVC) Corrugated Smooth Interior Drain Pipe

Use the type of pipe designated on the Plans, or acceptable alternate types when applicable. For a display of acceptable alternate pipe types see Selection Guideline for Culvert, Slope and Underdrain Pipe in Chapter 10 – Material Selection of the Department’s Manual on Drainage Design for Highways. This document summarizes general applications for pipe.

For concrete, corrugated steel and aluminum pipe see Ga. Std. 1030D for minimum thicknesses, minimum cover, maximum fill, allowable pipe diameters and trench construction detail.

For HDPE and PVC pipe see Ga. Std. 1030P for minimum cover, maximum fill, allowable pipe diameters and trench construction detail.

550.2.01 Delivery, Storage, and Handling

General Provisions 101 through 150.

550.3 Construction Requirements

550.3.01 Personnel

General Provisions 101 through 150.

550.3.02 Equipment

General Provisions 101 through 150.

550.3.03 Preparation and Backfill

Before installing pipe, shape the foundation material as shown on the Plans.

Prepare structure excavations and foundation according to [Section 207](#). Except, for HDPE and PVC pipe use the following requirements for backfill:

1. Cross drain applications use material that meets [Subsection 815.2.01](#).
2. Longitudinal and side drain applications use material according to [Section 207](#). Except, when Type I backfill material is required use Class II B2 soil or better per [Subsection 810.2.01](#).

550.3.04 Fabrication

General Provisions 101 through 150.

550.3.05 Construction

A. Drainage

Provide necessary temporary drainage. Periodically remove any debris or silt that constricts the pipe flow to maintain drainage throughout the life of the Contract.

B. Damage

Before allowing construction traffic over a culvert, protect the structure by providing sufficient depth and width of compacted backfill. Repair damage or displacement from construction traffic or erosion that occurs after installing and backfilling at no additional cost to the Department.

C. Installation

1. Concrete Pipe

Lay sections in a prepared trench with the socket ends pointing upstream. To join sections, use any of the following joint types:

- Mortar
- Bituminous plastic cement
- Rubber gasket
- Preformed flexible sealant

If using mortar and bituminous plastic cement joints:

- a. Fill the annular space with the joint material and wipe the inside of each joint smooth.

- b. Construct mortar joints in the same manner, but thoroughly wet the annular space before filling it with joint material.
 - c. Install rubber and preformed flexible sealant joints according to the manufacturer's recommendations.
2. Ductile Iron Pipe
Lay pipe sections in a prepared trench, with bells pointing upstream. Construct joints according to [Subsection 841.2.02.A](#).
 3. Corrugated Aluminum or Steel Pipe and Pipe-Arches
Lay pipe sections in a prepared trench, with outside laps of circumferential joints pointing upstream and longitudinal joints at the sides. Join the sections with coupling bands, fastened by two or more bolts. Before backfilling the structure:
 - a. Repair exposed base metal in metal coating according to [Section 645](#).
 - b. Recoat exposed base metal in bituminous coating with asphalt.
 4. Smooth-Lined Corrugated HDPE Pipe
Install smooth-lined corrugated HDPE pipe according to ASTM D 2321. Use fitting and couplings that comply with the joint performance criteria of AASHTO Standard Specifications for Highway Bridges, Division II. Ensure that all joints are "silt tight" as stated in the AASHTO bridge specifications.
 5. Specials (Wyes, Tees, and Bends)
Install wyes, tees, and bends as shown on the Plans or as directed.
 6. Tapered Pipe Inlets
Locate and install tapered pipe inlet end sections as shown on the Plans or as directed.
 7. Elongation
Elongate metal pipe as shown on the Plans. Order the elongation of the vertical axis of the pipe to be done in the shop.
Have the manufacturer ship metal pipe with wire ties in the pipe ends. Remove wire-ties immediately after completing the fill.
 8. Flared End Sections
Use flared end sections on the inlet, outlet, or on both ends of storm drain pipe, according to Plan details.
 9. PVC Drain Pipe
Install PVC drain pipe according to ASTM D 2321. Use fittings and couplings that comply with the joint performance criteria of AASHTO Standard Specifications for Highway Bridges, Division II. Ensure that all joints are "silt tight" as stated in the AASHTO bridge specifications.

550.3.06 Quality Acceptance

Clean pipe before final acceptance of the Work.

The Department may conduct video surveillance on storm drain (cross drain and longitudinal drain) installations after all activities are complete that may damage the pipe, but before the placement of the base and paving when applicable. If video surveillance shows problems such as pipe deformation, cracking, or joint separation, the Contractor shall repair or replace these pipes at no cost to the Department.

Use a nine-point mandrel to test 100% of the installed length of smooth-lined corrugated HDPE or PVC drain pipe for deformation. Use a mandrel that has an effective diameter equal to 95% of the base inside diameter. Provide the Engineer with a proving ring to verify the mandrel size. Mandrel testing shall not be paid for separately.

Ensure that smooth-lined corrugated HDPE or PVC drain pipe installations have a maximum of 5% deflection when checked after completing all construction activities that may damage the pipe, but before placing the base and paving when applicable. Remove and replace pipe with over 5% deflection at no cost to the Department.

550.3.07 Contractor Warranty and Maintenance

General Provisions 101 through 150.

550.4 Measurement

No measurement to be included for this item.

- A. **Excavation and Backfill** – not measured separately.
- B. **Flat Bottom and Circular Pipe (All Types)** – not measured separately.
- C. **Pipe-Arches** – not measured separately.
- D. **Multiple Installations**– not measured separately.
- E. **Tapered Pipe Inlets** – not measured separately.
- F. **Flared-End Sections** – not measured separately.
- G. **Smooth-Flow Pipe** – not measured separately.
- H. **Elliptical Pipe** – not measured separately.

550.4.01 Limits

Excavation and normal backfill are not measured for payment.

550.5 Payment

Payment will be made under CONSTRUCTION COMPLETE. Includes backfill, pipe installations, excavating, furnishing, and hauling materials; installing, cutting pipe where necessary; repairing or replacing damaged sections; making necessary connections; strutting, elongating, providing temporary drainage; joining an extension to an existing structure where required; and removing, disposing of, or using excavated material as directed by the Engineer.

1. Smooth Flow Pipe

Payment will be made under CONSTRUCTION COMPLETE. Includes furnishing labor, materials, tools, O-ring mechanical joints, equipment, and incidentals to complete this Item, including removing and disposing excavation material.

2. Flared-End Sections

Payment will be made under CONSTRUCTION COMPLETE.

Payment will also include sawing, removing, and replacing existing pavement removed to install a new drainage structure.

**DEPARTMENT OF TRANSPORTATION
STATE OF GEORGIA**

SPECIAL PROVISION

Project Number: CSNHS-0008-00(415)

P.I. Number: 0008415

Fulton County

Add the following:

Section 620—Temporary Barrier

620.1 General Description

This work provides for Method 1 and Method 2 temporary barrier systems.

620.1.01 Definitions

Method 1- Method of furnishing, placing, maintaining, moving, and reusing where required, and removing temporary barrier of the length and at the locations shown on the Plans. Method 1 barrier is not suitable on bridges where the distance from the centerline of the barrier to the free edge of the bridge deck is less than or equal to 6'-0" (1.8 m) measured normal to the barrier.

Method 2- Method of furnishing, placing, maintaining, moving, and reusing where required, and removing manufactured barrier of the length, and at the locations shown on the Plans. Method 2 barrier is to be used on bridges and bridge approaches where the distance from the centerline of the barrier to the free edge of the bridge deck is less than or equal to 6'-0" (1.8 m) measured normal to the barrier.

620.1.02 Related References

A. Standard Specifications

[Section 500—Concrete Structures](#)

[Section 501—Steel Structures](#)

[Section 511—Reinforcement Steel](#)

B. Referenced Documents

General Provisions 101 through 150

National Cooperative Highway Research Program (NCHRP) Report 350.

620.1.03 Submittals

Method 1 - Submit certification from the manufacturer that the proposed barrier and its interconnecting hardware replicates an NCHRP-350 "Test Level 3" approved documented in an acceptance letter from FHWA or certification that the barrier meets the requirements of Ga. Std. 4961. Submit all certification documents to the engineer prior to delivery of the barrier to the project.

Method 2 - Submit certification from the manufacturer that the proposed barrier and its interconnecting hardware replicates an NCHRP 350 "Test Level 3" approved documented in an acceptance letter from FHWA and that the barrier does not deflect more than 1'-0" (300mm) under NCHRP test conditions. Attach the acceptance letter stating that the proposed is in compliance with NCHRP 350 "Test Level 3" and that the barrier meets the deflection criteria to the certification. Submit all certification documents to the engineer prior to delivery of the barrier to the project.

620.2 Materials

A. Method 1

Supply a temporary barrier.

Ensure that materials are in accordance with the manufacturer's recommendations, specifications, and details or that the materials meet the requirements of the Standard Specifications and Ga. Std. 4961.

B. Method 2

Supply a temporary barrier.

Ensure that materials used in the barrier are in accordance with the manufacture's recommendations, Specifications, and details.

620.2.01 Delivery, Storage, and Handling

A. General

Deliver, store, and handle barrier in accordance with the manufacturer's recommendations.

Repair damage to the barrier and its connections in accordance with the manufacturer's recommendations at no additional cost to the Department prior to acceptance for use by the Department.

620.3 Construction Requirements

620.3.01 Personnel

General Provisions 101 through 150.

620.3.02 Equipment

General Provisions 101 through 150.

620.3.03 Preparation

General Provisions 101 through 150

620.3.04 Fabrication

A. Method 1

Perform barrier fabrication as detailed on Ga. Std. 4961 or in accordance with the manufacturer's recommendations.

B. Method 2

Perform barrier fabrication in accordance with the manufacturer's recommendations.

620.3.05 Construction

A. General

Handle and transport units to prevent damage and/or as recommended by the manufacturer. When required, use units at one or more sites on the same project.

Ensure that the units are complete and in acceptable condition and located where designated on the Plans or directed by the Engineer before acceptance by the Department.

Use the Plan quantity of barrier effectively to complete The Work within the Contract time. If scheduling The Work requires additional barrier, furnish it at no additional expense to the Department.

Use only one section shape, length, and connection type in a single run of interconnected barrier.

B. Method 2

Rigidly attach the barrier to the bridge deck and extend it off the bridge a transition distance indicated in the Standard Plans.

Interconnect all barrier sections within each single run of barrier.

Use non-shrink grout to fill all holes remaining in permanent bridge decks after barrier is removed.

620.3.06 Quality Assurance

General Provisions 101 through 150.

620.3.07 Contractor Warranty and Maintenance

General Provisions 101 through 150.

620.4 Measurement

No measurement to be included for this item.

620.4.01 Limits

General Provisions 101 through 150.

620.5 Payment

Payment will be made under CONSTRUCTION COMPLETE. Includes fabrication, use, moving, reuse, and removal of the units.

No separate payment will be made for moving and/or reusing units during the work or for using additional units beyond the Plan quantity to facilitate the construction schedule.

No separate payment will be made for filling holes used to bolt Method 2 barrier to bridge decks.

620.5.01 Adjustments

General Provisions 101 through 150.

**DEPARTMENT OF TRANSPORTATION
STATE OF GEORGIA**

Special Provision

Project Number: CSNHS-0008-00(415)

P.I. Number: 0008415

Fulton County

Section 636—Highway Signs

Delete Subsection 636.3.05.E and substitute the following:

E. Legends and Borders

Place legends and borders according to [Subsection 917.2.01, “Demountable Characters”](#), with Type IX reflective sheeting.

Delete Subsection 636.4 and substitute the following:

636.4 Measurement

No separate measurement will be included for this item.

A. Type-1 or Type-2 Highway Signs

Type 1 or Type 2 highway signs with reflective sheeting of Type III, IV, or IX includes providing the message and furnishing and placing signs complete and accepted.

B. Extruded Aluminum Panels

Includes legend components, border material, fittings, nuts, washers, clamps, molding, etc., furnished, erected, completed, and accepted.

C. Galvanized Steel Posts

Includes number of pounds (kilograms) furnished, erected, and accepted as well as base plates, connections, anchors, stub post, etc.

D. Delineators

Includes posts, rivets, and spacers, that are furnished, placed, and completed and accepted.

E. Mast Arm Assemblies

Includes actual number furnished and erected and concrete footing, sign, and post, completed and accepted.

F. Special Roadside Signs

No deductions are made for the volume of concrete displaced by steel piling, anchor bolts, or posts.

G. Portland Cement

Portland cement stabilized material used for backfilling holes is not measured for payment.

H. Steel H—Piling

No separate measurement will be included for this item.

636.4.01 Limits

General Provisions 101 through 150.

Delete Subsection 636.5 and substitute the following:

636.5 Payment

Payment will be made under CONSTRUCTION COMPLETE.

Office of Materials and Research

**DEPARTMENT OF TRANSPORTATION
STATE OF GEORGIA**

SPECIAL PROVISION

**Project Number: CSNHS-0008-00(415)
P.I. Number: 0008415
Fulton County**

Section 647—Traffic Signal Installation

Delete Subsection 647.3.07.A and substitute the following:

647.3.07 Contractor Warranty and Maintenance

A. Traffic Signal Equipment Maintenance

Perform an inspection with the Engineer to determine the operational status of existing field equipment and finalize materials and equipment that is to be removed due to the project.

Prepare written report identifying what equipment was operational and non-operational and responsibility for repair.

Functional responsibility for new traffic signal equipment installed will become the responsibility of the Contractor until acceptance of the project. Contractor responsibility for operation, maintenance and response to reports of operational or equipment malfunction for existing or newly installed signal material at the intersection begins from the issuance of the Notice to Proceed (NTP) until Final Acceptance of the project.

Measure and document existing vertical signal head clearance during the inspection. Maintain existing vertical clearances until Final Acceptance.

Failure to measure and document vertical clearances as part of the inspection will require that all signals be maintained with a vertical clearance of 17 feet (5.1 m) until Final Acceptance. Maintain newly installed signals continuously as detailed in following sections, until Final Acceptance.

Provide a telephone number where the Worksite Traffic Control Supervisor (WTCS) or responsible representative of the Contractor can be reached twenty four (24) hours a day seven (7) days a week in the event of an emergency.

If a signal is not functioning properly:

1. Non-Emergency

Commence work on this signal within three (3) days of the delivery of written notice or e-mail from the Engineer. Failure to respond within three (3) days will result in liquidated damages in the amount of \$1,000.00 per day, or portion of, until the work is complete.

In addition, the cost of labor and materials will be charged by the Department if the Department takes corrective action after the three (3) days from written notice using its own forces or local municipality forces.

The department or local municipality will not be held responsible or liable for any alleged damage to the signal or as a result of the signal malfunction due to problems that may occur after the Department or local municipality forces make repairs.

2. Emergency

If the Engineer determines that the signal malfunction or failure is an operational hazard, the Contractor is to take corrective action within three (3) hours of the first attempt of verbal notification. Response shall be considered only when *qualified personnel* and equipment are provided.

Failure to respond within three (3) hours will result in a non-refundable deduction of money of \$1,000.00 with an additional charge of \$500.00 per hour after the first three (3) hours until *qualified personnel* and equipment arrives on site and begins corrective action.

In addition, the cost of labor and material will be charged by the Department if the Department takes corrective action after the three (3) hours notification using its own forces or local municipality forces.

Total charges will not exceed \$10,000.00 (per emergency call) in addition to the material cost and labor incurred to make repairs by the Department or local municipality forces respond to the malfunction.

The Department or local municipality will not be held responsible or liable for any alleged damage to the signal or as a result of the signal malfunction due to problems that may occur after Department or local municipality forces make emergency repairs.

The Contractor shall be responsible for all materials and equipment necessary to correct signal malfunction or repair.

Final Acceptance will not be given until payment for such work is received.

First use date: December 16, 2005
Revised : February 24, 2006
May 8, 2007
July 10,2007
September 17,2007
Revised: February 5, 2008

**DEPARTMENT OF TRANSPORTATION
STATE OF GEORGIA**

SPECIAL PROVISION

**Project Number: CSNHS-0008-00(415)
P.I. Number: 0008415
Fulton County**

Section 648-Traffic Impact Attenuator

Delete Section 648 and substitute the following:

648.1 General Description

This work includes furnishing and installing impact attenuator units/arrays to conform with Plan locations and details and/or as directed by the Engineer. All impact attenuator units/arrays shall be tested and approved at the specified NCHRP 350 Test Level.

648.1.01 Definitions

General Provisions 101 through 150.

Gating-A gating end treatment allows a vehicle impacting the nose or the side of the unit at an angle near the nose to pass through the device

Non- Gating-A non-gating end treatment is capable of redirecting a vehicle impacting the nose or the side of the unit along the unit's entire length.

648.1.02 Related References

A. Standard Specifications

General Provisions 101 through 150

B. Referenced Documents

National Cooperative Highway Research Program (NCHRP) Report 350.

ASTM A 123/A 123M

QPL 64

Roadside Design Guide

648.1.03 Submittals

A. Installation Drawings

Submit all required certifications, test reports and drawings of details for completing the installation. Obtain Engineer's approval of these documents before beginning work on attenuator installation. Portable Impact Attenuator arrays shall meet the requirements of Ga. Std. 4960 and manufacturer specifications.

B. Manufacturer's Information

Submit certification from the manufacturer that the attenuator unit/array and its interconnecting hardware replicates an NCHRP-350 approved attenuator in an accepted letter from the FHWA. Furnish items such as manufacturer's brochures or specifications that completely outline the manufacturer's recommendations for materials and installation methods. All workmanship and materials are subject to the Engineer's approval.

648.2 Materials

A. Attenuator

1. Ensure that materials are in accordance with the manufacturer's recommendations, specifications and details.
2. Use attenuators that have been classified as "accepted" by the Department's Office of Materials and Research and approved by the Federal Highway Administration (FHWA) as meeting NCHRP-350 for the test level specified.
3. Where restoration and/or repair cannot be accomplished without the necessity of removing the unit/array from the original location, ensure replacement unit/array installation upon removal of the damaged unit/array. Furnishing, installing and maintaining the replacement will be at no additional cost.
4. Where required, ensure the approach end of the attenuator is equipped with a reflectorized object marker in accordance with Plan Details. The object marker may be furnished by the manufacturer of the attenuator or by others. Ensure that the front most section of the unit (the "nose") is yellow in color unless specified otherwise.
5. Where required, use an approved back-up system as specified in the Plans.
6. For non-gating attenuators, anchor the attenuator to the pavement according to a system recommended by the manufacturer for the type pavement encountered.
7. Use Class "A" concrete for reinforced concrete pads, concrete back up if used, and concrete transition where required.
8. Use metal components and hardware galvanized according to ASTM A 123/A 123M unless otherwise specified. Ensure all metal components and hardware of permanent attenuators are free of corrosion when shipped.
9. In freezing conditions, water filled attenuators shall be treated according to the manufacturer's recommendations.

648.2.01 Delivery, Storage, and Handling

A. General

General Provisions 101 through 150.

648.3 Construction Requirements

648.3.01 Personnel

General Provisions 101 through 150.

648.3.02 Equipment

General Provisions 101 through 150.

648.3.03 Preparation

General Provisions 101 through 150.

648.3.04 Fabrication

A. Design Criteria and Type Selection

The Impact Attenuator Unit/array Type will be shown on the plans and designated by four characters.

- First character

Indicates the type of permanent installation.

The letter "P" designates a permanent (non-gating) installation.

The letter "S" designates a permanent self restoring (non-gating) installation which is capable of withstanding multiple hits without requiring repair or adjustment.

- Second character

Designates the required NCHRP test level.

- Third character
Indicates the traffic flow direction(s).
The letter "B" indicates bi-directional traffic typical for median applications or when the unit is installed on the shoulder of a two-lane, two-way traffic facility. Bi-directional means traffic flows in opposite directions at the site of the attenuator installation.
The letter "U" indicates uni-directional traffic flow typical for gore areas. Uni-directional means traffic on both sides traveling the same direction, from the nose to the rear of the unit.
The letter "S" indicates traffic flow in one direction on a single side only, typical for a unit located on the outside shoulder of a roadway with one-way traffic and the other side of the attenuator not being exposed to traffic.
- Fourth character
Indicates the numerical value of the width, in inches (millimeters), of the base of the rigid object that the attenuator will be shielding.
At bridge columns, this character is typically the width of the column plus the barrier base widths on the column sides at the pavement surface.

B. Example

- A Type P-3-U-60 attenuator designates
 - a permanent installation
 - tested and approved at NCHRP test level 3
 - Uni-directional traffic flow
 - a 60" (1500 mm) wide base for the rigid object being shielded.

Temporary portable units/arrays may be either gating or non-gating based on construction sequencing and/or field conditions, See Specification Section 150. Unless otherwise specified, all permanent attenuators shall be non-gating.

648.3.05 Construction

Field locate the position of the attenuator nose as shown on the plans prior to beginning the installation. Have any variations approved by the Engineer.

If the length of the attenuator unit/array is less than that indicated in the plan details for the specified conditions, the length of the concrete transition section or the length of the longitudinal barrier shall be increased as needed to provide a proper beginning point for the attenuator nose as shown in the plans.

The length of the system will be the combined length of the attenuator unit/array, the back-up system and any required transition. The length of the system shall not be excessive to the extent that it intrudes appreciably within the clear offset distance as shown on the plans.

The increased length of transition or barrier is considered as an incidental part of the system and will not be itemized separately.

Temporary portable units/arrays shall be installed, moved, reinstalled and maintained as required.

648.3.06 Quality Assurance

Obtain certification from the manufacturer that the impact attenuator unit/array installed meets all required approvals and specifications and furnish these to the Engineer.

Furnish any mill test/galvanizing test reports and heat numbers for all metal components of the unit per current requirements of the Department's Office of Materials and Research.

648.3.07 Contractor Warranty and Maintenance

General Provisions 101 through 150.

648.4 Measurement

No measurement to be included for this item. Includes components, hardware, anchors, incidentals, freeze treated water or sand, and labor for each installation shown on the plans or as directed by the Engineer.

648.4.01 Limits

General Provisions 101 through 150.

648.5 Payment

Payment will be made under CONSTRUCTION COMPLETE. Includes materials, labor, and incidentals necessary to complete the Item including installing, moving, reinstalling and maintaining Units/Arrays as required and the back-up system and transitions where required.

648.5.01 Adjustments

General Provisions 101 through 150.

February 15, 1999
Revised September 2, 2002
Revised July 21, 2003
Revised January 8, 2004
Revised April 9, 2004
Revised: February 5, 2008

**DEPARTMENT OF TRANSPORTATION
STATE OF GEORGIA**

SPECIAL PROVISION

**Project Number: CSNHS-0008-00(415)
P.I. Number: 0008415
Fulton County**

Section 652—Painting Traffic Stripe

Retain Section 652 and add the following:

Section 652—Polyurea Traffic Stripe

652.1 General Description

This work includes furnishing and applying reflectorized traffic line paint according to the Plans and these Specifications.

This Item also includes applying words and symbols according to Plan details, Specifications, and the current Manual on Uniform Traffic Control Devices.

652.1.01 Definitions

Painted Stripes: Solid or broken (skip) lines. The location and color are designated on the Plans.

Skip Traffic Stripes: Painted segments between unpainted gaps on a designated sequence with a ratio of 1:3 [10 ft (3 m) segment and 30 ft (9 m) gap] as specified on the Plans. The location and color are designated on the Plans.

652.1.02 Related References

A. Standard Specifications

General Provisions 101 through 150.

[Section 656—Removal of Pavement Markings](#)

[Section 870—Paint](#)

B. Referenced Documents

[QPL 46](#)

AASHTO M 247

ACI Method 503

ASTM C 4060

- ASTM D 711
- ASTM D 1155
- ASTM D 1213
- ASTM D 4061
- ASTM D 6359
- ASTM E 303
- ASTM E 1710
- ASTM G 154
- Federal Standard No. 595A-17778

652.2 Materials

A. Polyurea Composition Requirements

- Use a polyurea composition that is specifically formulated for use as a durable pavement marking material and for application at elevated temperatures not exceeding 170 °F (77 °C).
- Ensure the liquid markings consist of a two-component (Part A and Part B), 100% solids polyurea film formulated and designed to provide a simple volumetric mixing ratio as recommended by the manufacturer.
- Use white or yellow films for the markings. Ensure that these films are manufactured without the use of lead chromate pigments or other similar, lead-containing chemicals.
- Ensure that the white polyurea contains not less than 13% by weight rutile titanium dioxide pigment to insure adequate opacity, hiding power, and reflective properties.

B. Glass Beads and Ceramic Reflective Elements

Use glass beads and/or ceramic reflective elements for the reflective media system that ensures the polyurea pavement markings meet the reflectance performance requirements in Section 652.2.C.2.

C. Finished Product Requirements:

1. Composition

Ensure that the retroreflective pavement markings consist of a mixture of high-quality resins, curing agent and pigments, with a reflective layer bonded to the top surface consisting of glass beads.

2. Reflectance

When applied according to the manufacturer’s recommendations, ensure that the white and yellow markings have the average initial and 12 months retroreflectance values shown in the tables below, as measured in accordance with the testing procedures of ASTM D4061 or ASTM E 1710.

An observation angle of 1.05° and an entrance angle of 88.8° corresponds to 30 meter geometry. The photometric quantity to be measured is the coefficient of retroreflected luminance (R_L) and is expressed as millicandelas per square foot per foot-candle $[(mcd \cdot ft^{-2}) \cdot fc^{-1}]$. The metric equivalent is expressed as millicandelas per square meter per lux $[(mcd \cdot m^{-2}) \cdot lx^{-1}]$.

Determine the initial and 12 months retroreflectance of a single installation according to the measurement and sampling procedures outlined in ASTM D 6359, using a 30-meter retroreflectometer.

Average Minimum Initial Reflectance		
	White	Yellow
Entrance Angle	88.8°	88.8°
Observation Angle	1.05°	1.05°
Retroreflected Luminance $R_L [(mcd \cdot ft^{-2}) \cdot fc^{-1}]$	600	400

Measure initial performance of pavement markings within 7 days after application.

Average Minimum Reflectance at 12 Months		
	White	Yellow
Entrance Angle	88.8°	88.8°
Observation Angle	1.05°	1.05°
Retroreflected Luminance $R_L [(mcd \cdot ft^2) \cdot fc^{-1}]$	400	250

3. Color

Meet these color requirements:

- White markings are pure white and free from dirt or tint.
- Yellow markings are “Federal Yellow” in color.
- The material does not change its color and brightness characteristics after prolonged exposure to sunlight.

4. Skid Resistance

Ensure the surface of the retroreflective marking provides an initial average skid resistance value of 45 BPN when tested according to ASTM E303.

5. Color and Weathering Resistance

Ensure that the mixed polyurea compound, both white and yellow, when applied to 3 in (75 mm) x 6in (150 mm) aluminum panels at 15 ± 1 mils ($0.381 \text{ mm} \pm 0.025 \text{ mm}$) wet thickness without glass beads and exposed in a Q.U.V. Environmental Testing Chamber, as described in ASTM G-53-77, conforms to the following minimum requirements:

- The color of the white polyurea compound is not darker than Federal Standard No. 595A-17778.
- The color of the yellow polyurea compound meets the requirements of the “Federal Yellow” color chart.

6. Drying Time (Laboratory)

When tested in accordance with ASTM D-711 the polyurea marking material shall reach a no-pick-up condition in 10 minutes or less. Perform this test with ASHTO M247 Type 1 beads applied at a rate of 0.099 pounds per square foot (0.483 kg/m^2). Ensure that the drying time does not increase substantially with decreasing temperature.

7. Drying Time (Field)

When installed at 77 °F (25 °C), at a wet film thickness of 20 ± 2 mils ($0.508 \text{ mm} \pm 0.051 \text{ mm}$) and reflectorized with glass beads and/or ceramic reflective elements, ensure that the polyurea markings reaches a no-track condition in less than 10 minutes. Dry to “no-tracking” will be considered as the condition where no visual deposition of the polyurea marking to the pavement surface is observed when viewed from a distance of 50 feet (15 m), after a traveling vehicle’s tires have passed over the marking.

8. Abrasion Resistance

Ensure that the wear index of the polyurea compound does not exceed 0.00026 lbs (120 mg) when tested in accordance with ASTM C4060 using a CS-17 wheel and under a load of 2.2 lbs (1000 g) for 1000 cycles.

9. Adhesion to Concrete

Ensure that the polyurea pavement marking materials, when tested according to ACI Method 503, have such a high degree of adhesion to the specified concrete surface that there is a 100% concrete failure in the performance of this test. Condition the prepared specimens at room temperature $75 \text{ }^\circ \pm 2 \text{ }^\circ\text{F}$ (24 °C) for a minimum of 24 hours and maximum of 72 hours prior to the performance of this test.

10. Adhesion to Asphalt

Ensure that the polyurea pavement marking materials, when tested according to ACI Method 503, have such a high degree of adhesion to the specified asphalt surface that there is a 100% asphalt failure in the performance of this test. Condition the prepared specimens at room temperature $75^{\circ} \pm 2^{\circ}\text{F}$ (24°C) for a minimum of 24 hours and maximum of 72 hours prior to the performance of this test.

652.3 Construction Requirements

652.3.01 Equipment

A. Traveling Traffic Stripe Painter

To apply the traffic marking material, use a mobile, truck mounted and self contained pavement marking machine, specifically designed to apply two-component liquid materials, and glass beads, in a continuous and skip-line pattern.

Apply the two-component liquid materials through airless impingement mixing guns. The guns must accommodate a plural component material system at the manufacturer's recommended volumetric mixing ratio. The guns must have the capacity to deliver materials from approximately 1.5 (5.7 L) to 3 gal (11.4 L) per minute to compensate for a typical range of application speeds of 3 mph (5 km/h) to 6 mph (10 km/h). Ensure that the machine travels at a uniform rate of speed both uphill and downhill.

Select the necessary accessories such as spray tip, mix chamber or static tube, and rod diameter to ensure proper mixing.

Ensure that the machine meets the following:

- The machine is capable of applying three separate stripes, either solid or skip, in any specified pattern by utilizing three adjacent spray nozzles at the same time.
- Each nozzle is equipped with satisfactory cutoff valves that will apply skip lines automatically.
- The application equipment is maneuverable to the extent that straight lines can be followed and normal curves can be made in a true arc.
- The truck-mounted unit is provided with accessories to allow for the marking of symbols and legends.

Ensure that the mobile applicator also includes the following features:

- The mobile applicator provides individual material reservoirs for the storage of Part A and Part B of the resin composition.
- The applicator is equipped with heating equipment of sufficient capacity to maintain the individual resin components at the manufacturer's recommended temperature for spray application.
- The applicator is equipped with separate temperature controls for each component.
- The applicator is equipped with glass bead dispensing equipment and capable of applying the glass beads at a uniform rate.
- The application equipment is equipped with metering devices or pressure gauges on the proportioning pumps as well as stroke counters to monitor volumetric usage. Ensure that the metering devices or pressure gauges and stroke counters are visible.
- The applicator is equipped with all the necessary spray equipment, mixers, compressors, and other appurtenances to allow for the placement of reflectorized pavement markings in a simultaneous sequence of operations.

B. Cleaning Equipment

Use brushes, brooms, scrapers, grinders, high-pressure water jets, or air blasters to remove dirt, dust, grease, oil, and other foreign matter from painting surfaces without damaging the underlying pavement.

652.3.02 Preparation

Before painting, thoroughly clean pavement surfaces of dust, dirt, grease, oil, and all other foreign matter.

Remove concrete curing compounds on new Portland cement concrete surfaces and existing pavement markings on both concrete and asphalt surfaces.

652.3.03 Construction

A. Atmospheric Conditions

Apply pavement markings only during conditions of dry weather and subsequently dry pavement surfaces. Ensure that the pavement surface temperature and the ambient temperature at the time of installation are both greater than 40 °F (4 °C) and that the relative humidity is not greater than 85%.

B. Alignment

Ensure that the traffic stripe is the specified length, width, and placement. On sections where no previously applied markings are present, ensure accurate stripe location by establishing control points at spaced intervals. The Engineer will approve control points.

C. Application

Apply the pavement markings as follows:

1. Apply the liquid marking material by spray method and according to the manufacturer's installation instructions.
2. Ensure marking configurations are in accordance with the "Manual on Uniform Traffic Control Devices."
3. Place the reflectorized pavement markings only on properly prepared surfaces and at the widths and patterns designated on the Plans. Do not begin marking operations until applicable surface preparation work is completed and approved by the Engineer.
4. Air-blast the surface first, to remove any dirt and residues from the pavement. Then apply the pavement markings as a continuous operation.
5. Heat Component A and Component B to the manufacturer's recommended temperatures.
6. Ensure that mixing of the two components occurs in a static tube or impingement chamber prior to reaching the application spray nozzle.
7. Spray the mixed resin onto the pavement surface at a minimum uniform wet thickness of 20 mils (0.51 mm).
8. Immediately following application, drop the glass beads and/or ceramic reflective elements onto the liquid marking at the application rates recommended by the binder manufacture.
9. The work will be subject to application rate checks for both paint and beads.

Following an application of glass beads, and upon curing, ensure that the resulting marking is an adherent reflectorized stripe of the specified thickness and width that is capable of resisting deformation by traffic.

D. Protective Measures

Protect newly applied paint as follows:

1. Traffic
Control and protect traffic with warning and directional signs during painting. Set up warning signs before beginning each operation and place signs well ahead of the painting equipment. When necessary, use a pilot car to protect both the traffic and the painting operation.
2. Fresh Paint
Protect the freshly painted stripe using cones or other satisfactory devices. Repair stripe damage or pavement smudges caused by traffic according to [Subsection 652.3.06](#).

E. Appearance and Tolerance of Variance

Continually deviating from stated dimensions is cause for stopping the work and removing the nonconforming stripe. (See [Section 656](#).) Adhere to the following measurements:

1. Width
Do not lay stripe less than the specified width. Do not lay stripe more than 1/2 in (13 mm) over the specified width.
2. Length
Ensure that the 10 ft (3 m) painted skip stripe and the 30 ft (10 m) gap between painted segments vary no more than ± 1 ft (300 mm) each.

3. Alignment

- a. Ensure that the stripe does not deviate from the intended alignment by more than 1 in (25 mm) on tangents or curves of 1 degree or less.
- b. Ensure that the stripe does not deviate by more than 2 in (50 mm) on curves exceeding 1 degree.

652.3.04 Quality Acceptance

Ensure that stripes and segments of stripes are clean-cut and uniform. Markings that do not appear uniform or satisfactory, either during the day or night, or do not meet Specifications or become marred or damaged by traffic or from other causes, will be corrected at the Contractor's expense.

Sections of painted stripe, words, and symbols placed according to the Plans and Specifications and have dried so that paint will not be picked up or marred by vehicle tires will be accepted. The Contractor will be relieved of responsibility for maintenance on accepted sections.

A. Correction of Alignment

When correcting a deviation that exceeds the permissible tolerance in alignment, do the following:

1. Remove the affected portion of stripe, plus an additional 25 ft (8 m) in each direction.
2. Paint a new stripe according to these Specifications.

Remove the stripe according to [Section 656](#).

B. Removal of Excess Paint

Remove misted, dripped, or spattered paint to the Engineer's satisfaction. Do not damage the underlying pavement during removal.

Refer to the applicable portions of [Section 656](#).

652.4 Measurement

No measurement to be included for this item.

652.5 Payment

Payment will be made under CONSTRUCTION COMPLETE. It includes:

- Cleaning and preparing surfaces
- Furnishing materials, including paints, beads, and thinners
- Applying, curing, and protecting paints
- Protecting traffic, including providing and placing necessary warning signs
- Furnishing tools, machines, and other equipment necessary to complete the Item

**DEPARTMENT OF TRANSPORTATION
STATE OF GEORGIA
SPECIAL PROVISION**

**Project Number: CSNHS-0008-00(415)
P.I. Number: 0008415
Fulton County**

Section 653—Thermoplastic Traffic Stripe

Delete Section 653 and substitute the following:

653.1 General Description

This work includes furnishing and applying thermoplastic reflectorized pavement marking compound. Ensure that markings conform to Plan details and locations, these Specifications, and the Manual on Uniform Traffic Control Devices.

Thermoplastic traffic stripe consists of solid or broken (skip) lines, words, and symbols according to Plan color, type, and location.

653.1.01 Definitions

Thermoplastic Marking Compound: A heated compound extruded or mechanically sprayed on the pavement that cools to pavement temperature. When combined with glass spheres it produces a reflectorized pavement marking.

Short Lines: Crosswalks, stop bars, arrows, symbols, and crosshatching. Extrude short lines rather than spraying them on. Unless otherwise specified, spray all other lines.

653.1.02 Related References

A. Standard Specifications

[Section 652—Painting Traffic Stripe](#)

B. Referenced Documents

[QPL 46](#)

[QPL 71](#)

Federal Test Standard Number 595B

AASHTO M 249

ASTM D 92

ASTM D 476

ASTM D 762

ASTM D 2240

ASTM D 4960

ASTM E 1710

40 CFR 261.24

EPA Method 3050

EPA Method 6010

EPA Method 7000

Federal Test Standard Number 595B

653.1.03 Submittals

Ensure that the producers of the thermoplastic compound and glass spheres furnish to the Department copies of certified test reports showing results of all tests specified in this Section. Also ensure that producers certify that the materials meet the other requirements of this Section by submitting copies of certification at the time of sampling.

653.2 Materials

A. Requirements

Ensure the resin of the thermoplastic material is an alkyd binder. Use alkyd binder consisting of a mixture of synthetic resins and a high boiling point plasticizer. Use at least one synthetic resin that is a solid at room temperature. Ensure at least 50% of the binder composition is 100% maleic-modified glycerol ester resin. Ensure at least 15% by weight of the entire material formulation consists of binder. Do not use alkyd binder that contains petroleum based hydrocarbon resins. Ensure the finished thermoplastic material is not adversely affected by contact with pavement materials or by petroleum droppings from traffic. Use thermoplastic material that has been evaluated (2 year field evaluation) by the National Transportation Product Evaluation Panel (NTPEP) test facility or other approved test facility. Use thermoplastic material produced from an approved source listed on [QPL 46](#). Use thermoplastic material that meets the requirements of AASHTO M 249 with the following exceptions:

1. Color

Confirm the color of thermoplastic as follows:

- a. White – Use titanium dioxide that meets the requirements of ASTM D 476, Type II, Rutile, as the pigment for white thermoplastic material. Do not use anatase titanium dioxide pigment. Use thermoplastic material free from dirt or tint. Ensure white thermoplastic material heated for 240 ± 5 minutes at 425 ± 3 °F (218 ± 3 °C) and cooled to 77 ± 3 °F (25 ± 2 °C) matches Federal Test Standard Number 595B-Color 17925. Use material, when compared to the magnesium oxide standard using a standard color spectrophotometer according to ASTM D 4960, meets the following:

Scale	Definition	Magnesium Oxide Standard	Sample
Rd	Reflectance	100	75 min.
a	Redness-Greenness	0	-5 to + 5
b	Yellowness-Blueness	0	-10 to + 10

- b. Yellow – Use only non-hazardous pigments as defined by the Resource Conservation and Recovery Act (RCRA) Subarticle C rules, table 1 of 40 CFR 261.24 “Toxicity Characteristic”. Do not use yellow thermoplastic containing more than 3.0 ppm lead by weight when tested in accordance with the most up to date EPA Methods 3050 and 6010 or 7000. Ensure yellow thermoplastic material heated for 240 ± 5 minutes at 425 ± 3 °F (218 ± 2 °C) and cooled to 77 ± 3 °F (25 ± 2 °C) matches Federal Test Standard Number 595B-Color 13538. Use material, when compared to PR#1 Chart using a standard color spectrophotometer according to ASTM D 4960, plots within the following chromaticity coordinates:

	1	2	3	4
X	0.455	0.510	0.472	0.530
Y	0.444	0.485	0.400	0.456

Initial Reflectance (CIE Y): 45 minimum

Ensure the in-service daytime chromaticity for yellow material plots within the following coordinates after a period of 30 days:

	1	2	3	4
X	0.435	0.510	0.449	0.530
Y	0.429	0.485	0.377	0.456

2. Indentation Resistance
Measure the hardness by a Shore Durometer, Type A2, as described in ASTM D 2240. Maintain the temperature of the Durometer, 4.4 lb. (2 kg) load and the specimen for 2 hours at 115 °F (45 °C). Apply the Durometer and 4.4 lb. (2 kg) load to the specimen. The reading must fall between 50 to 75 units, after 15 seconds.
3. Reheating
Ensure that the compound does not break down, deteriorate, scorch, or discolor if held at application temperature of 425 °F (218 °C) for 6 hours and if reheated up to 4 times to the application temperature. Ensure that the color of white and yellow thermoplastic comply with [Subsection 653.2.A.1.a](#) and [Subsection 653.2.A.1.b](#) after prolonged heating or reheating.
4. Drop-On Glass Spheres
Use spheres that meet the requirements of [Subsection 652.2](#). Also, use spheres produced from an approved source listed on [QPL-71](#).
5. Sealing Primer
Place the particular type of two-part epoxy binder-sealer at the application rate as recommended in writing by the thermoplastic material manufacturer.
6. Flashpoint
Ensure the thermoplastic flashpoint is not less than 500 °F (260 °C) as determined by ASTM D 92.
7. Specific Gravity
Ensure the specific gravity of the thermoplastic is between 2.00 to 2.20 as determined by ASTM D 762.

B. Performance Requirements

1. General
For a minimum of 30 days from the time of placement, ensure the thermoplastic pavement marking material shows no signs of failure due to blistering, excessive cracking, chipping, bleeding, staining, discoloration, oil content of the pavement materials, smearing or spreading under heat, deterioration due to contact with grease deposits, oil, diesel fuel, or gasoline drippings, spilling, poor adhesion to the pavement material, vehicular damage, and normal wear. In the event that failures mentioned above occur, ensure corrective work is completed at no additional cost to the Department.
2. Retroreflectivity
At the time of installation, ensure the in-place markings when tested according to ASTM E 1710 meet the following minimum reflectance values:

White	375 mcd/lux/m ²
Yellow	250 mcd/lux/m ²

Retest the in-place markings 30 days after installation to ensure these minimum retroreflectance values are maintained.

NOTE: The Contractor is responsible for retroreflectivity testing. Furnish all test reports to the Department.

In the event failures occur, ensure corrective work is completed at no additional cost to the Department. Perform testing according to ASTM E 1710 at above described intervals. Any retest due to failures will be performed at no additional cost to the Department. Furnish all test reports to the Department.

653.2.01 Delivery, Storage, and Handling

Use material delivered in 50 lb (22.7 kg) unit cardboard containers or bags strong enough for normal handling during shipment and on-the-job transportation without loss of material.

Ensure that each unit container is clearly marked to indicate the following:

- Color of the material
- Process batch number or similar manufacturer's identification
- Manufacturer's name
- Address of the plant
- Date of manufacture

653.3 Construction Requirements

653.3.01 Personnel

General Provisions 101 through 150.

653.3.02 Equipment

Depending on the marking required, use hand equipment or truck-mounted application units on roadway installations.

A. Spray Application Machine

Ensure that each spray application machine is equipped with the following features:

- Parts continuously mix and agitate the material.
- Truck-mounted units for lane, edge, and center lines can operate at a minimum of 5 mph (8 kph) while installing striping.
- Conveying parts between the main material reservoir and the shaping die or gun prevent accumulation and clogging.
- Parts that contact the material are easily accessible and exposable for cleaning and maintenance.
- Mixing and conveying parts, including the shaping die or gun, maintain the material at the plastic temperature with heat transfer oil or electrical element controlled heat. Do not use an external source of direct heat.
- Parts provide continuously uniform stripe dimensions.
- Applicator cleanly and squarely cuts off stripe ends and applies skip lines. Do not use pans, aprons, or similar appliances that the die overruns.
- Parts produce varying widths of traffic markings.
- Applicator is mobile and maneuverable enough to follow straight lines and make normal curves in a true arc.

B. Automatic Bead Dispenser

Apply glass spheres to the surface of the completed stripe using a dispenser attached to the striping machine to automatically dispense the beads instantaneously upon the installed line. Synchronize the glass sphere dispenser cutoff with the automatic cutoff of the thermoplastic material.

C. Special Kettles

Use special kettles for melting and heating the thermoplastic material. Kettles equipped with automatic thermostatic control devices provide positive temperature control and prevent overheating. Ensure that the applicator and kettles are equipped and arranged according to the requirements of the National Fire Underwriters.

D. Hand Equipment

Use hand equipment for projects with small quantities of lane lines, edge lines, and center lines, or for conditions that require the equipment. Use hand equipment approved by the Engineer.

Ensure that hand equipment can hold 150 lbs (68 kg) of molten material and is maneuverable to install crosswalks, arrows, legends, lane, edge, and center lines.

E. Auxiliary Vehicles

Supply the necessary auxiliary vehicles for the operation.

653.3.03 Preparation

General Provisions 101 through 150.

653.3.04 Fabrication

General Provisions 101 through 150.

653.3.05 Construction

A. General Application

Thoroughly clean pavement areas to be striped. Use hand brooms, rotary brooms, air blasts, scrapers, or other approved methods that leave the pavement surface clean and undamaged. Take care to remove all vegetation and road film from the striping area. All new Portland Cement Concrete pavement surfaces shall be mechanically wire brushed or abrasive cleaned to remove all laitance and curing compound before being striped.

Lay stripe with continuous uniform dimensions.

Apply the type of stripe at each location according to the Plans, using one of the following methods:

- Spray techniques
- Extrusion methods wherein one side of the shaping die is the pavement, and the other three sides are contained by or are part of the suitable equipment to heat and control the flow of material.

1. Temperature

Apply thermoplastic traffic stripe only when the pavement temperature in the shade is above 40 °F (4 °C).

To ensure optimum adhesion, install the thermoplastic material in a melted state at the manufacturer's recommended temperature but not at less than 375 °F (190 °C).

2. Moisture

Do not apply when the surface is moist. When directed by the Engineer, perform a moisture test on the Portland cement concrete pavement surface. Perform the test as follows:

- a. Place approximately 1 yd² (1m²) of roofing felt on the pavement surface.
- b. Pour approximately 1/2 gallon (2 L) of molten thermoplastic onto the roofing felt.
- c. After 2 minutes, lift the roofing felt and inspect to see if moisture is present on the pavement surface or underside of the roofing felt.
- d. If moisture is present, do not proceed with the striping operation until the surface has dried sufficiently to be moisture free.

3. Binder-Sealer

To ensure optimum adhesion, apply a binder-sealer material before installing the thermoplastic in each of the following cases:

- Extruded thermoplastic
- Where directed by the Engineer for sprayed thermoplastic
- Old asphaltic concrete pavements with exposed aggregates
- Portland cement concrete pavements as directed by the Engineer

Ensure that the binder-sealer material forms a continuous film that mechanically adheres to the pavement and dries rapidly. Use a binder-sealer currently in use and recommended by the thermoplastic material manufacturer according to [QPL 46](#).

To ensure optimum adhesion, apply a two-part epoxy binder-sealer on all Portland cement concrete pavements for either sprayed or extruded thermoplastic material.

Apply the epoxy binder-sealer immediately in advance of, but concurrent with, the application of the thermoplastic material. Apply in a continuous film over the pavement surface.

4. Bonding to Old Stripe

The old stripe may be renewed by overlaying with new material. Ensure the new material bonds to the old line without splitting or cracking.

5. Offset from Construction Joints

Off-set longitudinal lines at least 2 in (50 mm) from construction joints of Portland cement concrete pavements.

6. Crosswalks, Stop Bars, and Symbols

Make crosswalks, stop bars, and symbols at least 3/32 in (2.4 mm) thick at the edges and no more than 3/16 in (4.8 mm) thick at the center.

7. Film Thickness

- a. Maintain the following minimum average film thicknesses on all open graded asphalt concrete friction courses:
 - 0.120 in (3.0 mm)* for lane lines
 - 0.090 in (2.3 mm)* for edge lines
 - 0.150 in (3.8 mm)* for gore area lines
- b. Maintain the following minimum average film thicknesses on all other pavement types:
 - 0.090 in (2.3 mm)* for lane lines
 - 0.060 in (1.5 mm)* for edge lines
 - 0.120 in (3.0 mm)* for gore area lines

(See below for ‘*’ reference.)

Compute the minimums by the amount of material used each day, as follows:

(For 5 in wide stripe)	
* Average Film Thickness (in) =	$[(\text{lbs used}) \div (\text{total linear feet})] \times 0.236$
(For 125 mm wide stripe)	
*Average Film Thickness (mm) =	$[(\text{kg used}) \div (\text{total linear meters})] \times 4.0$
(For 10 in wide stripe)	
* Average Film Thickness (in) =	$[(\text{lbs used}) \div (\text{total linear feet})] \times 0.118$
(For 250 mm wide stripe)	
* Average Film Thickness (mm) =	$[(\text{kg used}) \div (\text{total linear meters})] \times 2.0$

8. Glass Spheres

- a. Apply glass spheres to installed stripe surface at a minimum rate of 14 lbs of spheres to each 100 square feet ((700 g/m²) of thermoplastic material.
- b. Apply the glass sphere top-coating with a pressure-type gun specifically designed for applying glass spheres that will embed at least one-half of the sphere’s diameter into the thermoplastic immediately after the material has been applied to the pavement.

B. Removing Existing Stripe

Remove existing stripe according to [Section 656](#).

Remove 100 percent of existing traffic stripe from:

- Portland cement concrete pavement where the new stripe will be placed at the same location as the existing marking
- Pavement where the new stripe will be placed at a different location from the existing markings

C. Tolerance and Appearance

No traffic stripe shall be less than the specified width and shall not exceed the specified width by more than 1/2 in (13mm). The length of the 10 ft (3 m) segment for skip stripe and the 30 ft (9 m) gap between segments may vary plus or minus 1 ft (300 mm). The alignment of the stripe shall not deviate from the intended alignment by more than 1 in (25 mm) on tangents and on curves up to and including 1 degree (radius of 1745 m or greater). On curves exceeding 1 degree (radius less than 1745 m), the alignment of the stripe shall not deviate from the intended alignment by more than 2 in (50 mm).

Stop work when deviation exceeds the above dimensions, and remove the nonconforming stripe.

653.3.06 Quality Acceptance

Segments of the thermoplastic traffic stripe placed according to the Plans and Specifications may be accepted 30 days after the required work is complete in that segment.

If thermoplastic traffic stripe fails to meet Plan details or Specifications or deviates from stated dimensions, correct it at no additional cost to the Department. If removal of pavement markings is necessary, perform it according to Section 656 and place it according to this Specification. No additional payment will be made for removal and replacement of unsatisfactory striping.

653.4 Measurement

No separate measurement will be included for this item.

653.4.01 Limits

General Provisions 101 through 150.

653.5 Payment

Payment will be made under CONSTRUCTION COMPLETE. Includes:

- Cleaning and preparing surfaces
- Furnishing all materials
- Applying, curing, and protecting stripe
- Protecting traffic, including providing necessary warning signs
- Furnishing tools, machines, and other equipment necessary to complete the Item

653.5.01 Adjustments

General Provisions 101 through 150.

Office of Materials and Research

GEORGIA DEPARTMENT OF TRANSPORTATION
STATE OF GEORGIA
SPECIAL PROVISION

Project Number: CSNHS-0008-00(415)
P.I. Number: 0008415
Fulton County

Section 657— Preformed Plastic Pavement Markings

Delete Subsection 657.1 and Substitute the following:

657.1 General Description

This work includes placing plastic pavement markings or legends according to the Plans and Specifications or as otherwise directed.

657.1.01 Definitions

General Provisions 101 through 150.

657.1.02 Related References

A. Standard Specifications

General Provisions 101 through 150.

B. Referenced Documents

ASTM D 638

ASTM D 4061

ASTM E 303

ASTM E 1710

Manual on Uniform Traffic Control Devices for Streets and Highways

[QPL 74](#)

657.1.03 Submittals

Transfer to the Department manufacturer warranties or guarantees for heat-applied and wet reflective preformed plastic marking materials. Ensure that warranties or guarantees state that they are subject to transfer.

Delete Subsection 657.2 and Substitute with the following:

657.2 Materials

Select one of the following types of preformed marking material according to the Plans and Proposal:

- Type TR – Temporary Removable Plastic Marking

- Type TN – Temporary Non-Removable Plastic Marking
- Type PA – Permanent Plastic Marking
- Type PB – Permanent Patterned Plastic Marking
- Type PW – Permanent Wet Reflective Plastic Marking

For a list of sources, see [QPL-74](#).

A. General Requirements for Preformed Pavement Markings

1. Shapes and Sizes

Use markings that conform to the shapes and sizes outlined in the Manual on Uniform Traffic Control Devices for Streets and Highways.

2. Pigmentation

Use white or yellow pigmented plastic according to each marking type.

3. Adhesion

Use markings that can be affixed to bituminous or Portland cement concrete pavements by pressure-sensitive pre-coated adhesive or a liquid contact cement.

Ensure that marking adhesive adheres to the roadway under normal climactic and traffic conditions.

4. Conformability

Use markings that will mold to pavement contours, breaks, faults, and the like, by normal action of traffic at normal pavement temperatures.

5. Resealability

Use markings containing resealing characteristics that allow the material to fuse to itself or to similar previously applied material under normal use.

6. Glass or Ceramic Beads

Use markings with a layer of glass or ceramic beads bonded to the surface according to the marking type. Type PB contains ceramic beads and glass beads. Types TR, TN, and PA contain only glass beads.

Use glass beads with less than 2% by weight showing any milkiness, scoring or scratching. Use clear, transparent beads that are free from air inclusions and conform to the following:

	Glass Beads	Ceramic Beads
Refractive Index, (tested by oil immersion)	1.50 minimum	1.70 minimum
Uniform Distribution of Spheres	0.75 minimum	0.75 minimum

7. Reflective Intensity

Determine reflective intensity using photometric testing procedures of Federal Specification L-S-300 A, Paragraph 4.4.7.

Ensure that marking types TR, TN, and PA use white or yellow film with the initial reflective intensity indicated in the table below, when measured at the angles shown. See [Subsection 657.2.C.2.k](#) for reflective intensity of Type PB.

	White		Yellow	
	0.2°	0.5°	0.2°	0.5°
Divergence Angle				
Incidence Angle	86°		86°	
Reflective Intensity --candle power per foot-candle per square foot (Candelas per Lux per square meter)	1.00	0.75	0.75	0.50

8. Composition

Use markings made of high-quality polymeric materials and pigments. Ensure types TR, PA, and PB contain the following composition of materials:

Material	Min% By Weight
Resins and Plasticizers	20
Pigments	30
Graded Glass Beads	33

B. Requirements for Temporary Markings (Types TR and TN)

1. Temporary Removable Markings (Type TR)

Use temporary, removable markings that meet the following requirements:

a. Removability

Ensure the marking material can be removed from asphaltic and Portland cement as follows:

- Lifted intact or in large pieces.
- Lifted either manually or with a roll-up device.
- Lifted at temperatures above 40 °F (5 °C) without using heat, solvents, sand blasting, or grinding.

Ensure the pavement shows no objectionable staining or damage after removing the marking.

b. Elongation and Tensile Strength

Provide temporary markings with the following elongation and tensile strength when tested according to ASTM D 638:

Elongation	0.75 minimum
Tensile Strength	40 lbs/in ² (275 kPa) minimum

Test as follows:

- 1) Cut a 1 in by 6 in (25 mm by 150 mm) specimen.
- 2) Test at a temperature between 70 °F and 80 °F (21 °C and 27 °C).
- 3) Test at a jaw speed of 12 in/min (300 m/min).

c. Adhesion

Ensure that at least 10 lbs (20 N) of force is required to lift stuck-on marking material from the pavement.

d. Glass Bead Retention

Confirm the glass bead retention quality of marking material in both of the following ways:

1) Laboratory Test

- Take a 2 in by 6 in (50 mm by 150 mm) sample.
- Bend the sample over a ½ in (13 mm) diameter mandrel, leaving the 2 in (50 mm) side perpendicular to the mandrel axis.
- Ensure that the area on the mandrel shows no more than 10 percent of the beads entrapped by the binder less than 40 percent.

2) Field test

Ensure the beads cannot be easily removed by scratching the material firmly with the thumbnail.

e. Skid Resistance

Ensure that the material surface provides a 35 BPN minimum skid resistance value when tested according to ASTM E 303.

f. Thickness

Ensure that the removable marking material is at least 20 mils (0.50 mm) thick not including the backing adhesive.

2. Temporary Non-Removable markings (Type TN)

This type of pavement marking may use a conformable metallic foil backing with a precoated pressure-sensitive adhesive.

a. Abrasion Resistance

Use marking material that does not wear through to the backing surface in less than 125 cycles.
Test according to Federal Test Standard 141, Method 6192, using an H-22 wheel and a 250 gram load.

b. Skid Resistance

Ensure the retroreflective pliant polymer surface provides a skid resistance value of at least 35 BPN. Test according to ASTM E 303.

c. Elongation and Tensile Strength

No test for elongation and tensile strength is required for type TN marking.

d. Glass Bead Retention

Refer to [Subsection 657.2.B.1.d, "Glass Bead Retention"](#) for types TR and TN.

e. Thickness

Ensure the nonremovable marking material is at least 20 mils (0.50 mm) not including the adhesive backing.

C. Requirements for Permanent Markings (Types PA, PB and PW)

1. Permanent Plastic Marking (Type PA)

Provide permanent plastic markings with these features:

a. Adhesive and Backing

Use markings supplied with the following:

- A precoated adhesive
- An easily removable backing to protect the adhesive
- An adhesive backing that allows repositioning of the marking on the surface before permanently sticking with greater pressure

In addition, supply rolls of lane lines with a precoated adhesive but without the protective backing material.

b. Pigments

1) White

Use white marking material with at least 20 percent of the total pigment consisting of titanium dioxide that meets Federal Specification TT-P442 for a dense opaque marking.

2) Yellow

Use yellow marking material with sufficient yellow pigment for a durable finished color.

In addition, match the yellow to the Highway Yellow Color Tolerance Chart and Chip 33538 of Federal Standard 595.

3) Appearance

Ensure that each marking meets the following appearance standards:

- Markings are extruded to a uniform thickness.
- Edges are smoothly cut and true.
- Glass spheres are retained on all sides by the plastic base material.
- The wearing surface is free of indentations, displaced spheres, or other irregularities that retain dirt, dust, or other foreign materials.

c. Thickness

Ensure the permanent material is at least 60 mils (1.52 mm) thick, without the pre-coated adhesive.

d. Glass Bead Retention

Confirm that the surface glass beads are strongly bonded and are not easily removed by traffic. Test them as follows:

- 1) Use a Taber Abraser with an H-18 wheel and 125 gram load.
- 2) Inspect the sample at 200 cycles under the microscope to observe the extent and type of bead failure.
- 3) Ensure that no more than 15 percent of the beads have popped-out.
- 4) Verify that the predominant mode of failure is "wear-down" of the beads.

e. Reseal Test

Test the plastic to confirm that it reseals to itself. Test as follows:

- 1) Cut two samples, 1 in by 3 in (25 mm by 75 mm) each, keeping the adhesive backing material in place.
- 2) Overlap these pieces face-to-face on a flat steel plate. The overlap area should be 1 in² (625 mm²).
- 3) Center a 1000 gram weight over the overlap area.
- 4) Place the sample in an oven for 2 hours at 190 °F ± 10 °F (88 °C ± 5 °C).
- 5) Cool the sample to room temperature.
- 6) Ensure the sample pieces cannot be separated except by tearing. Reject material that separates without tearing.

f. Tensile Strength and Elongation

Ensure that the permanent markings have the following elongation and tensile strength when tested according to ASTM D 638:

Elongation	75% minimum
Tensile Strength	150 psi (1035 kPa) minimum

Test as follows:

NOTE: Run this test 3 times and base the result on an average of the 3 tests.

- 1) Cut 3 specimens, 1 in by 6 in (25 mm by 150 mm) each.
- 2) Place 1 in² (625 mm²) of carborundum extra-coarse emery cloth or its equivalent at each end of the test specimens to prevent the adhesive from sticking to test equipment.
- 3) Test at a temperature between 70 ° and 80 °F (21° and 27 °C).
- 4) Test at a jaw speed of 10 to 12 in/min (250 mm to 300 mm/min).

g. Skid Resistance

Test the plastic surface to verify that it provides a skid resistance value of at least 45 BPN. Test according to ASTM E 303.

h. Abrasion Resistance

Ensure that plastic loses no more than 0.25 grams of weight in 500 revolutions when abraded according to Federal Test Method Standard No. 141 (Method 6192).

Test the material with calibrate H-18 wheels with a 1000 gram load on each wheel.

i. Adhesive Shear Strength

Ensure that the load required to break the adhesive bond is strong enough to resist a load at least 10 lbs (4.54 kg).

Test as follows:

NOTE: Run this test 3 times and base the result on an average of the 3 tests

- 1) Cut 3 specimens, 1 in by 6 in (25 mm by 150 mm) each.
- 2) Apply a 1 in by 3 in (25 mm by 75 mm) piece of carborundum extra coarse emery cloth or its equivalent to the adhesive face of each test strip. Overlap the area by 1 in² (625 mm²).
- 3) Apply 60 psi (415 kPa) of pressure over the overlapped area for 120 seconds.
Apply the load by gripping the ends of each laminated piece in a tensile test machine, such as a Dillon or Scott tester.
- 4) Run the test at 77 °F (25 °C).
- 5) Run the test at 0.25 in/min (64 mm/min).

2. Permanent Patterned Plastic Marking (Type PB)

Use patterned plastic markings with these features:

a. Patterned Surface

Ensure that the patterned surface has the following characteristics:

- A reflective layer of ceramic beads bonded to a durable polyurethane topcoat.
 - The raised area comprises between 35 and 65 percent of the total marking face.
 - The surface presents a near vertical face to traffic from any direction.
 - The Office of Materials and Research approves the pattern configuration.
 - The channels between raised areas are free of exposed beads or particles.
- b. Adhesive and Backing
Refer to [Subsection 657.2.C.1.a, “Adhesive and Backing”](#) for Type PA.
- c. Pigments
Refer to [Subsection 657.2.C.1.b, “Pigments”](#) for Type PA.
- d. Ceramic Beads
Ensure that the top layer of ceramic beads is bonded to a durable polyurethane surface.
- e. Ceramic Bead Retention
Refer to [Subsection 657.2.C.1.d, “Glass Bead Retention”](#) for Type PA.
- f. Thickness
Ensure the materials are at least 60 mils (1.52 mm) thick, not including the pre-coated adhesive backing.
- g. Reseal Test
Refer to [Subsection 657.2.C.1.e, “Reseal Test”](#) for Type PA.
- h. Tensile Strength and Elongation
Refer to [Subsection 657.2.C.1.f, “Tensile Strength and Elongation”](#) for Type PA.
- i. Skid Resistance
Refer to [Subsection 657.2.C.1.g, “Skid Resistance”](#) for Type PA.
- j. Abrasion Resistance
Refer to [Subsection 657.2.C.1.h, “Abrasion Resistance”](#) for Type PA.
- k. Reflective Intensity
Determine reflective intensity using photometric testing procedures of Federal Specification L-S-300 A, Paragraph 4.4.7. Reflective values are as follows:

	White			Yellow		
	0.2°	1.0°	1.05°	0.2°	1.0°	1.05°
Observation Angle	0.2°	1.0°	1.05°	0.2°	1.0°	1.05°
Entrance Angle	86°	86.5°	88.8°	86°	86.5°	88.8°
Reflective Intensity--candle power per foot-candle per 5 ft ² (Candelas per Lux per square meter)	1.10	0.70	0.50	0.80	0.50	0.30

3. Wet Reflective Preformed Pavement Markings (Type PW)

- a. Reflective Intensity
Determine reflective intensity using photometric testing procedures of ASTM D 4061 under dry conditions and ASTM E 1710 under wet conditions.
- Create the wet test condition by pouring clean water from a bucket of approximately 3 gallon (11 Liter) capacity from a height of approximately 20 in (500 mm) above the surface. Pour the water evenly along the test surface so that a crest of water momentarily floods the measuring field and its surrounding area.
- Ensure that markings use white or yellow film with the initial reflective intensity indicated in the table below, when measured at the angles shown.

Divergence Angle	White			Yellow		
	0.2°	1.0°	1.05°	0.2°	0.5°	1.05°

Incidence Angle	86.0°	86.5°	88.8°	86.0°	86.5°	88.8°
Reflective Intensity --candle power per foot-candle per square foot (Candelas per Lux per square meter)	1.50	1.00	0.75	1.10	0.70	0.45

b. Composition

Use markings made of high-quality polymeric materials, pigments and reflective glass beads enclosed in a polymeric layer.

c. Adhesive and Backing

Use markings supplied with the following:

- A precoated adhesive.
- An easily removable backing to protect the adhesive.
- An adhesive backing that allows repositioning of the marking on the surface before permanently sticking with greater pressure.

In addition, supply rolls of lane lines with a precoated adhesive but without the protective backing material.

d. Appearance

Ensure that each marking meets the following appearance standards:

- Markings are extruded to a uniform thickness.
- Edges are smoothly cut and true.
- Glass spheres are retained on all sides by the plastic base material.
- The wearing surface is free of indentations or other irregularities that retain dirt, dust, or other foreign materials.
- The color conforms to standard white or yellow highway colors.

e. Thickness

Ensure the permanent material is at least 30 mils (0.76 mm) thick, without the pre-coated adhesive.

f. Elongation and Tensile Strength

Provide temporary markings with the following elongation and tensile strength when tested according to ASTM D 638:

Elongation	0.75 minimum
Tensile Strength	150 psi (1035 kPa) minimum

Test as follows:

NOTE: Run this test 3 times and base the result on an average of the 3 tests.

- 1). Cut 3 specimens, 1 in by 6 in (25 mm by 150 mm) each.
- 2). Place 1 in² (625 mm²) of carborundum extra-coarse emery cloth or its equivalent at each end of the test specimens to prevent the adhesive from sticking to test equipment.
- 3). Test at a temperature between 70 °F and 80 °F (21 °C and 27 °C).
- 4). Test at a jaw speed of 10 to 12 in/min (250 mm to 300 mm/min).

g. Skid Resistance

Test the plastic surface to verify that it provides a skid resistance value of at least 50 BPN. Test according to ASTM E 303.

h. Plastic Pull Test

- 1). Cut a test specimen to 1 in by 6 in (25 mm by 150 mm).
- 2). Ensure that the specimen can support a dead load weight of 6 lbs (27 N) for at least 30 minutes.
- 3). Test at a temperature between 70 °F and 80 °F (21 °C and 27 °C)

Date: November 1, 2002
First Use Date January 1, 2003
Revised December 30, 2002
Revised August 4, 2003
Revised April 27, 2004
First Use Date June 1, 2004
Revised October 31, 2005
Revised: February 5, 2008

**DEPARTMENT OF TRANSPORTATION
STATE OF GEORGIA**

SPECIAL PROVISION

**Project Number: CSNHS-0008-00(415)
P.I. Number: 0008415
Fulton County**

Section 700—Grassing

Delete Section 700 and substitute the following:

700.1 General Description

This work includes preparing the ground, furnishing, planting, seeding, fertilizing, sodding, and mulching disturbed areas within the Right-of-Way limits and easement areas adjacent to the right-of-way as shown on the Plans except as designated by the Engineer to remain natural.

700.1.01 Definitions

General Provisions 101 through 150.

700.1.02 Related References

A. Standard Specifications

[Section 160—Reclamation of Material Pits and Waste Areas](#)

[Section 163—Miscellaneous Erosion Control Items](#)

[Section 718—Wood Fiber](#)

[Section 822—Emulsified Asphalt](#)

[Section 882—Lime](#)

[Section 890—Seed and Sod](#)

[Section 891—Fertilizers](#)

[Section 893—Miscellaneous Planting Materials](#)

[Section 895—Polyacrylamide](#)

B. Referenced Documents

[QPL 33](#)

[QPL 84](#)

700.1.03 Submittals

Submit manufacturer’s product expiration date along with written instructions to ensure proper application, safety, storage, and handling of Polyacrylamide products used in The Work.

700.2 Materials

Use materials that meet the requirements of the following Specifications:

Material	Section
Wood Fiber Mulch	718.2
Emulsified Asphalt	822
Agricultural Lime	882.2.01
Liquid Lime	882.2.01
Seed	890.2.01
Sod	890.2.02
Fertilizer	891.2.01
Plant Topsoil	893.2.01
Mulch	893.2.02
Inoculants	893.2.04
Tackifiers	QPL 33
Anionic Polyacrylamide	QPL 84 & Section 895

A. Seeds

Whenever seeds are specified by their common names, use the strains indicated by their botanical names.

B. Water

Obtain the water for grassing from an approved source. Use water free of harmful chemicals, acids, alkalies, and other substances that may harm plant growth or emit odors. Do not use salt or brackish water.

C. Asphalt

Secure the mulch with asphalt made of a homogenous emulsification of a refined petroleum. Ensure that the asphalt can be sprayed on with or without diluting with water.

Use suitable asphalt free of petroleum solvents or other diluting agents that may harm plant growth. Use asphalt according to [Section 822](#) or [Section 824](#), “slow setting”. Do not use asphalt that separates after freezing or from any other cause.

D. Fertilizer Mixed Grade

Select fertilizer mixed grade such as 10-10-10, 6-12-12, 5-10-15, or other analysis within the following limits:

- Nitrogen 5 to 10 percent
- Phosphorus 10 to 15 percent
- Potassium 10 to 15 percent

If using mixed grade fertilizer for hydroseeding, ensure that it has the following analysis:

- Nitrogen 5 to 19 percent
- Phosphorus 10 to 19 percent

- Potassium 10 to 19 percent

E. Mulch

Use straw or hay mulch according to [Subsection 700.3.05.G](#).

Use wood fiber mulch in hydroseeding according to [Subsection 700.3.05.F.1](#).

700.2.01 Delivery, Storage, and Handling

General Provisions 101 through 150.

700.3 Construction Requirements

700.3.01 Personnel

General Provisions 101 through 150.

700.3.02 Equipment

Use grassing equipment able to produce the required results.

Never allow the grading (height of cut) to exceed the grassing equipment's operating range.

A. Blower Equipment

When using blower equipment to apply bituminous treated mulch in a single operation, place two or more jets or spray nozzles at or near the end of the discharge spout to eject a uniform coat of mulch.

B. Mulch Material Equipment

Use mulching equipment that uniformly cuts the specified materials into the soil to the required control depth.

C. Rollers

Use at least 12 in (300 mm) diameter rollers with corrugated or notched surfaces. Do not use smooth surface rollers.

D. Hydroseeding Equipment

For hydroseeding equipment, see [Subsection 700.3.05.F](#).

700.3.03 Preparation

General Provisions 101 through 150.

700.3.04 Fabrication

General Provisions 101 through 150.

700.3.05 Construction

Follow the planting zones, planting dates, types of seed, seed mixtures, and application rates described throughout this Section. The Engineer has the authority to alter the planting dates as set forth by a period of 2 weeks. This 2-week period may be applied to either the beginning of the specified planting and/or to the end of the end of the specified planting season.

In general:

- Obtain the Engineer's approval before changing the ground cover type.
- Do not use annual rye grass seeds with permanent grassing.
- Follow the planting zones indicated on the [Georgia State Planting Zone Map](#), below.
- Sod may be installed throughout the year, weather permitting.
- For permanent grassing, apply the combined amounts of all seeds for each time period within each planting zone and roadway location listed in the [Seeding Table](#), below. Do not exceed the amounts of specified seed.

Planting Zone Map



SEEDING TABLE

Plant these combinations on shoulders, medians, and relatively flat areas. (Slopes 3:1 or flatter).		Rye Grass, Millet, Cereal Grass (Oats)	Common Bermuda Grass (Hulled)	Common Bermuda Grass (Unhulled)	Tall Fescue	Weeping Love Grass	Scarified Interstate Lespedeza	Unscarified Interstate Lespedeza	REQUIRED PERMANENT PLANTING
									Planting Zones
1	March 1 – May 15		10 (11)	10 (11)	50 (56)				Common Bermuda Grass
1	May 16 – August 31		10 (11)	10 (11)					
1	September 1 – February 28	50 (56)							
2,3,4	April 1 – October 31		10 (11)	10 (11)					
2,3,4	November 1 – March 31	50 (56)							Common Bermuda Grass

Plant these combinations on back slopes, fill slopes and areas which will not be subject to frequent mowing, slopes steeper than 3:1									
1,2	March 1 – August 31					10 (11)	50 (56)		Interstate Lespedeza
1,2	September 1 – February 28				50 (56)			75 (84)	
3,4	April 1 – October 31					10 (11)	50 (56)		Interstate Lespedeza
3,4	November 1 – March 31	50 (56)							

A. Ground Preparation

Prepare the ground by plowing under any temporary grass areas and preparing the soil as follows:

1. Slopes 3:1 or Flatter

On slopes 3:1 or flatter, plow shoulders and embankment slopes to between 4 in and 6 in (100 mm and 150 mm) deep.

Plow front and back slopes in cuts to no less than 6 in (150 mm) deep. After plowing, thoroughly disk the area until pulverized to the plowed depth.

2. Slopes Steeper Than 3:1

Serrate slopes steeper than 3:1 according to Plan details when required.

On embankment slopes and cut slopes not requiring serration (sufficient as determined by the Engineer), prepare the ground to develop an adequate seed bed using any of the following methods as directed by the Engineer:

- Plow to a depth whatever depth is practicable.
- Use a spiked chain.
- Walk with a cleated track dozer.
- Scarify.

Disking cut slopes and fill slopes is not required.

3. All Slopes

a. Obstructions

Remove boulders, stumps, large roots, large clods, and other objects that interfere with grassing or may slide into the ditch.

b. Topsoil

Spread topsoil stockpiled during grading evenly over cut and fill slopes after preparing the ground.

Push topsoil from the top over serrated slopes. Do not operate equipment on the face of completed serrated cuts.

B. Grassing Adjacent to Existing Lawns

When grassing areas adjacent to residential or commercial lawns, the Engineer shall change the plant material to match the type of grass growing on the adjacent lawn. The Contract Unit Price will not be modified for this substitution.

If the Engineer believes bituminous treated mulch would harm other portions of the work, bituminous treated mulch may be substituted with 1,500 lbs/acre (1680 kg/ha) of wood fiber mulch with tackifier.

C. Temporary Grassing

Apply temporary grassing according to [Subsection 163.3.05.F](#). Determine lime requirements by a laboratory soil test.

In March or April of the year following planting and as soon as the weather is suitable, replace all areas of temporary grass with permanent grass by plowing or overseeding using the no-till method. If the no-till method is used, ensure that temporary grass is less than 3 inches in height (this may be achieved by mowing). Additional mulch will be required only if the temporary grass does not provide adequate mulch to meet the requirements of [Subsection 700.3.05.G](#), “[Mulching.](#)”

Temporary grass, when required, will be paid for according to [Section 163](#).

Projects that consist of asphalt resurfacing with shoulder reconstruction and/or shoulder widening: Type II Wood Fiber Blanket is used to stabilize disturbed areas, no till seeding will be used when permanent grassing is applied and the areas will not be re-disturbed.

D. Applying Agricultural Lime and Fertilizer Mixed Grade

Apply and mix lime and fertilizer as follows:

1. Agricultural Lime

Uniformly spread agricultural lime on the ground at the approximate rate determined by the laboratory soil test.

- A. Liquid Lime (Flowable Dolomitic Lime) may be applied during the hydroseeding operation at the rate of 2.5 gallons (of Liquid Lime concentrate) per acre (23.75 liters per hectare). This provides the equivalent of 1 ton per acre (2.25 mg per hectare) of agricultural lime. The remainder of lime specified by the soil test is applied as agricultural lime and uniformly spread over the surface of the ground.

B. Agricultural Lime may be used as filler material in mixed grade fertilizer in lieu of inert material. The use of agricultural lime as filler material is to be shown on the fertilizer bag or invoice from the supplier. Do not deduct any amount of fertilizer when lime is used as filler.

2. Fertilizer Mixed Grade

Uniformly spread the fertilizer selected according to [Subsection 700.2.D](#) over the ground at approximately 1,200 lbs/acre (1350 kg/ha).

If using a higher analysis fertilizer with hydroseeding, apply it at the same rate per acre (hectare) as the standard fertilizer.

3. Mixing

Before proceeding, uniformly work the lime and fertilizer into the top 4 in (100 mm) of soil using harrows, rotary tillers, or other equipment acceptable to the Engineer.

On cut slopes steeper than 3:1, other than serrated slopes, reduce the mixing depth to the maximum practical depth as determined by the Engineer.

Omit mixing on serrated slopes.

E. Seeding

Following is a list of both common names and botanical names for approved seed types. Whenever seeds are specified by the common names, the strains indicated by their botanical name apply.

Common Name	Botanical Name
Annual Ryegrass	Lolium multiflorum
*Bermuda Grass, Common Hulled and Unhulled	Cynodon dactylon
**Lespedeza Virgata	Lespedeza Ambro Virgata
**Lespedeza Sericea	Lespedeza cuneta, Var. Sericea
**Lespedeza Serala	Lespedeza cuneta, Var. Serala
**Lespedeza Interstate	Lespedeza cuneta, Var. Interstate
**Lespedeza Korean	Lespedeza stipulacea Maxim
Pensacola Bahiagrass	Paspalum notatum, var. Pensacola
Tall Fescue	Festuca arundinacea
Weeping Love Grass	Eragrostis curvula
*Do not use Giant Bermuda Seed (Cynodon species) including NK-37.	
**Requires inoculation.	

Prepare seed and sow as follows:

1. Inoculation of Seed

Inoculate each kind of leguminous seed separately with the appropriate commercial culture according to the manufacturer's instructions for the culture.

When hydroseeding, double the inoculation rate.

Protect inoculated seed from the sun and plant it the same day it is inoculated.

2. Sowing

Weather permitting, sow seed within 24 hours after preparing the seed bed and applying the fertilizer and lime.

Sow seed uniformly at the rates specified in the [Seeding Table](#). Use approved mechanical seed drills, rotary hand seeders, hydraulic equipment, or other equipment to uniformly apply the seed. Do not distribute by hand.

To distribute the seeds evenly sow seed types separately, except for similarly sized and weighted seeds. They may be mixed and sown together.

3. Rolling

Roll seeded areas before applying mulch, except on steep slopes where rollers cannot operate satisfactorily. On slopes inaccessible to compaction equipment, cover the seeds by dragging spiked chains over them or by using other methods.

Do not sow during windy weather, when the prepared surface is crusted, or when the ground is frozen, wet, or otherwise non-tillable.

4. Overseeding

Temporary grass areas that were prepared in accordance with [Subsection 700.3.05.A](#), may be overseeded using the no-till method. The no-till method is defined by planting permanent grass seeds using a drill-type seeder over existing temporary grass without plowing or tilling soil and in accordance with [Subsection 700.3.05.C](#).

F. Hydroseeding

Hydroseeding may be used on any grassing area. Under this method, spread the seed, fertilizer, and wood fiber mulch in the form of a slurry. Seeds of all sizes may be mixed together. Apply hydroseeding as follows:

1. Use wood fiber mulch as a metering agent and seed bed regardless of which mulching method is chosen. Apply wood fiber mulch at approximately 500 lbs/acre (560 kg/ha).
2. Prepare the ground for hydroseeding as for conventional seeding in [Subsection 700.3.05.A](#).
3. Use specially designed equipment to mix and apply the slurry uniformly over the entire seeding area.
4. Agitate the slurry mixture during application.
5. Discharge slurry within one hour after being combined in the hydroseeder. Do not hydroseed when winds prevent an even application.
6. Closely follow the equipment manufacturer's directions unless the Engineer modifies the application methods.
7. Mulch the entire hydroseeded area according to [Subsection 700.3.05.F.1](#), above, and [Subsection 700.3.05.G](#), below.

G. Mulching

Except as noted in [Subsection 700.3.05.B](#) and [Subsection 700.3.05.C](#), apply mulch immediately after seeding areas as follows:

Areas with permanent grass seed and covered with slope mats or blankets will not require mulch.

Evenly apply straw or hay mulch between 3/4 in and 1-1/2 in (20 mm and 40 mm) deep, according to the texture and moisture content of the mulch material.

Mulch shall allow sunlight to penetrate and air to circulate as well as shade the ground, reduce erosion, and conserve soil moisture. If the type of mulch is not specified on the Plans or in the Proposal, use any of the following as specified.

1. Mulch with Binder

Apply mulch with binder regardless of whether using ground or hydroseeding equipment for seeding.

- a. Mulch uniformly applied manually or with special blower equipment designed for the purpose. When using a blower, thoroughly loosen baled material before feeding it into the machine so that it is uniformly coated with binder and broken up.
- b. After distributing the mulch initially, redistribute it to bare or inadequately covered areas in clumps dense enough to prevent new grass from emerging.

Do not apply mulch on windy days.

- c. Apply enough binder to the mulch to hold it in place. Immediately replace mulch that blows away.

When using a power blower to distribute the mulch, spray the binder onto the mulch as the mulch is ejected from the machine. If distributing the mulch by hand, immediately apply the binder uniformly over the mulched areas.

Use one of the following binders:

- Emulsified asphalt, SS-1h or SS-1 ([Section 822](#)) : The public, adjacent property, bridges, pavements, curbs, sidewalks, and other existing structures shall be protected from discoloration by the asphalt. Correct discoloration damage at no expense to the Department.
 - Tackifier: Use a tackifier listed in the Laboratory Qualified Products Manual may be used at the manufacturer's recommended rates.
2. Walked-in-Mulch
- Apply walked-in-mulch on slopes ranging in steepness from 5:1 to 2:1 and treat as follows:
- a. Immediately walk it into the soil with a cleated track dozer. Make dozer passes vertically up and down the slope.
 - b. Where walked-in-mulch is used, do not roll or cover the seeds as specified in [Subsection 700.3.05.E.3](#).

H. Sod

Furnish and install sod in all areas shown on the Plans or designated by the Engineer.

1. Kinds of Sod

Use only Common Bermudagrass (*Cynodon dactylon*) or one of the following Bermudagrass varieties:

Tifway 419
 Tifway II
 Tift 94
 Tifton 10
 Midlawn
 Midiron
 GN-1
 Vamont

No dwarf Bermuda types shall be used. Sod shall be nursery-grown and be accompanied with a Georgia Department of Agriculture Live Plant License Certificate or Stamp. Sod shall consist of live, dense, well-rooted material free of weeds and insects as described by the Georgia Live Plant Act.

2. Type And Size Of Sod:

Furnish either big roll or block sod. Ensure that big roll sod is a minimum of 21 inches wide by 52 feet long. Minimum dimensions for block sod are 12 inches wide by 22 inches long. Ensure all sod consists of a uniform soil thickness of not less than 1 inch.

3. Ground Preparation

Excavate the ground deep enough and prepare it according to [Subsection 700.3.05.A](#) to allow placing of sod. Spread soil, meeting the requirements of [Subsection 893.2.01](#), on prepared area to a depth of 4 inches.

4. Application Of Lime And Fertilizer

Apply lime and fertilizer according to [Subsection 700.3.05.D](#) within 24 hours prior to installing sod.

5. Weather Limitation

Do not place sod on frozen ground or where snow may hinder establishment.

6. Install Sod

Install Sod as follows:

- Place sod by hand or by mechanical means so that joints are tightly abutted with no overlaps or gaps. Use soil to fill cracks between sod pieces, but do not smother the grass.
- Stake sod placed in ditches or slopes steeper than 2:1 or any other areas where sod slipping can occur.
- Use wood stakes that are at least 8 in (200 mm) in length and not more than 1 in (25 mm) wide.
- Drive the stakes flush with the top of the sod. Use a minimum of 8 stakes per square yard (meter) to hold sod in place.
- Once sod is placed and staked as necessary, tamp or roll it using adequate equipment to provide good contact with soil.

- Use caution to prevent tearing or displacement of sod during this process. Leave the finished surface of sodded areas smooth and uniform.

7. Watering Sod

After the sod has been placed and rolled or tamped, water it to promote satisfactory growth. Additional watering will be needed in the absence of rainfall and during the hot dry summer months. Water may be applied by Hydro Seeder, Water Truck or by other means approved by the Engineer.

8. Dormant Sod

Dormant Bermuda grass sod can be installed. However, assume responsibility for all sod through establishment and until final acceptance.

9. Establishment

Sod will be inspected by the Engineer at the end of the first spring after installation and at the time of Final Inspection. Replace any sod that is not live and growing. Any cost for replacing any unacceptable sod will be at the Contractor's expense.

I. Application of Nitrogen

Apply nitrogen at approximately 50 lbs/acre (56 kg/ha) when specified by the Engineer after plants have grown to 2 in (50 mm) high.

One application is mandatory and must be applied before Final Acceptance.

Apply nitrogen with mechanical hand spreaders or other approved spreaders capable of uniformly covering the grassed areas. Do not apply nitrogen on windy days or when the foliage is damp.

Do not apply nitrogen between October 15 and March 15 except in Zone 4. In planting zones 3 and 4 apply an additional application of nitrogen.

J. Application of Polyacrylamide (PAM)

1. Prepare soil according to project Plans and Specifications prior to applying PAM.
2. Apply PAM according to manufacturer's recommendations and the requirements listed herein.
3. Apply Polyacrylamide (PAM) to all areas that receive permanent grassing.
4. Apply PAM (powder) before grassing or PAM (emulsion) to the hydroseeding operation.
5. Use only anionic PAM.
6. Ensure that the application method provides uniform coverage to the target and avoids drift to non-target areas including waters of the state.
7. Achieve > 80% reduction in soil loss as measured by a rainfall simulator test performed by a certified laboratory (1 hour storm duration, 3 inches (75 mm) rainfall per hour).
8. Ensure uniform coverage to the target area and minimize drift to non-target areas. Apply anionic PAM to all cut and fill slopes, permanently grassed or temporarily grassed, either prior to grassing or in conjunction with hydroseeding operations. Mulch will not be eliminated.
9. Use application rates in accordance with manufacturer's instructions.
10. Do not exceed 200 lbs/acre/year (224 kg/ha/year).

700.3.06 Quality Acceptance

The Engineer may require replanting of an area that shows unsatisfactory growth for any reason at any time.

Except as otherwise specified or permitted by the Engineer, prepare replanting areas according to the Specifications as if they were the initial planting areas. Use a soil test or the Engineer's guidance to determine the fertilizer type and application rate, then furnish and apply the fertilizer.

700.3.07 Contractor Warranty and Maintenance

A. Plant Establishment

Before Final Acceptance, provide plant establishment of the specified vegetation as follows:

1. Plant Establishment

Preserve, protect, water, reseed or replant, and perform other work as necessary to keep the grassed areas in satisfactory condition.

2. Watering

Water the areas during this period as necessary to promote maximum growth.

3. Mowing

Mow seeded areas of medians, shoulders, and front slopes at least every 6 months. Avoid damaging desirable vegetation.

In addition, mow as necessary to prevent tall grass from obstructing signs, delineation, traffic movements, sight distance, or otherwise becoming a hazard to motorists.

Do not mow lespedezas or tall fescue until after the plants have gone to seed.

B. Additional Fertilizer Mixed Grade

Apply fertilizer at approximately 600 lbs/acre (675 kg/ha) each spring after initial plant establishment. Continue annual applications until Final Acceptance. This additional fertilizer will be measured and paid for at the Contract Unit Price for fertilizer mixed grade.

C. Growth and Coverage

Provide satisfactory growth and coverage, ensuring that vegetation growth is satisfactory with no bare spots larger than 1 ft² (0.1 m²). Bare spots shall comprise no more than 1 percent of any given area. An exception is given for seed not expected to have germinated and shown growth at that time.

D. Permissible Modifications

When all Items of the work are ready for Final Acceptance except for newly planted repaired areas or other areas with insufficient grass, the Contractor may fill the eroded areas or treat bare areas with sod obtained, placed, and handled according to [Subsection 700.3.05.H](#).

Carefully maintain the line and grade established for shoulders, front slopes, medians, and other critical areas.

Sod as described above will not be paid for separately, but will be an acceptable substitute for the satisfactory growth and coverage required under this Specification. These areas treated with sod are measured for payment under the Item for which the sod is substituted.

700.4 Measurement

No measurement to be included for this item.

700.4.01 Limits

General Provisions 101 through 150.

700.5 Payment

Payment will be made under CONSTRUCTION COMPLETE.

A. Permanent Grassing

Includes preparing the ground, seeding, wood fiber mulch, polyacrylamide, and providing plant establishment and other incidentals.

B. Straw or Hay Mulch

Includes straw or hay mulch.

C. Fertilizer Mixed Grade

Includes furnishing and applying the material.

D. Lime

Includes furnishing and applying the material.

E. Nitrogen

Includes furnishing and applying the material.

F. Sod

Includes ground preparation, including addition of topsoil, furnishing and installing live sod, and for Plant Establishment.

G. Temporary Grass

Includes temporary grass.

700.5.01 Adjustments

General Provisions 101 through 150.

Georgia Department of Transportation
State of Georgia
Special Provision

Project Number: CSNHS-0008-00(415)
P.I. Number: 0008415
Fulton County

Section 702—Vine, Shrub, and Tree Planting

Delete Section 702 and substitute the following:

702.1 General Description

This Work includes furnishing and planting vines, shrubs, trees and plants, as well as treating regenerated areas according to the Specifications, Plans, and the Engineer.

702.1.01 Definitions

General Provisions 101 through 150.

702.1.02 Related References

A. Standard Specifications

[Section 108—Prosecution and Progress](#)

[Section 700—Grassing](#)

[Section 882—Lime](#)

[Section 891—Fertilizers](#)

[Section 893—Miscellaneous Planting Materials](#)

B. Referenced Documents

Standardized Plant Names

702.1.03 Submittals

A. Certificates of Inspection

Submit certificates of inspection with the invoice for each shipment of plants as required by law for transportation.

File certificates with the Engineer before the material is accepted. Plants may be rejected at the site regardless of Federal or State government inspections at the place of growth.

B. Substitutions

When both primary and alternate plants are specified, use the alternate only after providing written proof that the primary plants specified are not available. In this case a Supplemental Agreement is not required to use the alternate plants.

When a primary or an alternate plant cannot be furnished, provide the Engineer written proof that neither is available. A Supplemental Agreement is required for substitute plants in this case.

702.2 Materials

Ensure that materials meet the requirements of the following Specifications:

Material	Section
Water	700.2.B
Agricultural Lime	882.2.01
Fertilizers	891.2.01
Plant Topsoil	893.2.01
Landscape Mulch	893.2.02
Vines, Shrubs, Trees, and Miscellaneous Plants	893.2.03
Tree Paint	893.2.06
Prepared Plant Topsoil	893.2.07
Stakes	893.2.08
Organic Soil Additives	893.2.09

A. Plant Specifications

Furnish plants according to the plant name and Specifications included on the Plans titled, "Plant Specifications."

1. Plant Names

Ensure that the botanical and common names of plants specified conform with the most current edition of Standardized Plant Names, as adopted by the American Joint Committee on Horticultural Nomenclature.

Plants should be clearly labeled at the nursery. Labels should remain on the plants until inspected by the engineer.

2. Grades

Ensure that plants meet the grade requirements of the most current American Nursery and Landscape Association ANSI Z60.1 and any other requirements.

Caliper used for establishing plant grades or trunk sizes is measured according to the American Nursery and Landscape Association ANSI Z60.1. Plant trees with straight stems and symmetrical branches according to their natural growth. Trees with broken or damaged terminal or main stems will be rejected. There should be one dominant leader to the top of the all large canopy shade trees. There can be a double leader in the top 10% of the tree.

Trees should be rooting into the root ball so that soil or media remains intact and trunk and root ball move as one when lifted, but not root bound. The trunk should bend when gently pushed and should not be loose so it pivots at or below the soil line.

There shall be no roots greater than 1/10 diameter of the trunk circling more than one-third the way around in the top half of the root ball. Roots larger than this may be cut provided they are smaller than one-third the trunk diameter.

The leaf-bearing crown should be full and uniform. Leaves should show no evidence of chlorosis, necrosis, disease or insect infestation.

3. Substitutions

Use approved substitute plants, as designated by the Engineer, equal in value to specified plants. Request substitutions at least 30 days before the end of the planting season in the area.

B. Nursery Plants

Unless otherwise specified, use plants stock-grown in a licensed nursery under intensive care and cultivation for at least one year. The largest branches of shade trees should be spaced at least 6 inches apart. The branch system shall be normally developed and free of disease, injurious insects, disfiguring knots, sun-scald, injuries, bark abrasions, dead or dry wood, broken terminal growth, or other disfigurements. Stems should show no evidence of die-back. Ensure that proper certificates of inspection and a complete list of the nursery growers accompany nursery grown plants. See [Subsection 893.2.03](#).

C. Collected Plants

Collected plants grow in the wild and are uncultivated and untransplanted. Do not take collected plants from areas infested with insects under quarantine. See [Subsection 893.2.03](#).

D. Approval and Selection of Materials and Work

Select materials and execute operations required under the Specifications and drawings with the approval of the Engineer. Remove rejected materials from the site promptly.

702.2.01 Delivery, Storage, and Handling

A. Bare-Rooted Plants

Tie bare-rooted plants in bundles and place moist sphagnum moss, shingletoe, or other moisture-retaining material around the roots to keep the plants moist for up to 10 days. Over-wrap the bundle with a heavy weight, waterproof, flexible material, covering the roots and one-half of the tops. Keep the plants wrapped until they are planted or heeled-in.

Wrapped plants may be held in the package for up to 10 days from shipment if protected from the sun and wind. If unable to plant plants within 10 days from shipment, unwrap, spread the roots, heel-in using moist soil, and water well.

Protect roots of plants that have been heeled-in from drying out. Cover soil and roots with wet canvas, burlap, or straw while transporting and distributing them for planting. The type of protection depends on weather conditions and the length of time the plants remain unplanted. Use protection methods satisfactory to the Engineer.

B. Balled and Burlapped Plants (B&B)

Ensure that the soil in the ball is the original and undisturbed soil in which the plant has grown.

1. Dig, burlap, transport, and handle the plant carefully to avoid loosening the soil (stripping or exposing the roots). Burlap shall be a natural biodegradable material. Do not use synthetic burlap.
2. Replace plants rejected because of broken or loose balls, or balls of less diameter than that specified.
3. Adequately protect the roots of balled and burlapped plants, unless they are planted immediately after they are delivered. Completely cover them with damp soil, sawdust, or other moist material until removing them for planting.
4. Keep plants moist while awaiting planting.
 - a. Do not saturate the ball, causing it to pull off in handling.
 - b. Handle B&B plants by the ball and not by the top growth.
 - c. Never leave the balls of plants unprotected overnight.

C. Container-Grown Plants

Keep container-grown plants moist until planted. Handle them by the container or soil ball and not by the top growth.

D. Collected Plants

Do not collect plants more than 24 hours before planting.

1. Select plants with good shape and form. Do not select poorly shaped, weak plants taken from dense shade and crowded conditions.
2. Dig collected plants with a wide root system equal to at least the spread of the top of the plant.
3. Protect the roots with a moist packing material.
4. Load them onto a covered truck, protected from the sun and wind and transfer them directly to the final planting site.
5. Prune collected plants by removing from one-third to one-half of the side branches as directed by the Engineer.

E. Heeled-in Plants

Properly maintain heeled-in plants until they are planted. Do not allow plants to remain heeled-in over the summer or for over 30 days without the Engineer’s consent.

F. Injury Prevention

In digging, loading, unloading, planting, or otherwise handling plants, avoid injuring the trunk, branches, and roots of the plants. Injured plants will be rejected. Protect tops of shrubs and trees while in transit to prevent windburn.

702.3 Construction Requirements

702.3.01 Personnel

General Provisions 101 through 150.

702.3.02 Equipment

General Provisions 101 through 150.

702.3.03 Preparation

A. Inspect Plants Before Digging

The Engineer will inspect trees or plants from the bidder’s source for acceptability. When rejecting the trees or plants, the Engineer reserves the right to pursue and examine other sources of plants to find acceptable specimens. This change will not constitute an increase in cost to the State.

B. Clear and Grub

Clear and grub before planting or beginning to prepare the plant bed. See [Special Provision 202](#)

C. Prepare Plant Bed

Prepare for planting as follows:

1. Planting Limits

Stake planting limits according to Plan details and the Engineer. Have the Engineer approve the method of plant identification before planting.
2. Applications of Soil Additives
 - a. Apply fertilizer approximately 3 lbs/100 ft² (1.5 kg/10 m²) of bed surface. Fertilizer for plant bed may be 6-12-12 if 4-12-12 is not available.
 - b. Apply agricultural lime for plant bed approximately 5 lbs/100 ft² (2.5 kg/10 m²) of bed surface.
 - c. Spread an organic soil additive, (See [Subsection 893.2.09](#)), evenly throughout the designated area to at least 2 in (50 mm) deep. Thoroughly dig it into the soil to at least 6 in (150 mm) deep using a rotary hoe type tiller or other equipment that evenly mixes the soil, lime, fertilizer, and organic soil additive.
 - d. Till the area until the surface is smooth and free of weeds, roots, rocks, and other debris, to the satisfaction of the Engineer.

702.3.04 Fabrication

General Provisions 101 through 150.

702.3.05 Construction

A. Seasonal Limitations for Planting

For geographic seasonal limitations, refer to the Planting Zones Map found in [Subsection 700.3.05](#). Plant in Zones 1 and 2 between October 15 and March 15. Plant in Zones 3 and 4 between November 1 and March 1.

B. Planting Operations

Plant using either the pit method or the dibble method as called for on the Plant Specification sheet. Before beginning planting of each area, have available the necessary materials including prepared plant topsoil (see [Subsection 893.2.07](#)), water, stakes, and mulch.

When seasonal limitations and weather conditions permit, continuously water, mulch, guy, and stake, until completing the last operation.

After completing planting, provide a method for retaining water adjacent to the plant according to the details shown on the Plans or as directed by the Engineer.

1. Planting By the Pit Method

a. Placing Bare-Rooted Plants

Plant bare-rooted plants delivered to the pit area. Protect roots from drying out until placing them in the pit.

- Center plants in pits and spread roots as they originally grew.
- Cover and prepare the topsoil according to details shown on the Plans.

b. Placing Balled and Burlapped Plants

Immediately plant these plants after they are delivered to the pit site. Never allow the balls to remain unprotected overnight.

- The pit diameter shall be a minimum of 3 times the diameter of the rootball. Center the ball in the prepared pit, leaving the top of the ball 1 in (25 mm) above the top of the ground for settlement.
- Cut away and remove the top 1/3 of burlap from the rootball. Cut all ropes and twine, pull the nails, and drop the remaining burlap to the bottom of the hole. Cut away and remove all wire from the root ball.
- Partially fill the pit with prepared plant topsoil and compact the soil enough to hold the ball firmly. Add mycorrhizal inoculant to plant topsoil if specified in plans.

c. Placing Container-Grown Plants

When the container is delivered to the pit site, split the container from top to bottom and carefully remove the plant.

- The pit diameter shall be a minimum of 3 times the diameter of the rootball. Spread into the hole any major roots growing around the container or prune them to remove any circular growth.
- Place the ball in the center of the prepared pit, leaving the top of the ball 1 in (25 mm) above the top of the ground for settlement.
- Partially fill the pit with prepared plant topsoil and compact the soil enough to hold the ball firmly. Add mycorrhizal inoculant to plant topsoil if specified in plans.

d. Completing Pit Plantings

After placing pit plantings, water plants thoroughly the same day regardless of weather or soil moisture conditions.

- After the water has soaked in, add prepared plant topsoil and compact firmly up to 2 in (50mm) below the adjacent ground.

- Stop compacting when the compacted prepared topsoil is 2 in (50 mm) below the adjacent ground.
- Fill the remainder of each pit with loose, prepared plant topsoil according to the details shown on the Plans.
- Prepare the loose topsoil to retain water adjacent to the plant according to the Plans or as directed by the Engineer.

2. Planting By the Dibble Method

If the Plans require the dibble method, perform the Work as outlined. Standard dibble blades are made in 10 in (250 mm) and 12 in (300 mm) heights. Use the 12 in (300 mm) blade on all plants except those with a root system of 8 in (200 mm) or less.

Locate plants as shown on the Plans or as approved by the Engineer. Only plant when there is adequate moisture in the ground and when the ground is not frozen.

Follow these steps when grass or other vegetation is present:

- Mow an area at least 2 ft (600 mm) on all sides of the proposed location of the individual dibbled plants to a height of 1 in (25 mm).
- Apply landscape mulch of the specified type and amount to the mowed area before planting.
- Dibble the seedling into the soil.
- Dibble the plant within 48 hours after mowing.
- Complete each planting according to the Plan details to retain water adjacent to the plant.

C. Landscape Mulching

1. For Pit Plantings

Follow these requirements when mulching for pit plantings:

- Where the distance between plants is 8 ft (2.4 m) or less, spread mulch throughout and 3 ft (900 mm) beyond the outermost plants. Where plants are more than 8 ft (2.4 m) apart, apply mulch in a circular fashion around each plant, forming a ring 5 ft (1.5 m) in the outside diameter.

If plant pits are greater than 5 ft (1.5 m) in diameter, ensure that the mulch extends out to cover the berm as shown in the planting details on the Plans.

- Apply mulch within 3 days of planting at least 4 in (100 mm) in depth to obtain a compacted depth of at least 3 in (75 mm).

Compaction occurs naturally. Check compaction at least two months after spreading and exposing the mulch to the elements.

If the compacted depth is less than 3 in (75 mm), apply additional mulch to deficient areas within 1 month following notification.

- Apply mulch to a uniform depth and remove lumps for a neat appearance. Tuck mulch neatly against all paving edges, drainage structures, and where planting beds meet grassed areas.
- Leave a 1 in (25 mm) to 2 in (50 mm) ring of non-mulched area directly around all tree trunks.
- Do not mulch with Cypress Mulch.

2. For Plantings by the Dibble Method

Apply landscape mulch according to [Subsection 702.3.05.C.1](#) with the following exceptions:

- Apply mulch before planting.
- Ensure that the minimum compacted height after 2 months exposure is 2 in (50 mm).

D. Wrapping

Do not wrap the trunks of tree unless specified in the plans. When wrapping is specified, tightly wrap the trunks of deciduous trees over 1.25 in (32 mm) in caliper. Wrap in strip burlap or waterproof crepe tree wrapping paper or other approved materials.

1. Begin wrapping at the ground and extend spirally up and beyond the first rosette of branches with an overlap of one half the width of the wrapping material.
2. Tie the wrapping material securely with binder twine spaced every 12 in (300 mm) for the full length of the wrapping. Wrap immediately after planting.

E. Staking and Guying

1. Perimeter Staking

Place perimeter stakes 2 in x 2 in x 36 in (50 mm x 50 mm x 900 mm). Stake the perimeter of indicated regenerated areas within specified planting dates according to the Plans or as directed by the Engineer.

2. Vine, Shrub, and Miscellaneous Plant Staking

Use stakes to identify isolated vines, shrubs, and miscellaneous plants outside of solid mulched beds according to Plan details.

3. Tree Staking and Guying

Stake trees with an identification stake and guy according to the details and dimensions shown on the Plans. Each guy wire shall consist of 18-gauge (1.2 mm) malleable galvanized iron wires twisted into a single strand and enclosed loosely into a rubber hose (or other approved covering or guying materials) extending around the trunk. Replace at no additional expense to the Department, any staking and guying materials that break or loosen.

Nylon guying straps of accepted size and quality may be substituted for the hose and wire specified above.

- a. After fastening the wire to the stake by tying or twisting it into a figure-8, nail or staple the wire to the stake to prevent slippage using a 4d nail or a 0.5 in (13 mm) staple.
- b. Tighten the wire so that twisting the wire causes a slight strain between the tree and the stake.
- c. Place guy wires above the first rosette of lower branches and fasten wire to the stake approximately 6 in (150 mm) above the ground.

F. Pruning

1. Prune plants on the site before planting and after initial inspection by the Engineer. Never prune severely to get plants to meet Specifications.
 - a. Follow modern horticultural practices and use approved tools designed for pruning. Lopping, topping, or shearing trees or shrubs will result in rejection.
 - b. Prune back damaged, scarred, frayed, split, and skinned branches, limbs, and roots to live wood nearest to the next sound, outside lateral bud, branch, limb, or root.
 - c. Leave the terminal leaders or buds in trees intact.
 - d. Remove approximately one-third of the smaller branches on nursery grown vines, shrubs, and trees for root-top balance.
 - e. Prune roots, when necessary, as directed by the Engineer.
 - f. Prune Crape Myrtles to maintain natural form only. Severely cutting back crape myrtles is not permitted. Remove sucker growth from Crape Myrtles.

G. Watering

1. Apply water in a manner to prevent erosion. Water plants at the time of planting. Water after applying fertilizer called for in [Subsection 702.3.05.H](#) and as necessary to maintain enough moisture to promote plant growth. Use tree gator watering bags or approved equivalent if specified in plans.
 - a. Apply enough water to wet the soil to a depth slightly below the roots. Direct the water to the ground around the plant, not the tops.
 - b. Do not allow plant foliage to dry out or plants to defoliate from lack of water. Remove plants in such condition from the site immediately.

- c. Apply water once per week throughout the planting season in which the plants are installed. Follow [Subsection 702.3.07.B](#) and [702.3.07.C](#) for shrub and tree watering requirements throughout the life of the project.

H. Spring Application of Fertilizer

1. Method and Rate of Application

Follow these requirements when applying fertilizer in the spring:

a. Trees

Deep-root feed trees each spring by using a 8-12-12 slow release fertilizer. Bore a 1.5 in (38 mm) diameter hole between 18 in to 24 in (450 mm to 600 mm) deep at the rate of 8 to 10 holes per tree.

Use 1 cup (0.25 L) of fertilizer per 1 in (25 mm) in caliper of tree measured 6 in (150 mm) off the ground. Fill the holes with soil upon completing each hole.

b. Shrubs

Fertilize shrubs with a 6-12-12 slow release 60 percent organic fertilizer by spreading fertilizer around the base of the plant and working it into the soil by hand. Use 0.5 cup (0.12 L) of fertilizer per foot (300 mm) of shrub height.

c. Bed Areas

Spread fertilizer on bed areas (defined by method of planting in [Subsection 702.3.05.B](#)), over the mulch at the rate of 3 lbs/100 ft² (1.5 kg/10 m²) using 6-12-12 or 8-12-12. Thoroughly water in the plants.

d. Vines

Fertilize vines when not planted in a bed at the rate of 1/4 cup (60 ml) per vine using 6-12-12 or 8-12-12. Thoroughly water in the plants.

e. Regenerated Areas

Spread fertilizer on regenerated areas evenly at a rate of 3 lbs/100 ft² (1.5 kg/10 m²) and thoroughly water in using 6-12-12.

NOTE: 2 cups (1 L) of 6-12-12 or 8-12-12 equals 1 lb (1 kg).

2. Time of Application

Apply fertilizer in the spring in Zones 1 and 2 (with reference to the Planting Zones specified in [Subsection 702.3.05.A](#)) between April 1 and April 15. Apply between March 15 and April 1 for Zones 3 and 4.

For late plantings, do not apply fertilizer less than 30 days after the plantings.

3. Additional Fertilizer Grades 8-12-12 or 6-12-12

Approximately one month after the spring fertilizer is applied, the Engineer will inspect planted areas and determine if an additional application of fertilizer is needed for any plant or group of plants.

If the Engineer determines additional fertilizer is required, apply fertilizer at the rate specified in [Subsection 702.3.05.H](#). Make the additional application between June 15 and July 15th.

I. Treatment of Regenerated Areas

Treating regenerated areas includes staking the perimeter and applying fertilizer in the spring.

Pruning, mulching, staking (except perimeter staking), guying, mowing, weeding, and watering (except watering following fertilization) are not required.

Perform perimeter staking as specified in [Subsection 702.3.03.C.1](#). Apply fertilizer in the spring as specified in [Subsection 702.3.03.C.2](#).

J. Restoration and Cleanup

Restore areas where existing grass has been damaged or scarred during planting operations at no expense to the Department. Restore the disturbed areas to their original conditions as directed by the Engineer. Clean up debris, spoil piles, and containers and leave the Project area clean.

702.3.06 Quality Acceptance

Preserve the plants in a healthy growing condition. The acceptability of the plant material planted and maintained as specified will be determined at the end of an establishment period.

The plant establishment period is the period from the last planting specified in [Subsection 702.3.05.B](#) until the following October 1. Plant all plants in one planting season unless otherwise approved by Engineer.

A. First Establishment Period

At the end of the first planting season, the first establishment period begins. The Department will make the first semi-final inspection 30 days before the end of the first establishment period. Replace dead, dying, diseased, unsatisfactory, and missing plants, by January 20 of the next (second) planting season.

B. Second Establishment Period

At the end of the second planting season, the second plant establishment period begins. The Department will make the second semi-final inspection 30 days before the end of the second establishment period. Again, replace dead, dying, diseased, unsatisfactory, and missing plants, by January 20 of the next (third) planting season.

C. Final Inspection

The Department will make the final inspection of the plants during May, following any needed replacements during the previous planting season. Assume responsibility for the plants until the Final Acceptance of the Project or a portion of the Project.

702.3.07 Contractor Warranty and Maintenance

Project maintenance includes, but is not limited to, watering, cultivating, weeding, pruning, repairing, adjusting guys and stakes, and performing other work as ordered by the Engineer until final acceptance.

Promptly remove from the Project area dead plants or those that no longer conform to the requirements of [Subsection 702.2.A.2](#).

Mow the entire right-of-way within the limits of the Project up to a maximum of four times per calendar year.

A. Leaning Trees

Straighten leaning trees as directed by the Engineer. Follow Staking and Guying requirements for replacements or repairs as per [Subsection 702.3.05.E](#).

B. Shrub Maintenance

1. Pruning

Prune or thin shrubs, as directed by the Engineer, at least two times per year, once before spring and once during mid-summer. Maintain an attractive shape and fullness with respect to the intended character of the planting. See [Subsection 702.3.05.F](#).

2. Landscape Mulching

Continuously maintain shrub and tree beds with a clean, freshly mulched appearance using the mulch originally specified. See [Subsection 702.3.05.C](#).

a. Apply a 2 in (50 mm) loose layer of specified mulch (top-dressing) on top of all areas, including tree pits, initially mulched, at the following times:

- In August, during the first plant establishment period.

- In April, during the second plant establishment period.
 - In August, during the second plant establishment period.
 - In April, prior to the final inspection.
3. Applying Fertilizer
See [Subsection 702.3.05.H](#).
 4. Applying Pesticides
 - a. Inspect all planted or seeded vegetation for insects, grubs, mites, diseases, etc., once every two weeks. Apply insecticides, fungicides, and herbicides according to the manufacturer's recommendations to effectively control or eradicate the problem.
 - b. Perform all pesticide applications under the direct supervision of a trained licensed commercial pesticide operator whose license includes subcategory 27 – Right of Way Pest Control. Carry the pesticide license/certification on the work site during applications. Carry all labeling associated with the chemical being applied at the work site.
 - c. Submit all product information data sheets and EPA approval numbers on all pesticides proposed to be used prior to application for approval.
 - d. Notify the Engineer a minimum of 48 hours prior to any and all pesticide applications.
 - e. Add a blue dye to all spray applications unless approved otherwise by the Engineer.
 - f. Monitor the weather and spray under proper weather conditions. Spraying shall not occur when the weather is greater than 10 miles per hour.
 - g. Wear the proper safety attire. Wear long sleeve shirts, long pants, gloves, and safety glasses. Wear or use any additional protective safety attire or gear as recommended by the product's manufacturer.
 - h. Repair any damage that is a result of mishandling or misuse of materials, at no expense to the Department, to the satisfaction of the Engineer.
 5. Edging
 - a. Edge all shrub pits, shrub beds, and tree pits twice a month throughout the life of the project such that the vee-cut edging detail specified on the plans is maintained. Prevent grass and weeds from growing over or into the shrub beds and tree pits.
 - b. Use equipment specifically designed for edging. Line trimming equipment shall not be used.
 6. Watering
 - a. Check all planted material once a week throughout the contract for dryness by removing the mulch from their base and "sampling the soil" approximately 4 in (100mm) deep. Water if the soil is not moist.
 - b. Water all planted material if a drought (no rain for two weeks) occurs. Provide the water required to meet the watering requirements.
 - c. Water each plant thoroughly until the ground is saturated to a depth slightly below the root ball. Apply water in a manner to prevent erosion.
 7. Weed Control
Perform weed control throughout the project, a minimum of once every two weeks, in all areas within the project limits to maintain tree pits, shrub beds, sidewalks, curb and gutter, walkways, ditch paving, concrete medians, and other pavement weed free. Meet the following conditions:
 - a. Perform weed control to prevent weeds from becoming established, setting seed, or from becoming visible in the planting beds.
 - b. Completely remove all undesirable plants (weeds) by hand pulling. Removal of weeds may be accomplished using herbicides if approved by the Engineer.
 - c. Apply an approved pre-emergent herbicide twice each year, once in the spring and once in the fall, throughout the contract. Apply pre-emergent to all shrub beds and tree pits. Notify the Engineer 48 hours prior to spraying. Use a blue dye in all applications unless approved otherwise by the Engineer.

- d. If noted on plans, eradicate all invasive exotic pest plants found within the project limits throughout the life of the project.
 - e. Dispose off site on a daily basis all weed, exotic plants, clippings, litter, and debris generated.
8. Policing
Remove debris such as paper, broken limbs, bottles, cans, etc., a minimum of the first and third week of each month from all areas within the project limits while maintaining the site.

C. Tree Maintenance

- 1. Watering
See [Subsection 702.3.07.B.6](#)
- 2. Landscape Mulch
See [Subsection 702.3.07.B.2](#)
- 3. Fertilizer
See [Subsection 702.3.05.H.](#)
- 4. Abnormal Conditions
Periodically (once every two weeks) observe trees and shrubs for abnormal conditions such as insects, borers, web worms, red spiders, etc., and immediately treat.
- 5. Sucker Growth
Remove sucker growth once a month. Sucker growth is the shoots that sprout out around the base of the tree trunk.
- 6. Pruning and Deadwood
Remove deadwood at least two times a year. Prune dead branches. Paint cuts, and wounds or scars with tree paint only when specified in the plans. Do not top Crape Myrtles. See [Subsection 702.3.05.F.](#)
- 7. Pesticide Control

Apply pesticides as necessary to control bores, aphids, mealy bugs, mites, and tent worms, and diseases. Follow the manufacturer’s instructions. . See [Subsection 702.3.07.B.4.](#) NOTE: Use chemicals according to Federal, State and county directives on environmental control that carry an EPA approval number.

- 8. Weed Control
See [Subsection 702.3.07.B](#)
- 9. Staking and Guying
Remove all guy wires/nylon strapping and stakes from plants which have gone through one complete growing season.

702.4 Measurement

- A. Plants** – not measured separately.
Plants must be living and in an acceptable condition at the time of Final Acceptance according to approved plan.
- B. Fertilizer** – not measured separately.
Spring application fertilizer applied to planted and regenerated areas is include in price bid for project. Fertilizer, lime, and plant topsoil used in prepared plant topsoil or plant bed preparation are not measured for separate payment.

- C. **Perimeter Stakes** – not measured separately.
- D. **Clearing and Grubbing** – not measured separately
- E. **Landscape Mulch** – not measured separately.

The quantity of landscape mulch and top-dressing is included in price bid for project. The presence of weeds or other growth, or foreign material, will be cause for rejection of pay request. The addition of landscape mulch in deficient areas will not be measured for payment.

702.4.01 Limits

General Provisions 101 through 150.

702.5 Payment

- A. **Plants** – paid for under CONSTRUCTION COMPLETE.

Includes furnishing, planting, replanting as required, pruning, staking, guying, soil conditioning, and preparing plant beds, including applying additives, digging plant pits, preparing plant topsoil and mulch, disposing of waste material, and maintaining the plants during the plant-establishment period.

- B. **Fertilizer** – paid for under CONSTRUCTION COMPLETE.

Includes furnishing and applying and for watering regenerated areas.

- C. **Perimeter Stakes** – paid for under CONSTRUCTION COMPLETE.

- D. **Landscape Mulch** – paid for under CONSTRUCTION COMPLETE.

Includes furnishing, installing, topdressing, and maintaining mulch as required.

702.5.01 Adjustments

General Provisions 101 through 150.

Office of Maintenance

**DEPARTMENT OF TRANSPORTATION
STATE OF GEORGIA
SPECIAL PROVISION**

Project Number: CSNHS-0008-00(415)

P.I. Number: 0008415

Fulton County

Section 814—Soil Base Materials

Delete 814.2.02 and substitute the following:

814.2.02 Soil-Cement Material

A. Requirements

1. Ensure that the material for soil-cement base will:
 - a. Meet the requirements of [Subsection 810.2.01](#) for Classes IA1, IA2, IA3, or IIB1 with the following modifications:

Clay content	5 to 25%
Volume change	18% maximum
Liquid Limit	25% maximum
Plasticity Index	10% maximum
Maximum dry density	95 lb/ft ³ (1520 kg/m ³) minimum
Sulfates	4000 ppm maximum
pH	4.0 minimum

- b. Be friable and not contain large amounts of heavy or plastic clay lumps, organic material, roots, or other substances that would interfere with how the Portland cement sets, plant production, or the finished surface of the base and meet the requirements of [Subsection 301.3.05.A.2, “Pulverization”](#) or [Subsection 301.3.05.B.1, “Soil”](#).
 - c. Produce a laboratory unconfined compressive strength of at least 450 psi (3.1 MPa). To make the sample, mix in a minimum of 5percent to a maximum of 9 percent Type I Portland cement, moist-cure for 7 days, and test with [GDT 65](#).
2. Analyze the soil-cement design and create a Job Mix Formula for each Project where soil-cement base or subbase is specified. Have the Job Mix Formula approved by the Engineer before starting base or subbase construction.
3. You may use fly ash or slag that meets the requirements of [Subsection 831.2.03](#) as admixtures for poorly reacting soils when the blend of soil and fly ash, or slag, meets the design requirements in this Subsection.
4. Ensure that subgrade material used underneath the soil-cement base meets the sulfate and pH requirements of this subsection (See Subsection 209.3.05.A.7).

B. Fabrication

General Provisions 101 through 150.

C. Acceptance

Test as follows:

Test	Method
Soil gradation	GDT 4
Volume Change	GDT 6
Maximum density	GDT 7 or GDT 67
Soil-Cement Design	GDT 65
pH	GDT 98
Sulfates	ASTM D 516
Liquid Limit	AASHTO T 89
Plastic Limit and Plasticity Index	AASHTO T 90

D. Materials Warranty

General Provisions 101 through 150.

Office of Materials and Research

**DEPARTMENT OF TRANSPORTATION
STATE OF GEORGIA**

SUPPLEMENTAL SPECIFICATION

Project Number: CSNHS-0008-00(415)

P.I. Number: 0008415

Fulton County

Section 820—Asphalt Cement

Delete Section 820 and substitute the following:

820.1 General Description

This Section includes the requirements for asphalt cements prepared from crude petroleum.

820.1.01 Related References

A. Standard Specifications

General Provisions 101 through 150.

B. Referenced Documents

Standard Operating Procedure (SOP 4)

AASHTO R 28

AASHTO T 48

AASHTO T 179

AASHTO T 240

AASHTO T 313

AASHTO T 314

AASHTO T 315

AASHTO T 316

820.2 Materials

820.2.01 Asphalt Cement

A. Requirements

Type

Use a homogenous, water-free material that does not foam when heated to 347 °F (175 °C).

Ensure blend used to produce a specified performance grade meets the following requirements:

- Uniform and homogeneous without separation
- Uses PG 64-22 or PG 67-22 described below for the base asphalt
- Ensure production materials have not been “air-blown or acid modified” to achieve the performance grade

Grade

Use the various grades of asphalt cement meeting the requirements shown in the test requirements for Petroleum Asphalt Cements

Add only Styrene-Butadiene-Styrene (SBS) or Styrene-Butadiene (SB) to neat asphalt to produce a binder meeting requirements for PG 76-22.

Test Requirements for Petroleum Asphalt Cements

Test And Method	Test Temperature				Original Binder	Residue Of Binder After:	
	PG 58-22 (Note e)	PG 64-22	PG 67-22	PG 76-22 (Note d)		Rolling Thin Film Oven, AASHTO:T 240	Pressure Aging AASHTO: R 28
Flash Point, Min., AASHTO T 48					446 °F (230 °C)		
Viscosity, Max., AASHTO T 316, (Note a)	275 °F (135 °C)				3Pa-S (3000CP)		
Mass Loss (%), Max., AASHTO T 240, (Note b)						0.5	
Dynamic Shear, G*/sin δ, AASHTO T 315, 10 Rad/Sec	136 °F (58 °C)	147 °F (64 °C)	153 °F (67 °C)	169 °F (76 °C)	≥ 1.0 kPa	≥ 2.2 kPa	
Dissipated Energy, Dynamic Shear, G*·sin δ, AASHTO T 315, 10 Rad/Sec	72 °F (22 °C)	77 °F (25 °C)	80 °F (26.5 °C)	88 °F (31 °C)			≤ 5000 kPa
Creep Stiffness, 60 sec., AASHTO T 313, (Note c)	10 °F (- 12 °C)						S ≤ 300 000 kPa m ≥ 0.300
Direct Tension, 1.0 mm/min., AASHTO T314, Failure Strain	10 °F (- 12 °C)						Report

Notes:

- a. The Department may waive this requirement if the supplier warrants the asphalt binder can be adequately pumped and mixed at temperatures meeting all applicable safety standards.
- b. Heat loss by AASHTO: T 179 may be accepted in lieu of mass loss by AASHTO: T 240.
- c. If the creep stiffness is below 300 000 kPa, the direct tension test is not required. If the creep stiffness is ≥300 000 kPa, report the Direct Tension Failure Strain value. Satisfy the m-value requirement in either case.
- d. The maximum Phase Angle measured by DSR shall be ≤ 75 degrees.
- e. The maximum Mass Loss shall be ≤ 1%, when used in conjunction with Bituminous Surface Treatment (Section 424).

If modification is required, thoroughly blend the composite materials at the supply facility prior to being loaded into the transport vehicle. Ensure all blending procedures, formulation, and operations are approved by the Office of Materials and Research.

3. Certification: Provide certified test results from an approved, certified laboratory of blends for proposed PG asphalt for each specification characteristic of the asphalt cement proposed for shipment. Provide the certified results to the State Materials and Research Engineer as required in Standard Operating Procedure (SOP 4).

In the event there is reason to suspect a sample will be outside specification limits, the State Materials and Research Engineer may interrupt production until test results are known.

B. Materials Warranty

General Provisions 101 through 150.

**DEPARTMENT OF TRANSPORTATION
STATE OF GEORGIA**

SUPPLEMENTAL SPECIFICATION

**Project Number: CSNHS-0008-00(415)
P.I. Number: 0008415
Fulton County**

Section 863—Preservative Treatment of Timber Products

Delete Section 863 and Substitute the following:

863.1 General Description

This section includes the requirements for applying preservatives, conditioning, treating, inspecting, marking, testing, and documenting the necessary information for treated timber used in Department Work.

863.1.01 Related References

A. Standard Specifications

General Provisions 101 through 150.

B. Referenced Documents

American Wood Preservers Association (AWPA), C14, “Wood for Highway Construction— Preservative Treatment by Pressure Method”

AWPA C2

AWPA M2

AWPA M3

AWPA P9

AASHTO M 133

[QPL 50](#)

863.2 Materials

863.2.01 Conditioning and Preservative Treatment

A. Requirements

1. Condition and preservative treat all timber products to meet the requirements of American Wood Preservers Association (AWPA) Standard C14, “Wood for Highway Construction—Preservative Treatment by Pressure Method,” except as described in this Section.
2. Treatment Plants

Ensure treatment plants comply with quality control procedures in AWPA M3.

 - a. To expedite the work, a commercial inspection agency approved by the Department will inspect and test all treated timber products, including any preservative treatment at the treatment plant before it is delivered to the project. The treatment plant shall bear all the cost associated with the inspection and test.
 - b. Before requesting an inspection, the authorities of the treatment plant shall acquaint themselves with the timber specification requirements and shall segregate the material to be inspected for Department work from other stock.

3. Preservatives

Use preservatives that meet the requirements in the AWPA Standard, unless otherwise specified in the Plans or the Specifications.

- a. You may select one of three preservatives (creosote, pentachlorophenol, Chromated Copper Arsenate (CCA)) from the Materials and Usage Table in AWPA C14.
- b. Ensure pentachlorophenol solutions have at least 5 percent pentachlorophenol, by weight, dissolved in the petroleum solvents specified or pentachlorophenol in AWPA P9, Type "A."

B. Fabrication

- 1. As practicable, cut, frame, and bore timber before treatment.
- 2. Condition the timber first. For Southern Pine species, use the following treatment:

Penta-petroleum	Dry in kiln to 30% average moisture content or less or condition in steam
Chromated Copper Arsenate (CCA)	Dry in kiln to 25% average moisture content or less

NOTE: Do not heat the wood in the preservative, and do not use Boulton drying.

3. Preservative Penetration

Ensure the preservative penetrates at least 3 in (75 mm) or 90 percent of the sapwood for all lumber, timber, wood fence posts, and ties in contact with the ground.

- a. Ensure lumber, timber, and ties that do not contact the ground meet AWPA C2 requirements.
- b. Ensure preservative penetrates all other materials, piles, and poles according to applicable AWPA requirements.

4. Preservative Retention

Treat guard rail posts and offset blocks with pentachlorophenol or CCA with a minimum 0.6 lb/ft³ (9.6 kg/ m³) retained in the outer 0.6 in (15 mm), as required in AWPA C14 and C2.

5. Retreatment:

You may retreat a charge of material, or a portion of it, if the initial treatment does not meet requirements for retention, penetration, or appearance. The Department will allow only one retreatment.

NOTE: The Department will reject any damage due to retreatment.

6. Conditioning after Treatment

- a. Condition material that is dust-free.
- b. For lumber or timber that is treated with water-borne preservative and is to be painted, dry by air, kiln, or some method of artificial conditioning, to a moisture content of not more than 19 percent of the weight of the oven-dry wood.
- c. Protect the treated lumber from the elements with a prime coat of paint or other approved means.
- d. Ensure the moisture content does not rise above 19 percent before applying the first coat of paint.
- e. Dry material treated with water-borne preservative that will not be painted to surface dryness in air or otherwise before installing it.

C. Acceptance

1. Inspection

The Department will sample and test preservatives according to the requirements of AASHTO M 133.

NOTE: Check [QPL 50](#) for pre-approved manufacturers that supply material compliant with this specification.

- a. The Department will determine the level of preservative retention by testing the 0.6 to 1.5 in (15 to 38 mm) assay zone.
- b. Unless otherwise provided, an approved commercial inspection agency will inspect treated timber products according to AWPA M2.
- c. The Inspector will test before, during, and after treating.

2. Marking

The Inspector will mark each acceptable piece with a hammer stamp before and after treatment.

- a. Stamp only 25 percent of the offset blocks after treatment.
- b. Ensure that both inspection stamps identify the Inspector. Ensure that the before-treatment stamp is clearly distinguished from the after-treatment stamp.

3. Reporting

The Inspector from an approved commercial inspection agency shall:

- a. Prepare reports of the treating process and results of the inspection that confirm treatment was completed according to these Specifications.
- b. Furnish these reports to the Office of Materials and Research.
- c. Report according to AWPA M2.
- d. Get a shipping report from the treatment plant showing the project number, purchaser, sizes and amounts of materials, and preservative type for each shipment for Department Work.
- e. Furnish the shipment report and the treatment report to the Office of Materials and Research.

D. Materials Warranty

1. Retest treated material that has been in stock for two years before using.
2. The Department will reject any materials that fail to meet specifications unless they are retreated to meet all applicable requirements.

Office of Materials and Research

Georgia Department of Transportation

State of Georgia

Special Provision

PROJECT NO.: CSNHS-0008-00(415), FULTON COUNTY

P.I. NO.: 0008415

Section 865—Manufacture of Prestressed Concrete Bridge Members

Delete Subsection 865.1 and substitute the following:

This section includes the following requirements for precast-prestressed concrete bridge members and piling using High Performance Portland cement concrete as shown in the Plans:

- Manufacturing
- Inspecting
- Testing
- Marking
- Painting
- Rubbing as specified
- Plant handling
- Storing
- Shipping

The term “precast-prestressed concrete” is referred to as “prestressed concrete” in the rest of this Section.

Add the following to Subsection 865.2:

Material	Section
Concrete, Class AAA HPC	500

Add the following to the end of Subsection 865.2.01.B.7.a.6:

Optional Method of Curing for Release Strengths with HPC: Temperature match curing (“Sure Cure” or equivalent methods) is allowed for specimens used to determine when stress may be transferred to the concrete for High Performance Concrete Units.

GEORGIA DEPARTMENT OF TRANSPORTATION

STATE OF GEORGIA

SPECIAL PROVISION

Project Number: CSNHS-0008-00(415)

P.I. Number: 0008415

Fulton County

Section 881- Fabrics

Add the following to Subsection 881.2.08:

881.2.08 Filter Fabric for Embankment Stabilization

A. Requirements

1. Use woven filter fabric for embankment stabilization.
2. Sew fabric with a lock stitch using high strength polypropylene or nylon thread.
3. Obtain approval of the stitch and sewing method from the Engineer prior to use.
4. Use fabric that meets the following minimum tensile strength requirements:

Fabric Type	Tensile Strengths in lbs/in (kN/m) width			
	Warp Direction		Fill Direction	
	5% Strain	Ultimate	5% Strain	Ultimate
Polyester	200 (35)	500 (87.5)	100 (17.5)	250 (43.8)
Polypropylene	200 (35)	800 (140)	100 (17.5)	400 (70)

Minimum Seam Strength = 100 lbs/in (17.5 kN/m) width

- a. Tensile strengths at 5% strain are based on reduction factors from the ultimate strengths of 0.4 for polyester and 0.25 for polypropylene fabrics.
 - b. Use of reduction factors other than those shown are allowed only if verified by laboratory tests acceptable to the Department.
5. Submit a certification from the manufacturer that shows the physical properties of the material used and how it meets this Specification. Submit the certificate according to Subsection 106.05, "Materials Certification."

8.2.15

B. Fabrication

General Provisions 101 through 150.

C. Acceptance

Test according to the following:

Test	Method
Tensile strength, elongation	ASTM D 4595 Wide Strip Test
Seam Strength	ASTM D 4884 Wide Strip Test

1. Run the tests at a strain rate of 10% per minute.
2. Use a pre tensioning load of 10 lbs/in (1.75 kN/m) or 3%, whichever is less.

D. Materials Warranty

General Provisions 101 through 150.

**DEPARTMENT OF TRANSPORTATION
STATE OF GEORGIA
SPECIAL PROVISION**

**Project Number: CSNHS-0008-00(415)
P.I. Number: 0008415
Fulton County**

Section 894—Fencing

Delete Subsection 894.2.0.6.A and substitute the following:

894.2.06 Silt Fabric Fencing

A. Requirements

1. Fabric
 - a. See [Subsection 881.2.07, “Silt Fence Filter Fabric.”](#) for the types of fabric available.
 - b. Use a woven wire support fence or a polypropylene support mesh with Type “C” fence.
 - 1) Woven Wire Support Fence
 - a) Ensure the woven wire support fence is at least 26 inches (660 mm) high with at least 6 horizontal wires.
 - b) Ensure the vertical wires have a maximum spacing of 12 in (155 mm).
 - c) Ensure the top and bottom wires are at least 10 gauge (2.49 mm) and all other wires are at least 12-1/2 gauge (2.03 mm). Use Washburn and Moen Standard requirements for determining wire gauge.
 - d) You may use other designs subject to approval by the Office of Materials and Research.
 - 2) Polypropylene Support Mesh
 - a) Ensure the polypropylene support mesh is sewn to the fabric 2 in (50 mm) \pm 1 in (25 mm) from top and bottom of fabric and 11 in (279 mm) \pm 1 in (25 mm) from top and bottom of fabric. Use a T-90 black polyester thread to sew mesh to fabric with a lock stitch at 5 to 7 stitches per inch.
 - b) Ensure the height of the polypropylene support mesh is at least 36 in (914 mm) with a plus tolerance of 1 in (25 mm).
 - c) Ensure the polypropylene support mesh minimum tensile strength in the machine direction is 60 lb/3 inches and 72 lb/3 inches in the transverse direction.
 - d) Ensure minimum average weight of the polypropylene support mesh is 10.3 lb/1000 ft².
 - e) Ensure the average strand count of the polypropylene support mesh in the machine direction is 9.0 \pm 1.5 per 10 inches and 14.5 \pm 0.7 per 10 inches in the transverse direction.
 - f) Ensure the polypropylene support mesh contains stabilizers and/or inhibitors that make the mesh resistant to deterioration from exposure to sunlight or heat.
2. Posts

Use post sizes and types as determined by the type of fence being installed. Generally hardwood posts will be limited to ash, hickory, or oak. Other hardwoods may be acceptable if approved by the Office of Materials and Research.

- a. Type "A" Fence: Use either wood or steel posts that are at least 4 ft (1.2 m) long.
 - 1) If using soft wood, use posts that are at least 3 in (75 mm) in diameter or nominal 2 x 4 in (33 x 89 mm) and straight enough to provide a fence without noticeable misalignment.
 - 2) If using hardwood, use posts that are 1-1/2 x 1-1/2 in (38 x 38 mm) with a minus tolerance of 3/8 in (9 mm) providing the cross sectional area is at least 2.15 in² (1385 mm²).
 - 3) If using steel, use posts that are "U," "T," or "C" shaped with a minimum weight of 1.15 lb/ft (1.7 kg/m), and have projections for fastening the fence to the posts.
- b. Type "B" Fence: Use either wood or steel posts that are at least 3 ft (900 mm) long.
 - 1) If using soft wood, use posts that are at least 2 in (50 mm) in diameter or nominal 2 x 2 in (33 x 33 mm).
 - 2) If using hardwood, use posts that are 1 x 1 in (25 x 25 mm) with a minus tolerance of 1/4 in (6 mm) providing the cross sectional area is at least 0.95 in² (610 mm²).
 - 3) If using steel posts, use types "U," "T," or "C" shapes with a minimum weight of 0.75 lb/ft (1.1 kg/m).
- c. Type "C" Fence:
 - 1) Woven Wire Supported: Use only steel posts with a minimum length of 4 ft (1.2 m). Use "U," "T," or "C" shaped posts with a minimum weight of 1.15 lb/ft (1.7 kg/m). Use posts that have projections for fastening the woven wire and filter fabric.
 - 2) Polypropylene Mesh Supported: Use either wood or steel posts that are at least 4 ft (1.2 m) long.
 - a) If using soft wood, use posts that are at least 3 in (75 mm) in diameter or nominal 2 x 4 in (33 x 89 mm) and straight enough to provide a fence without noticeable misalignment.
 - b) If using hardwood, use posts that are 2 x 2 in (50 x 50 mm) with a minus tolerance of 1/4 in (6 mm) providing the cross sectional area is at least 3.28 in² (2120 mm²).
 - c) If using steel posts, use "U," "T," or "C" shaped posts with a minimum weight of 1.15 lb/ft (1.7 kg/m). Use posts that have projections for fastening the woven wire and filter fabric.

<p>NOTE: You must use woven wire or polypropylene mesh to provide extra support for Type "C" fence installations.</p>
--

3. Fasteners for Wooden Posts

- a. Wire Staples: Use staples that are at least 17 gauge (1.37 mm), legs at least 1/2 in (13 mm) long, and a crown at least 3/4 in (19 mm) wide.
- b. Nails: Use nails that are at least 14 gauge (2.03 mm), 1 in (25 mm) long, with button heads of at least 3/4 in (19 mm).

**DEPARTMENT OF TRANSPORTATION
STATE OF GEORGIA**

SPECIAL PROVISION

**Project Number: CSNHS-0008-00(415)
P.I. Number: 0008415
Fulton County**

Section 895—Polyacrylamide (PAM)

895.1 General Description

This section covers the use of anionic Polyacrylamide (PAM) as a flocculant on construction projects.

895.1.01 Related References

A. Standard Specifications

[Section 700—Grassing](#)

B. Referenced Documents

[QPL 84](#)

895.2 Materials

A. Requirements

Use only Polyacrylamide (PAM) products listed on the Qualified Products List ([QPL 84](#)).

Ensure Polyacrylamide (PAM) emulsions and powders are of the **anionic type only** and meet the following requirements:

1. Meets the EPA and FDA acrylamide monomer limits of equal to or greater than 0.05% acrylamide monomer.
2. Has a density of 10% to 55% by weight and a molecular weight of 16 to 24 Mg/mole.
3. Mixture is non-combustible.
4. Contains only manufacturer recommended additives.

B. Fabrication

General Provisions 101 through 150.

C. Acceptance

1. Polyacrylamide (PAM) products must meet the requirements of [Section 895](#) and be listed on [QPL 84](#).
2. Provide manufacturer's data on charge density and molecular weight.

D. Materials Warranty

General Provisions 101 through 150.

**DEPARTMENT OF TRANSPORTATION
STATE OF GEORGIA**

SPECIAL PROVISION

**Project Number: CSNHS-0008-00(415)
P.I. Number: 0008415
Fulton County**

Section 913—Reflectorizing Materials

Delete Section 913 and substitute the following:

913.1 General Description

This section includes the requirements for reflective sheeting.

913.1.01 Definitions

- Reflective Sheeting Types:
 - Type I: Medium-intensity retroreflective sheeting (engineering grade) that is typically an enclosed lens glass-bead retroreflective material.
 - Type II: Medium-high-intensity retroreflective sheeting (super engineering grade), that is typically enclosed lens glass-bead retroreflective material.
 - Type III: High-intensity retroreflective sheeting that is typically an encapsulated glass-bead retroreflective material.
 - Type IV: High-intensity retroreflective sheeting that is typically an unmetallized microprismatic retroreflective element material.
 - Type V: Super-high-intensity retroreflective sheeting that is typically a metallized microprismatic retroreflective element material. This material is typically used for delineators.
 - Type VI: Elastomeric high-intensity retroreflective sheeting without adhesive that is typically a vinyl microprismatic retroreflective material. This material is typically used for orange temporary roll up signs.
 - Type VII: Super-high-intensity retroreflective sheeting that is typically an unmetallized microprismatic retroreflective element material.
 - Type VIII: Super-high-intensity retroreflective sheeting that is typically an unmetallized microprismatic retroreflective element material.
 - Type IX: Very-high-intensity retroreflective sheeting that is typically an unmetallized microprismatic retroreflective element material.
 - Type X: Super-high intensity retroreflective sheeting that is typically an unmetallized microprismatic retroreflective element material.

913.1.02 Related References

A. Standard Specifications

General Provisions 101 through 150.

B. Referenced Documents

ASTM D 4956

[QPL 29](#)

913.2 Materials

913.2.01 Type I, II, III, IV, V, VI, VII, VIII, IX, and X Reflective Sheeting

A. Requirements

1. Use reflective sheeting that meets the requirements of ASTM D 4956.
2. Use reflective sheeting as listed in [QPL 29](#).
3. Use reflective sheeting that has been evaluated by the National Transportation Product Evaluation Panel (NTPEP) test facility or other approved test facility.
4. Submit the following to the Department:
 - a. A certificate with each lot or shipment stating the following:
 - The material supplied will meet all the test requirements listed herein.
 - You have performed the specified tests to ensure compliance.
 - You will submit test results upon request.

B. Fabrication

General Provisions 101 through 150.

C. Acceptance

1. The Engineer will reject reflective sheeting in the following situations:
 - a. The material fails to meet any one of the designated requirements.
 - b. The material meets the requirements but later fails during sign fabrication or in actual field use. Cracks, wrinkles, delamination, color change, or abnormal loss of reflectivity constitute failure.
 - c. Natural causes deteriorate the material to the extent that:
 - 1) The sign is ineffective for its intended purpose as defined in [Subsection 913.2.01.C.1.b](#) above.
 - 2) The average nighttime reflective brightness does not meet the outdoor weathering requirements of ASTM D4956.

D. Materials Warranty

Transfer to the Department a performance warranty for Type I, II, III, IV, V, VI, VII, VIII, IX, or X reflective sheeting issued by the manufacturer.

Ensure that the warranties cover the full replacement cost, including material and labor.

Include in these warranties a provision that the warranty is subject to a transfer to the Department.

Submit a warranty from the manufacturer that states that the reflective sheeting—processed, applied to sign blank materials, and cleaned—meets the outdoor weathering photometric requirements of ASTM D 4956.

**DEPARTMENT OF TRANSPORTATION
STATE OF GEORGIA**

Special Provision

**Project Number: CSNHS-0008-00(415)
P.I. Number: 0008415
Fulton County**

Section 917—Reflectors and Nonreflective Characters

Delete Subsection 917.1 and substitute the following:

917.1 General Description

This section includes the requirements of demountable characters with Type IX reflective sheeting, and direct-applied, nonreflective characters.

917.1.01 Related References

A. Standard Specifications

[Section 106—Certification of Materials](#)

[Section 913—Reflectorizing Materials](#)

B. Referenced Documents

ASTM B 209 (B 209M)

ASTM D 822

Delete Subsection 917.2.01 and substitute the following:

917.2.01 Demountable Characters with Type IX Reflective Sheeting

A. Requirements

1. Use Type IX reflective sheeting letters, numerals, symbols, and borders that meet the requirements of [Subsection 913.2.02](#), Type IX.
2. Use a silver color, unless otherwise specified on the Plans.
3. Apply the characters to aluminum flat frames as recommended by the sheeting manufacturer.
4. Use flat frames (letter, numerals, symbols and borders) made from aluminum sheet 0.032 in (0.813 mm) thick matching ASTM B 209 (209M), Alloy 3003-H14.
5. Submit to the Department:
 - One letter of a predominant size and type to be used on the Project.
 - A certificate to the Engineer stating that the material used on the Project is the same as the sample submitted.

B. Fabrication

1. Before applying any sheeting, properly degrease, etch, and treat each frame with a light, tight amorphous chromate-type coating.

2. Mechanically apply the reflective sheeting to the prepared flat aluminum frames. Use the proper equipment as prescribed by the sheeting manufacturer.
3. When recommended by the sheeting manufacturer, coat the completed demountable letters, numerals, symbols and borders with a clear finish approved by the sheeting manufacturer.
Apply the clear coat to the sheeting surface to ensure the sheeting has a fully glossy coat and a complete edge seal.
4. Ensure that the finished letters, numerals, symbols, and borders show careful workmanship, are clean cut, sharp, and have a plane surface.
5. Use the character size and shape to determine the hole spacing to mount the frame with aluminum rivets or other approved non-corrosive fasteners. Do not space holes more than 8 in (200 mm) on center.

C. Acceptance

The Department will accept the material based on test results of samples taken by the Department or of samples submitted by the manufacturer or fabricator, when directed. The sample shall consist of one letter of predominant size and type to be used on the Project. Samples submitted by the manufacturer or fabricator to the Engineer, shall include a certificate stating that the material used on the Project is the same as the sample submitted.

D. Materials Warranty

General Provisions 101 through 150.

Office of Materials and Research

**DEPARTMENT OF TRANSPORTATION
STATE OF GEORGIA**

SPECIAL PROVISION

Project Number: CSNHS-0008-00(415)

P.I. Number: 0008415

Fulton County

Section 919—Raised Pavement Markers

Delete Section 919 and Substitute the following:

919.1 General Description

This section includes the requirements for raised pavement marker materials for use in reflective, ceramic, and channel markers.

919.1.01 Related References

A. Standard Specifications

General Provisions 101 through 150.

B. Referenced Documents

ASTM C 424

ASTM C 373

ASTM D 2240

ASTM D 4280

Federal Method TT-T-141, Method 4252

919.2 Materials

A. Requirements

Do not use any marker materials until the laboratory approves it.

1. Use raised pavement marker sources as listed in [QPL 76](#).
2. Use raised pavement markers of the type shown in the Plans or specified in the proposal. This Specification references markers as follows:

Type	Description
1	One-way, one-color, 4 x 2 in (100 mm x 50 mm), reflective
2	Two-way, one-color, 4 x 2 in (100 mm x 50 mm), reflective
3	Two-way, two color, 4 x 2 in (100 mm x 50 mm), reflective
4	Round white, yellow or black ceramic, non reflective
5	Oval white, yellow or black ceramic, non-reflective

6	Oval white or yellow ceramic, reflective
7	White or yellow ceramic jiggle bar, non-reflective
8	White or yellow ceramic jiggle bar, reflective
9	White or yellow channel, non-reflective
10	White or yellow channel, reflective
11	Two-way, one-color, 4 x 4 in (100 mm x 100 mm), reflective
12	One-way, one color, 4 x 4 in (100 mm x 100 mm), reflective
13	Two-way, two color, 4 x 4 in (100 mm x 100 mm), reflective
14	Two-way, one color, flexible reflective
15	One-way, one color, flexible reflective

3. Certification

Submit a certification to the Engineer from the manufacturer showing the physical properties of the markers and their conformance to this Specification.

4. Packaging

Pack shipments in containers that are acceptable to common carriers.

- a. Pack the containers to ensure delivery in perfect condition.
- b. Clearly mark each package of pavement markers with the size, color, type, and lot number.
- c. You are liable to replace any damaged shipments.

919.2.01 Raised Retro-Reflective Pavement Markers (Type 1, 2, 3, 11, 12, and 13)

A. Requirements

1. Use raised retro-reflective pavement makers that meets the requirements of ASTM D 4280, designation H.
2. Use raised retro-reflective pavement makers as listed in QPL 76.
3. Use raised retro reflective pavement makers that have been evaluated by the National Transportation Product Evaluation Panel (NTPEP) test facility or other approved test facility.

B. Fabrication

General Provisions 101 through 150

C. Acceptance

The Department will give conditional approval to retro reflective pavement markers evaluated by the National Transportation Product Evaluation Program (NTPEP), the Georgia Department of Transportation, or other Department-approved test facilities and place them on QPL 76.

All white and yellow retro reflective pavement markers must meet the requirements of this Specification and the following field performance requirement.

- a. Conditional QPL Placement: The Department may add markers on a conditional basis to QPL 76. These markers must maintain an average coefficient of luminous intensity for 12 months of not less than 25% of the values shown in Table 1 of ASTM D 4280.
- b. Final Acceptance or Rejection: The Department will accept or reject markers based on the marker maintaining an average coefficient of luminous intensity of 0.2 cd/fc for 24 months.

919.2.02 Flexible Reflective Markers (Type 14 and 15)

A. Requirements

Use markers manufactured by extruding plastic into an “L” shape, with nominal dimensions of 4 in (100 mm) long x 2 in (50 mm) high (vertical face) x 1 in (25 mm) wide (base leg). Ensure that the markers have the following:

- A pressure-sensitive adhesive with a paper release liner to the bottom of the base leg.

- Strips of metallized acrylic reflective sheeting on either one or both sides of the vertical face.
- A clear plastic cover to protect the reflective strip. Ensure that the cover withstands a chip-seal operation and is easily removed after the operation.

1. Hardness

- Select five random markers
- Use ASTM D 2240 to determine the Shore A hardness
- The Department will reject markers whose body and clear protective cover hardness is less than 80.

B. Fabrication

General Provisions 101 through 150.

919.2.03 Ceramic Pavement Markers (Type 4, 5, 6, 7, and 8)

A. Requirements

- Use ceramic pavement markers made from a heat-fired, white, vitreous, ceramic base and a heat fired, opaque, glazed surface to produce the properties required in these Specifications.
 - Do not place glaze on the marker bottom where it connects to the road surface.
 - Thoroughly and evenly mature the markers. Ensure that they have no defects that affect appearance and serviceability.
 - Use reflective ceramic markers that meet the specific intensity of each reflective surface according to Table 1 of ASTM D 4280.
 - Ensure that the mean thickness of the glazed surface is at least 0.005 in (0.13 mm) when measured at least 0.25 in (6 mm) from the edge of the marker.
 - Ensure that the water absorption of the ceramic markers does not exceed 2 percent of the original dry weight when tested according to ASTM C 373.
 - Ensure that the glazed surface does not craze, spoil, or peel when passed through one cycle of the Autoclave test at 250 psi (1724 kPa) (ASTM C 424).
- Use the designated colors for the white and yellow markers.
 - Ensure that the colors are uniform.
 - Ensure that black matches Federal Color No. 595-27038.
 - Determine the color by visually comparing each marker with calibrated standards having CIE Chromaticity Coordinate limits. Determine the limits with Federal methods of test TT-T-141, Method 4252, using a rectangle with the following corner points:

	1		2		3		4		(90MGO)
White	.290	.316	.310	.296	.330	.320	.310	.344	80 min.
Yellow	.435	.485	.445	.435	.544	.456	.516	.484	50 min.

B. Fabrication

General Provisions 101 through 150.

C. Acceptance

- Use a random sample of five markers for lens impact strength, temperature cycling and compressive strength tests specified in ASTM D 4280.
- Use the following table to determine if the markers pass the tests.

Markers that Pass	Department Action
5 of 5	Accept the lot.
3 or less of 5	Reject the lot; no resample allowed.

4 of 5	The Contractor may request a retest. The Department will retest an additional 25 random markers in the test or tests where the original sample failed.
20 of 25 retested	Accept the lot.
19 or less of 25 retested	Reject the lot; no resample allowed.

3. Compressive Strength Test

- a. The markers pass if the average compressive load of all five markers is at least 1,500 psi (6.7 kN). No individual marker shall be less than 1,200 psi (5.3 kN).

D. Materials Warranty

General Provisions 101 through 150.

919.2.04 Channel Pavement Markers (Type 9 and 10)

A. Requirements

1. Use channel pavement markers made of either a heat-fired, white, vitreous, ceramic base with a heat-fired, opaque, glazed surface, or a 9 gauge (3.9 mm) steel body with a heat-fired porcelain finish.
 - a. Ensure both ceramic and steel channel markers have no defects that affect appearance and serviceability.
 - b. Ensure that the mean thickness of the glazed surface of ceramic channel markers is at least 0.005 in (0.13 mm) when measured at least 0.25 in (6 mm) from the edge of the marker.
 - c. Ensure that mean thickness of the porcelain finish on the steel channel markers is at least 0.030 in (0.76 mm).
 - d. Ensure that the water absorption of the ceramic markers does not exceed 2.0 percent of the original dry weight when tested according to ASTM C 373.
 - e. Ensure that the surface of the markers do not craze, spoil, or peel when passed through one cycle of the Autoclave test at 250 psi (1724 kPa) (ASTM C 424).
2. Use the designated colors for the white and yellow markers.
 - a. Ensure that the colors are uniform.
 - b. Determine the color by visually comparing them with calibrated standards having CIE Chromaticity Coordinate limits. Determine the limits with Federal methods of test TT-T-141, Method 4252, using a rectangle with the following corner points:

	1		2		3		4		(90MGO)
White	.290	.316	.310	.296	.330	.320	.310	.344	80 min.
Yellow	.435	.485	.445	.435	.544	.456	.516	.484	50 min.

B. Fabrication

General Provisions 101 through 150.

C. Acceptance

1. Ensure that Type 10 markers meet the specific intensity of each reflective surface according to Table 1 in ASTM D 4280.
2. Use a random sample of five markers for lens impact strength, temperature cycling and compressive strength tests specified in ASTM D 4280.
3. Select two of the five markers and subject them to all the required tests.
4. Use the following table to determine if the markers pass the tests.

Markers that Pass	Department Action
2 of 2	Accept the lot.
0 of 2	Reject the lot; no resample allowed.

1 of 2	Retest the three remaining markers.
3 of 3 retested	Accept the lot.
2 or less of 3 retested	Reject the lot; no resample allowed

D. Materials Warranty

General Provisions 101 through 150.

**DEPARTMENT OF TRANSPORTATION
STATE OF GEORGIA**

SPECIAL PROVISION

Section 925—Traffic Signal Equipment

Add the following to Subsection 925.1.01.B:

- ASTM D2444 Standard Test Methods for Determination of the Impact Resistance of Thermoplastic Pipe and Fittings by Means of a Tup
- ASTM D543 Standard Practices for Evaluating the Resistance of Plastics to Chemical Reagents

Add the following to Subsection 925.2.15.A.1:

Provide LED modules that are pixelated (5mm) for all circular indications, arrow indications, and hand and person pedestrian displays.

Delete Subsection 925.2.19.A and substitute the following:

925.2.19 Pedestrian Push Button Station

A. Requirements

Ensure that Pedestrian push buttons are of tamperproof construction and consist of a direct push type button and single momentary contact switch in cast aluminum housing. The pushbutton cover shall also be of cast aluminum. The housing and cover shall be free of voids, pits, dents, molding sand excessive foundry grinding marks. Exterior surface shall be smooth and cosmetically acceptable, free of molding fins, cracks and other exterior blemishes.

Provide housing and cover with an alodine conversion coating so as to provide a proper base for paint adhesion. Finish the housing with baked enamel and paint the push button housing and Pedestrian heads highway yellow (unless otherwise specified by the Engineer).

The assembly shall be capable of being mounted to a flat or curved surface. Ensure the assembly includes the appropriate sign as shown in the Plan Details.

Ensure that any screws or bolts are stainless steel. Provide the unit with a 0.5 inch (13 mm) threaded opening with plug.

Ensure that the assembly is weatherproof and so constructed that when properly installed, it will be impossible to receive an electrical shock under any weather condition.

Ensure that Pedestrian Pushbuttons are integrated with a sign as shown in the standard details. Provide the size sign as indicated on the Plans.

Ensure the button assembly is configured to have an embossed arrow on the convex surface of the button. The arrow shall be capable of rotating for proper movement direction. Ensure the rotation of the button will not affect the successful operation of the pedestrian detection.

Delete Subsection 925.2.34.A and substitute the following:

925.2.34 Prefabricated Controller Cabinet Base

A. Requirements

Provide controller cabinet bases that are precast polymer concrete and grey in color. Ensure the prefabricated controller cabinet base has the correct bolt pattern for the cabinet(s) to be installed. Provide prefabricated controller cabinet bases with UNC inserts as shown on plans. UNC inserts shall be stainless steel and be designed for a minimum of 15 foot-pounds of torque.

Ensure that prefabricated controller cabinet bases are designed to withstand wind loading of 125 mph (200 km/h) with the cabinets as shown in the Plans mounted. Ensure that prefabricated controller cabinet bases are designed for a minimum static vertical load of 5,000 pounds over a 10 inch by 10 inch by 1 inch thick distribution plate and withstand a tested load of 7,500 pounds. Ensure that prefabricated controller cabinet bases are designed for a minimum lateral load of 1800 pounds over an 18 inch by 24 inch by 1 inch steel plate applied to the longest side and shall withstand a tested load of 2700 pounds. The prefabricated controller cabinet base shall withstand a 50 foot-pound impact administered with a 12-pound weight having a “C” tup without puncture or splitting, in accordance with ASTM D2444. The prefabricated controller cabinet base shall meet the requirement of ASTM D543 Section 7, Procedure 1. Provide a copy of all test reports from a certified lab along with the materials certification package.

**DEPARTMENT OF TRANSPORTATION
STATE OF GEORGIA**

SPECIAL PROVISION

Project Number: CSNHS-0008-00(415)

P.I. Number: 0008415

Fulton County

**Section 934—Rapid Setting Patching Materials for Portland Cement
Concrete**

Delete Section 934 and substitute the following:

934.1 General Description

This section includes the requirements for rapid setting patching materials used in Portland cement concrete.

934.1.01 Related References

A. Standard Specifications

[Section 886—Epoxy Resin Adhesives](#)

B. Referenced Documents

AASHTO	ASTM
T 97 T 260	C 31/C31M C 109/C 109M C 140 C 666

Federal Hazardous Products Labeling Act

[QPL 27](#)

934.2 Materials

934.2.01 Rapid Setting Patching Materials

A. Requirements

1. Use rapid setting patching materials that have the following characteristics:
 - Are nonmetallic.
 - Have a color similar to Portland cement concrete.
 - Can be mixed and placed like concrete.
 - Have accelerated hardening characteristics.
 - Yield a permanent patch in concrete that can withstand traffic within 2 hours.

For a list of sources, see [QPL-27](#).

2. Type I

Use Type I to patch reinforced or nonreinforced horizontal Portland cement concrete surfaces.

Georgia Department of Transportation

State of Georgia

Special Provision

PROJECT NO.: CSNHS-0008-00(415), FULTON COUNTY

P.I. NO.: 0008415

Section 865—Manufacture of Prestressed Concrete Bridge Members

Delete Subsection 865.1 and substitute the following:

This section includes the following requirements for precast-prestressed concrete bridge members and piling using High Performance Portland cement concrete as shown in the Plans:

- Manufacturing
- Inspecting
- Testing
- Marking
- Painting
- Rubbing as specified
- Plant handling
- Storing
- Shipping

The term “precast-prestressed concrete” is referred to as “prestressed concrete” in the rest of this Section.

Add the following to Subsection 865.2:

Material	Section
Concrete, Class AAA HPC	500

Add the following to the end of Subsection 865.2.01.B.7.a.6:

Optional Method of Curing for Release Strengths with HPC: Temperature match curing (“Sure Cure” or equivalent methods) is allowed for specimens used to determine when stress may be transferred to the concrete for High Performance Concrete Units.

3. Type II
Use Type II to patch only nonreinforced horizontal Portland cement concrete surfaces.
4. Type III
Use Type III to patch reinforced vertical or overhead Portland cement concrete surfaces.
5. Classify Type I, Type II, and Type III as follows:
 - a. Class A, Premixed: Use these materials as received by adding water or an activator solution, according to the manufacturer's instructions.

NOTE: DO NOT add extra aggregate to Class A patching material without approval from the Office of Materials and Research.

- b. Class B, Non-Premixed: These materials contain no aggregate. Add aggregate (fine and/or coarse) according to the manufacturer's recommendations.
6. Type IV
Use elastomeric patching material to patch nonreinforced horizontal Portland cement concrete surfaces.
7. Type V
Use two-component cross linked resins to patch nonreinforced horizontal Portland cement concrete surfaces.
8. Type VI
Use cementitious, rapid setting, structural repair mortar to patch nonreinforced horizontal Portland cement concrete surfaces.
9. Physical Requirements
Ensure that Type I, Type II, and Type III rapid setting patching materials meet these requirements when tested with the required test methods.

Requirement	Measurement
Flow of Mortar, Type I and Type II Type III	100% minimum 80% to 100%
Flexural Strength, Minimum	500 psi (3.5 MPa) in 24 hours
Compression Strength, Minimum	
2 hours	1,200 psi (8.5 MPa)
24 hours	3,000 psi (20 MPa)
7 days (moisture cure)	4,000 psi (27.5 MPa)
Absorption, Maximum	10%
Shear Bond, Minimum	200 psi (1.5 MPa) in 24 hours
Freeze Thaw Durability Factor	75% of the reference concrete after 300 freeze-thaw cycles
Total Chlorides	
Type I and Type III	0.6 lb/yd ³ (0.4 kg/m ³) maximum
Type II	No limits

10. Submittals
For the Freeze-Thaw test, submit to the Department a certification from the manufacturer showing results of durability tests conducted by an independent professional testing laboratory.
Conduct the tests according to ASTM C 666. Express the durability as a durability factor.

B. Fabrication

1. Packaging

- a. Package this material in strong, moisture-proof paper bags or other suitable containers that can withstand shipping, normal handling, and storage without breaking.
- b. Clearly label each container of the components of a patching system with the following information:
 - Component designation, if two components.
 - Manufacturer’s batch number.
 - Mixing ratio and directions.
 - Potential hazards and precautions displayed according to the Federal Hazardous Products Labeling Act.

C. Acceptance

1. Follow the mixing instructions of the manufacturer to create test specimens.
2. Air-cure all test specimens except for the 7-day moisture cure cubes.
3. Test Types I, II, and III using the following methods:

Test	Method
Flow of mortar	ASTM C 230
Flexural strength	AASHTO T 97
Compressive strength	ASTM C 109/C 109M or C 31/C 31M, whichever is applicable
Absorption	ASTM C 140
Shear bond strength	See Subsection 934.2.01.C , “Acceptance”, Step 4
Rapid freeze thaw	ASTM C 666
Total chlorides	AASHTO T 260

4. Shear Bond Strength
 - a. Place a Type II epoxy resin adhesive meeting the requirements of [Section 886](#) on the surface of a cured mortar bar 16 x 3 x 3 in (400 x 75 x 75 mm).
 - b. Cast a 16 x 2 x 0.5 in (400 x 50 x 13 mm) rapid-setting material patch in the center of the mortar base.
 - c. Air-cure the test sample for 24 hours.
 - d. Saw the mortar bar base and the cured rapid setting material patch into 2 in (50 mm) segments for testing.
 - e. Use a holding device and plunger to apply a load at a rate of 0.05 in (1.3 mm) per minute to the patch until the patch fails.
 - f. Read the load in pounds (newtons) on the plunger.
 - g. Calculate the shear bond strength in pounds per square inch by dividing the load in pounds by the interfacial area of the patch in square inches. Calculate the metric equivalent for shear bond strength in MPa by dividing the load in newtons by gravitational acceleration (9.81 m/s²).
5. The Department will conduct one year field evaluations for each Type IV, Type V and Type VI patching material.
6. The Department will reject a patching system that meets all the requirements of this Specification, but does not work as required in actual use.

D. Materials Warranty

Ensure that the material has a minimum storage life of at least 1 year under conditions of 40° to 90° F (4° to 32° C) and maximum relative humidity of 90 percent.

**DEPARTMENT OF TRANSPORTATION
STATE OF GEORGIA**

**Project Number: CSNHS-0008-00(415)
P.I. Number: 0008415
Fulton County**

SPECIAL PROVISION

Add the following:

ESCROW BID DOCUMENTATION

Scope and Purpose

The purpose of this specification is to preserve the bid documents of the successful bidder (Contractor) for use by the parties in any claims or litigation between the Department and Contractor arising out of this contract.

The Contractor shall submit a legible copy of bid documentation used to prepare the bid for this contract to the Department. Such documentation shall be placed in escrow with a banking institution or other bonded document storage facility and preserved by that institution/facility as specified in the following sections of this specification.

Bid Documentation

The term "bid documentation" as used in this specification means all writings, working papers, computer printouts, charts, and all other data compilations which contain or reflect information, data, and calculations used by the Contractor to determine the bid in bidding for this project. The term "bid documentation" includes, but is not limited to, Contractor equipment rates, Contractor overhead rates, labor rates, efficiency or productivity factors, arithmetic extensions, and quotations from subcontractors and material suppliers to the extent that such rates and quotations were used by the Contractor in formulating and determining the amount of the bid. The term "bid documentation" also includes any manuals which are standard to the industry used by the Contractor in determining the bid for this project. Such manuals may be included in the bid documentation by reference. Such reference shall include the name and date of the Publication and the Publisher. The term does not include bid documents provided by the Department for use by the Contractor in bidding on this project.

Submittal of Bid Documentation

The Contractor shall submit the bid documentation to the Department in a container suitable for sealing, no later than ten calendar days following award of the Contract by the Department. The Department will not issue a Notice to Proceed until the acceptable documentation has been received. The container shall be clearly marked "Bid Documentation" and shall also show on the face of the container the Contractor's name, the date of submittal, the Project Number, the P.I. Number, the Contract Number, and the County.

Affidavit

In addition to the bid documentation, an affidavit, signed under oath by an individual authorized by the Contractor to execute bidding proposals shall be included. The affidavit shall list each bid document with sufficient specificity so a comparison may be made between the list and the bid documentation to ensure that all of the bid documentation

listed in the affidavit has been enclosed. The affidavit shall attest that the affiant has personally examined the bid documentation, that the affidavit lists all of the documents used by the Contractor to determine the bid for this project, and that all such bid documentation has been included.

Verification

Upon receipt of the bid documentation authorized representatives of the Department and the Contractor will verify the accuracy and completeness of the bid documentation compared to the affidavit. Should a discrepancy exist the Contractor shall immediately furnish the Department with any other needed total documentation. The Department, upon determining that the bid documentation is complete, will, in the presence of the Contractor's representative, immediately place the complete documentation and affidavit in the container and seal it. Both parties will deliver the sealed container to a banking institution or other bonded document storage facility selected by the Department for placement in a safety deposit box, vault or other secure accommodation.

Duration and Use

The bid documentation and affidavit shall remain in escrow during the life of the Contract or until such time as the Contractor notifies the Department of his intention to file a claim or his initiation of litigation against the Department related to the Contract. Notification of the Contractor's intention to file a claim or litigation against the Department shall be sufficient evidence for the Department to obtain the release and custody of the bid documentation. If no such notification is received and the Contractor has signed the final Standard Release Form the Department shall instruct the banking institution or other bonded document storage facility to release the sealed container to the Contractor.

The Contractor agrees that the sealed container placed in escrow contains all of the bid documentation used to determine the bid and that no other bid documentation shall be utilized by the Contractor in litigation over claims brought by the Contractor arising out of this contract.

Refusal or Failure to Provide Bid Documentation

Failure or refusal to provide bid documentation shall be deemed either:

1. Failure to execute the Contract if the Contract has not yet been executed or,
2. Material breach of the Contract if the Contract has been executed.

Should the Contractor fail to execute the Contract as stated in 1 above, the Department will retain the bid bond. Refusal of the Contractor to provide adequate documentation after execution of the Contract will be considered material breach of the Contract and the Contractor will be declared in default of the Contract. The Department may, at its option terminate the contract for default. These remedies are not exclusive and the Department may take such other action as is available to it under the law.

Confidentiality of Bid Documentation

The bid documentation and affidavit in escrow are, and will remain, the property of the Contractor. The Department has no interest in, or right to, the bid documentation and affidavit other than to verify the contents and legibility of the bid documentation unless notification of the intention to file claim is received or litigation ensues between the Department and Contractor. In the event of such notification or litigation, the bid documentation and affidavit shall become the property of the Department.

Cost and Escrow Instructions

The cost of the escrow will be borne by the Department. The Department will provide escrow instructions to the banking institution or other bonded document storage facility consistent with this specification.

Escrow Agreement

A copy of the Escrow Agreement the successful bidder will be required to sign is attached. The successful bidder (contractor) agrees that they will sign the Escrow Agreement. Should the Contractor fail to sign the Escrow Agreement, when presented, the Department will retain the bid bond. If the Contract has been executed, and the Contractor fails to sign the Escrow Agreement, the Contractor may be declared in default of the Contract.

Payment

There will be no separate payment for compilation of the data, container or cost of verification of the bid documentation. All costs shall be included in the overall Contract bid price.

**Escrow Agreement
For
Bid Documents**

THIS AGREEMENT is made and entered into this _____ day of _____, 20____, by and among the Department of Transportation, an agency of the State of Georgia, hereinafter called the "DEPARTMENT"; _____; hereinafter called the "CONTRACTOR"; and _____, hereinafter called the "ESCROW AGENT".

WHEREAS, the DEPARTMENT awarded a project on _____, 20__, based on a bid proposal submitted by the CONTRACTOR, hereinafter called the "PROPOSAL", for the construction of Project Number _____ County(ies), Georgia, hereinafter called the "PROJECT", pursuant to which the CONTRACTOR shall cause the work therein to be constructed; and

WHEREAS, the DEPARTMENT and CONTRACTOR are desirous of entering into an Escrow Agreement, to provide for specific contingencies governing the escrow and control of the PROPOSAL bid documentation; hereinafter called "BID DOCUMENTS"; and

WHEREAS, the DEPARTMENT and CONTRACTOR desire the ESCROW AGENT to hold the BID DOCUMENTS of the CONTRACTOR;

NOW THEREFORE, for and in consideration of the mutual covenants contained herein, it is agreed by and between the parties hereto that:

**ARTICLE I
ESCROW BID DOCUMENTATION**

The parties hereto agree to the establishment of Escrow of the BID DOCUMENTS for the PROPOSAL pursuant to the Specifications, Supplemental Specifications, or Special Provisions pertaining to construction under the contract. It is the understanding of the parties hereto that the DEPARTMENT shall pay the ESCROW AGENT, as determined by separate agreement, for the escrow of the BID DOCUMENTS submitted to the ESCROW AGENT under the terms of this Agreement.

ARTICLE II

ACKNOWLEDGMENT

By its signature below, the ESCROW AGENT hereby acknowledges receipt from the DEPARTMENT and CONTRACTOR of a sealed container bearing the CONTRACTOR'S name, address and PROJECT Number assigned by the DEPARTMENT and containing, as specified by the affidavit of the CONTRACTOR, the PROPOSAL BID DOCUMENTS for the aforementioned PROJECT.

ARTICLE III DEPOSIT OF BID DOCUMENTS

The PROPOSAL BID DOCUMENTS shall remain on deposit with the ESCROW AGENT until those conditions of release, as specified in ARTICLE IV, RELEASE FROM ESCROW, are met. As long as the BID DOCUMENTS remain in escrow with the ESCROW AGENT, the ESCROW AGENT shall not allow any person access, to gain possession, or to in any way interfere with the sealed BID DOCUMENT container.

ARTICLE IV RELEASE FROM ESCROW

Upon being presented, by the DEPARTMENT, with a CONTRACTOR signed final Standard Release Form for the contract for the PROJECT, the ESCROW AGENT shall deliver to the CONTRACTOR the sealed container bearing the CONTRACTOR'S name and address and project number on it. The ESCROW AGENT is also authorized to release the BID DOCUMENT sealed container to the DEPARTMENT without the CONTRACTOR'S signed consent subject to the following conditions:

1. The CONTRACTOR has provided written notification to the DEPARTMENT of the CONTRACTOR'S intention to file a claim related to the contract for the PROJECT; or
2. The CONTRACTOR has initiated litigation against the DEPARTMENT relating to the contract for the PROJECT.

Prior to any release from escrow to the DEPARTMENT the ESCROW AGENT shall verify that either condition of release to the DEPARTMENT, as stated above, has been met by providing written notice to the CONTRACTOR of the ESCROW AGENT'S intention to release the PROPOSAL BID DOCUMENTS to the DEPARTMENT. Such written notice from the ESCROW AGENT shall be sent by certified mail no less than ten (10) calendar days prior to release to the DEPARTMENT. Upon any release from escrow of the PROPOSAL BID DOCUMENT container the ESCROW AGENT shall cause the execution of Exhibit A, Escrow Release for

PROPOSAL BID DOCUMENTS, as attached hereto and incorporated herein as if fully contained, by the party receiving the BID DOCUMENT container.

**ARTICLE V
INDEMNITY**

The CONTRACTOR agrees to indemnify and hold the ESCROW AGENT harmless against any loss, claim, damage, liability or expenses incurred in connection with any action, suit, proceeding, claim or alleged liability arising from this Escrow Agreement, provided, however, that the ESCROW AGENT shall not be so indemnified or held harmless for its negligence or acts of bad faith by it or any of its agents or employees.

ARTICLE VI NOTICES

All notices and other communication shall be in writing and shall be deemed to have been duly given and delivered if mailed by certified mail, return receipt requested, postage prepaid to the addresses stated herein:

DEPARTMENT:

Georgia Department of Transportation

ATTN: Treasurer

600 West Peachtree Street

Atlanta, Georgia 30308

CONTRACTOR:

ESCROW AGENT:

ARTICLE VII DUTIES OF ESCROW AGENT

The duties and responsibilities of the ESCROW AGENT shall be limited to those expressly set forth herein and the ESCROW AGENT shall act only in accordance with this ESCROW Agreement.

Notwithstanding specific provisions hereunder, the ESCROW AGENT shall at all times act upon and in accordance with the joint written instructions of the DEPARTMENT and CONTRACTOR.

**ARTICLE VIII.
LAWS**

This Escrow Agreement shall be deemed to have been executed in Fulton County, Georgia and the laws of the State of Georgia shall apply.

**ARTICLE IX
ASSIGNMENT**

This Escrow Agreement shall not be assigned without the written consent of all the parties hereto.

**ARTICLE X
SURVIVAL OF CONTRACT**

Except as may be expressly modified, all terms and conditions of this Escrow Agreement remain in full force and effect. The establishment of this Escrow Agreement is limited solely by the contingency of release of the PROPOSAL BID DOCUMENTS by the CONTRACTOR to the DEPARTMENT, as established by Article IV, Release From Escrow. Nothing contained herein shall alter the rights of the parties hereto.

The covenants herein contained shall, except as otherwise provided, accrue to the benefit of and be binding upon the successors and assigns of the parties hereto.

IN WITNESS WHEREOF, the parties hereunto set their hands and seals the day above first
written.

CONTRACTOR:
BY:

(SEAL)

TITLE:

WITNESS

ESCROW AGENT:
BY:

(SEAL)

TITLE:

WITNESS

DEPARTMENT OF TRANSPORTATION
BY:

TITLE: STATE TRANSPORTATION OFFICE ENGINEER

WITNESS

ESCROW CONTAINER SEAL NUMBERS:

**Exhibit A
ESCROW RELEASE
OF
BID DOCUMENTS**

This is to certify that on this _____ day of _____, 20____, the sealed container identified as:

“Bid Documentation”

CONTRACTOR:

PROJECT NUMBER:

P.I. NUMBER:

CONTRACT NUMBER:

DATE OF SUBMITTAL:

(Evidence by Agreement dated _____).

was released from escrow and personally handed to the below named individual acknowledging receipt, representing the CONTRACTOR/DEPARTMENT, by the ESCROW AGENT upon the presentation of the required documentation pursuant to Article IV, Release from Escrow, of the agreement dated _____, 20__, a copy of such documentation is attached hereto.

Acknowledgment of Receipt:

Acknowledgment of Release:

ESCROW AGENT

ESCROW CONTAINER SEAL NUMBERS:

AFFIDAVIT

STATE OF GEORGIA

COUNTY OF FULTON

COMES NOW _____ (Name) _____, _____ (Title) _____
of _____ (Company Name) _____ who, after having been duly sworn,
on oath, state and depose as follows:

1.

This Affidavit is based upon the personal knowledge of the Affiant.

2.

_____ (Company Name) _____ submitted a bid on Georgia Department of
Transportation Project _____, _____ COUNTY(IES) which bid was
the low, responsive bid, and a Contract has been entered into between _____ (Company Name) _____ and the Georgia
Department of Transportation, known as Contract No. B-_____.

3.

This Affidavit is given in compliance with the special provision entitled "ESCROW BID
DOCUMENTATION" forming part of the Contract Documents of Contract No. B-_____.

4.

The Affiant attests that, in his capacity for _____ (Company Name) _____, he is personally
aware the "Bid Documentation" which was used by the Company in determining, formulating, and submitting the
bid on Project No. _____, _____ COUNTY(IES).

5.

The Affiant further states that he has examined the bid documentation which has been placed in a sealed
container marked "Bid Documentation", and that all such Bid Documentation utilized by the Company in
determining, formulating, and submitting its bid is contained in the sealed container so marked.

6.

Each bid document contained in the sealed container is separately listed on Exhibit A, which is attached
hereto and incorporated herein as fully as if included in this Affidavit at this paragraph 6.

Further Affiant sayeth not.

(Company Name)

By: _____

(Name)

Its: _____
(Title)

Sworn to and subscribed before me this _____ day of _____, 20_____.

NOTARY PUBLIC

My Commission expires: _____

Georgia DOT Project: CSNHS-0008-00(415) Fulton County
GDOT P.I. 0008415

MEMORANDUM OF UNDERSTANDING

between the
Georgia Department of Transportation (hereafter the DEPARTMENT)
and
ATLANTA Gas LIGHTS (hereafter the OWNER)

Whereas the DEPARTMENT proposes to undertake a design-build project to reconstruct a new bridge at Hammond Drive over Georgia 400 in Fulton County, Georgia by contract through competitive bidding procedures; and,

Whereas the DEPARTMENT will accomplish the design-build project through a Design Consultant, Design Consultant Team and/or Contractor hereafter referred to as CONTRACTOR; and,

Whereas the OWNER has the following utility facilities which may need to be adjusted or relocated as a result of the proposed contract:

Type of facility or facilities of the OWNER:

- Domestic water mains and distribution lines and associated appurtenances.
- Sanitary Sewer facilities and/or Storm Drainage System
- Electrical Distribution (overhead and underground) wires, poles, etc.
- Electrical Transmission (overhead and underground) wires, poles, etc.
- Natural Gas Distribution Facilities (underground)
- Telecommunications facilities and equipment
- Cable TV facilities.
- Street Lighting
- Internet Data Service

Whereas the OWNER desires the following to be installed as new additional facilities during the proposed contract.

Insert detailed description of proposed new additional utility installations:

Design Responsibilities for adjusted, relocated, and new additional utility facilities:

____(1a) Whereas the OWNER does not have adequate staff to perform the design functions for the adjustment or relocation of its facilities and is willing to have this design work included in the contract to be let by the DEPARTMENT.

____(2a) Whereas the OWNER is willing to have this design work included in the contract to be let by the DEPARTMENT.

(3a) Whereas the OWNER will perform its own relocation or adjustment design.

If method (1a) or (2a) for the adjustment, relocation or installation of new facilities is selected, all design necessary for the adjustment or relocation of the described utilities in accordance with the plans when approved shall be included in the project contract and accomplished by the CONTRACTOR except as follows (check none or list any work items to be performed by the OWNER):

____ None.

Excluded Items: _____.

Construction Responsibilities for adjusted, relocated, and new additional utility facilities:

____(1b) Whereas the OWNER does not have adequate equipment and staff to adjust its facilities and is willing to have this work included in the contract to be let by the DEPARTMENT.

____(2b) Whereas the OWNER is willing to have this work included in the contract to be let by the DEPARTMENT.

(3b) Whereas the OWNER will perform its own relocations or adjustments.

If method (1b) or (2b) for the adjustment, relocation or installation of new facilities is selected, all work necessary for the adjustment or relocation of the described utilities in accordance with the plans when approved shall be included in the project contract and accomplished by the CONTRACTOR except as follows (check none or list any work items to be performed by the OWNER):

____ None.

Excluded Items: _____.

The following is hereby mutually agreed to and understood by both parties:

1. The identification of existing facilities including preparation of base maps plans will be accomplished by the DEPARTMENT prior to award of the project contract and thereafter supplemented by the CONTRACTOR.
2. The CONTRACTOR shall coordinate reviews of the information and obtain acceptance from the OWNER and DEPARTMENT when required. However; the OWNER shall apply for and obtain any required permits from the DEPARTMENT and perform any final design or proprietary design needed to administer its own relocation work if the work will not be included in the project contract (list any work not included in the project in space provided above). If the preliminary plans indicate that no conflict exists, and the OWNER accepts this information, the OWNER shall provide a letter of "no conflict" to the CONTRACTOR.
3. The CONTRACTOR will research the property interest of each OWNER and present the findings to the DEPARTMENT and OWNER for approval. The CONTRACTOR will coordinate resolution of any disputed items. The plans and estimate for the utility work shall be subject to approval of both the DEPARTMENT and the OWNER prior to construction. If the OWNER chooses to include the subject utility work in the project construction and the research indicates that no property interest exists, and the OWNER cannot refute this finding with evidence that would substantiate the property interest in legal proceedings, the OWNER shall provide confirmation in writing that OWNER will reimburse the DEPARTMENT for any adjustment or relocations necessary; and an agreement will be prepared and executed in accordance with the DEPARTMENT'S "Utility Accommodation Policy and Standards Manual". If the OWNER chooses to perform it own relocations and the OWNER holds no property interest as stated above; the OWNER shall confirm in writing that the OWNER will relocate its own facilities at no cost to the DEPARTMENT and the CONTRACTOR.
4. All construction engineering and contract supervision shall be the responsibility of the DEPARTMENT and the CONTRACTOR to assure that all utility work included in the project contract is accomplished in accordance with plans and specifications and to consult with the OWNER before authorizing any changes or deviations which affect the OWNER's facility.
5. For Utility work included in the contract, the OWNER or the OWNER's Consultant shall have the right to visit and inspect the work at any time and advise the CONTRACTOR and the DEPARTMENT'S Engineer of any observed discrepancies or potential problems. The DEPARTMENT agrees to notify the OWNER when all utility work is completed and ready for final inspection by the OWNER.
6. Upon completion of the utility work included in the contract and upon certification by the DEPARTMENT'S Engineer that the work has been completed in accordance with the plans and specifications, the OWNER will accept the adjusted, relocated, and additional facilities and will thereafter operate and maintain said facilities located within public right of way subject to the DEPARTMENT'S "Utility Accommodation Policy and Standards, 1988 edition" and any agreements in effect without further cost to the DEPARTMENT or it's CONTRACTOR.
7. For the purpose of utility coordination, relocation and reimbursement matters, the OWNER shall cooperate with the CONTRACTOR in the same manner as if directly with the DEPARTMENT in accordance with the laws of Georgia, the DEPARTMENT'S "Utility Accommodation Policy and Standards, 1988 edition" and any agreements in effect between the DEPARTMENT and OWNER. The OWNER agrees to cooperate in good faith with the CONTRACTOR and to respond to all requests for information or meetings required to reach a resolution of any disputed items.

The Memorandum of Understanding will be incorporated into the project contract by reference or Exhibit.

APPROVED FOR THE OWNER BY:

(Signature)

3-4-08
(Date)

MANAGER, ENGINEERING DESIGN
(Title)

APPROVED FOR THE DEPARTMENT BY:

(Signature)

3-6-2008
(Date)

STATE UTILITIES ENGINEER

Georgia DOT Project: P I No 0008415 - Hammond Drive Interchange Design Build
 Project Fulton County
 GDOT P.I. 0008415

MEMORANDUM OF UNDERSTANDING

between the
 Georgia Department of Transportation (hereafter the DEPARTMENT)
 AT&T (hereafter the OWNER)

Whereas the DEPARTMENT will accomplish the design-build project through a Design Consultant, Design Consultant Team and/or Contractor hereafter referred to as CONTRACTOR; and,

Whereas the OWNER has the following utility facilities which may need to be adjusted or relocated as a result of the proposed contract:

Type of facility or facilities of the OWNER:

- Domestic water mains and distribution lines and associated appurtenances.
- Sanitary Sewer facilities and/or Storm Drainage System
- Electrical Distribution (overhead and underground) wires, poles, etc.
- Electrical Transmission (overhead and underground) wires, poles, etc.
- Natural Gas Distribution Facilities (underground)
- Telecommunications facilities and equipment
- Cable TV facilities.
- Street Lighting
- Internet Data Service

Whereas the OWNER desires the following to be installed as new additional facilities during the proposed contract.

Insert detailed description of proposed new additional utility installations:

AT&T has a 6-way duct bank crossing SR 400 on the northside of the existing bridge. This ductbank contains 4 fiber optic cables totaling 660 strands of fiber. These cables contain major backbone network elements including interoffice trunk lines between Sandy Springs and Dunwoody, diversity routes and ring configurations for large corporations, and other special circuits that are dedicated to customers for reliability. We will require space on the new bridge in order to place a new ductbank to relocate these cables out of the existing bridge before it can be removed.

Design Responsibilities for adjusted, relocated, and new additional utility facilities:

___(1a) Whereas the OWNER does not have adequate staff to perform the design functions for the adjustment or relocation of its facilities and is willing to have this design work included in the contract to be let by the DEPARTMENT.

___(2a) Whereas the OWNER is willing to have this design work included in the contract to be let by the DEPARTMENT:

X 3a) Whereas the OWNER will perform its own relocation or adjustment design.

If method (1a) or (2a) for the adjustment, relocation or installation of new facilities is selected, all design necessary for the adjustment or relocation of the described utilities in accordance with the plans when approved shall be included in the project contract and accomplished by the CONTRACTOR except as follows (check none or list any work items to be performed by the OWNER):

___ None.

Excluded
Items: _____

Construction Responsibilities for adjusted, relocated, and new additional utility facilities:

___(1b) Whereas the OWNER does not have adequate equipment and staff to adjust its facilities and is willing to have this work included in the contract to be let by the DEPARTMENT.

___(2b) Whereas the OWNER is willing to have this work included in the contract to be let by the DEPARTMENT.

X (3b) Whereas the OWNER will perform its own relocations or adjustments.

If method (1b) or (2b) for the adjustment, relocation or installation of new facilities is selected, all work necessary for the adjustment or relocation of the described utilities in accordance with the plans when approved shall be included in the project contract and accomplished by the CONTRACTOR except as follows (check none or list any work items to be performed by the OWNER):

___ None.

Excluded
Items: _____

The following is hereby mutually agreed to and understood by both parties:

1. The identification of existing facilities including preparation of base maps plans will be accomplished by the DEPARTMENT prior to award of the project contract and thereafter supplemented by the CONTRACTOR.
2. The CONTRACTOR shall coordinate reviews of the information and obtain acceptance from the OWNER and DEPARTMENT when required. However; the OWNER shall apply for and obtain any required permits from the DEPARTMENT and perform any final design or proprietary design needed to administer its own relocation work if the work will not be included in the project contract (list any work not included in the project in space provided above). If the preliminary plans indicate that no conflict exists, and the OWNER accepts this information, the OWNER shall provide a letter of "no conflict" to the CONTRACTOR.
3. The CONTRACTOR will research the property interest of each OWNER and present the findings to the DEPARTMENT and OWNER for approval. The CONTRACTOR will coordinate resolution of any disputed items. The plans and estimate for the utility work shall be subject to approval of both the DEPARTMENT and the OWNER prior to construction. If the OWNER chooses to include the subject utility work in the project construction and the research indicates that no property interest exists, and the OWNER cannot refute this finding with evidence that would substantiate the property interest in legal proceedings, the OWNER shall provide confirmation in writing that OWNER will reimburse the DEPARTMENT for any adjustment or relocations necessary; and an agreement will be prepared and executed in accordance with the DEPARTMENT'S "Utility Accommodation Policy and Standards Manual". If the OWNER chooses to perform it own relocations and the OWNER holds no property interest as stated above; the OWNER shall confirm in writing that the OWNER will relocate its own facilities at no cost to the DEPARTMENT and the CONTRACTOR.
4. All construction engineering and contract supervision shall be the responsibility of the DEPARTMENT and the CONTRACTOR to assure that all utility work included in the project contract is accomplished in accordance with plans and specifications and to consult with the OWNER before authorizing any changes or deviations which affect the OWNER's facility.
5. For Utility work included in the contract, the OWNER or the OWNER's Consultant shall have the right to visit and inspect the work at any time and advise the CONTRACTOR and the DEPARTMENT'S Engineer of any observed discrepancies or potential problems. The DEPARTMENT agrees to notify the OWNER when all utility work is completed and ready for final inspection by the OWNER.
6. Upon completion of the utility work included in the contract and upon certification by the DEPARTMENT'S Engineer that the work has been completed in accordance with the plans and specifications, the OWNER will accept the adjusted, relocated, and additional facilities and will thereafter operate and maintain said facilities located within public right of way subject to the DEPARTMENT'S "Utility Accommodation Policy and Standards, 1988

edition" and any agreements in effect without further cost to the DEPARTMENT or it's CONTRACTOR.

- 7. For the purpose of utility coordination, relocation and reimbursement matters, the OWNER shall cooperate with the CONTRACTOR in the same manner as if directly with the DEPARTMENT in accordance with the laws of Georgia, the DEPARTMENT'S "Utility Accommodation Policy and Standards, 1988 edition" and any agreements in effect between the DEPARTMENT and OWNER. The OWNER agrees to cooperate in good faith with the CONTRACTOR and to respond to all requests for information or meetings required to reach a resolution of any disputed items.

The Memorandum of Understanding will be incorporated into the project contract by reference or Exhibit.

APPROVED FOR THE OWNER BY:

David Wagoner
(Signature)

2-27-2008
(Date)

Specialist-OSP Facility Design
(Title)

APPROVED FOR THE DEPARTMENT BY:

(Signature)

3-6-2008
(Date)

STATE UTILITIES ENGINEER

Georgia DOT Project: CSNHS-0008-00(415) Fulton County
GDOT P.I. 0008415

MEMORANDUM OF UNDERSTANDING

between the
Georgia Department of Transportation (hereafter the DEPARTMENT)
and
City of Atlanta, Department of Watershed Management (hereafter the OWNER)

Whereas the DEPARTMENT proposes to undertake a design-build project to reconstruct a new bridge at Hammond Drive over Georgia 400 in Fulton County, Georgia by contract through competitive bidding procedures; and,

Whereas the DEPARTMENT will accomplish the design-build project through a Design Consultant, Design Consultant Team and/or Contractor hereafter referred to as CONTRACTOR; and,

Whereas the OWNER has the following utility facilities which may need to be adjusted or relocated as a result of the proposed contract:

Type of facility or facilities of the OWNER:

- Domestic water mains and distribution lines and associated appurtenances.
- Sanitary Sewer facilities and/or Storm Drainage System
- Electrical Distribution (overhead and underground) wires, poles, etc.
- Electrical Transmission (overhead and underground) wires, poles, etc.
- Natural Gas Distribution Facilities (underground)
- Telecommunications facilities and equipment
- Cable TV facilities.
- Street Lighting
- Internet Data Service

Whereas the OWNER desires the following to be installed as new additional facilities during the proposed contract.

Insert detailed description of proposed new additional utility installations:

Design Responsibilities for adjusted, relocated, and new additional utility facilities:

____(1a) Whereas the OWNER does not have adequate staff to perform the design functions for the adjustment or relocation of its facilities and is willing to have this design work included in the contract to be let by the DEPARTMENT.

____(2a) Whereas the OWNER is willing to have this design work included in the contract to be let by the DEPARTMENT.

(3a) Whereas the OWNER will perform its own relocation or adjustment design.

If method (1a) or (2a) for the adjustment, relocation or installation of new facilities is selected, all design necessary for the adjustment or relocation of the described utilities in accordance with the plans when approved shall be included in the project contract and accomplished by the CONTRACTOR except as follows (check none or list any work items to be performed by the OWNER):

None.

Excluded Items: _____.

Construction Responsibilities for adjusted, relocated, and new additional utility facilities:

____(1b) Whereas the OWNER does not have adequate equipment and staff to adjust its facilities and is willing to have this work included in the contract to be let by the DEPARTMENT.

____(2b) Whereas the OWNER is willing to have this work included in the contract to be let by the DEPARTMENT.

(3b) Whereas the OWNER will perform its own relocations or adjustments.

If method (1b) or (2b) for the adjustment, relocation or installation of new facilities is selected, all work necessary for the adjustment or relocation of the described utilities in accordance with the plans when approved shall be included in the project contract and accomplished by the CONTRACTOR except as follows (check none or list any work items to be performed by the OWNER):

None.

Excluded Items: _____.

The following is hereby mutually agreed to and understood by both parties:

1. The identification of existing facilities including preparation of base maps plans will be accomplished by the DEPARTMENT prior to award of the project contract and thereafter supplemented by the CONTRACTOR.
2. The CONTRACTOR shall coordinate reviews of the information and obtain acceptance from the OWNER and DEPARTMENT when required. However; the OWNER shall apply for and obtain any required permits from the DEPARTMENT and perform any final design or proprietary design needed to administer its own relocation work if the work will not be included in the project contract (list any work not included in the project in space provided above). If the preliminary plans indicate that no conflict exists, and the OWNER accepts this information, the OWNER shall provide a letter of "no conflict" to the CONTRACTOR.
3. The CONTRACTOR will research the property interest of each OWNER and present the findings to the DEPARTMENT and OWNER for approval. The CONTRACTOR will coordinate resolution of any disputed items. The plans and estimate for the utility work shall be subject to approval of both the DEPARTMENT and the OWNER prior to construction. If the OWNER chooses to include the subject utility work in the project construction and the research indicates that no property interest exists, and the OWNER cannot refute this finding with evidence that would substantiate the property interest in legal proceedings, the OWNER shall provide confirmation in writing that OWNER will reimburse the DEPARTMENT for any adjustment or relocations necessary; and an agreement will be prepared and executed in accordance with the DEPARTMENT'S "Utility Accommodation Policy and Standards Manual". If the OWNER chooses to perform it own relocations and the OWNER holds no property interest as stated above; the OWNER shall confirm in writing that the OWNER will relocate its own facilities at no cost to the DEPARTMENT and the CONTRACTOR.
4. All construction engineering and contract supervision shall be the responsibility of the DEPARTMENT and the CONTRACTOR to assure that all utility work included in the project contract is accomplished in accordance with plans and specifications and to consult with the OWNER before authorizing any changes or deviations which affect the OWNER's facility.
5. For Utility work included in the contract, the OWNER or the OWNER's Consultant shall have the right to visit and inspect the work at any time and advise the CONTRACTOR and the DEPARTMENT'S Engineer of any observed discrepancies or potential problems. The DEPARTMENT agrees to notify the OWNER when all utility work is completed and ready for final inspection by the OWNER.
6. Upon completion of the utility work included in the contract and upon certification by the DEPARTMENT'S Engineer that the work has been completed in accordance with the plans and specifications, the OWNER will accept the adjusted, relocated, and additional facilities and will thereafter operate and maintain said facilities located within public right of way subject to the DEPARTMENT'S "Utility Accommodation Policy and Standards, 1988 edition" and any agreements in effect without further cost to the DEPARTMENT or it's CONTRACTOR.
7. For the purpose of utility coordination, relocation and reimbursement matters, the OWNER shall cooperate with the CONTRACTOR in the same manner as if directly with the DEPARTMENT in accordance with the laws of Georgia, the DEPARTMENT'S "Utility Accommodation Policy and Standards, 1988 edition" and any agreements in effect between the DEPARTMENT and OWNER. The OWNER agrees to cooperate in good faith with the CONTRACTOR and to respond to all requests for information or meetings required to reach a resolution of any disputed items.
8. The DEPARTMENT will provide its plans for the project as soon as available to allow the OWNER sufficient time to relocate the OWNERS water mains.

The Memorandum of Understanding will be incorporated into the project contract by reference or Exhibit.

APPROVED FOR THE OWNER BY:

George D. Barnes
(Signature)

3-18-08
(Date)

DEPUTY COMMISSIONER, DEPT. OF WATERSHED MGT., CITY OF ATLANTA
(Title)

APPROVED FOR THE DEPARTMENT BY:

[Signature]
(Signature)

3-24-2008
(Date)

STATE UTILITIES ENGINEER

Georgia DOT Project:
Project Fulton County
GDOT P.I.

P I No 0008415 - Hammond Drive Interchange Design Build
0008415

MEMORANDUM OF UNDERSTANDING

between the
Georgia Department of Transportation (hereafter the DEPARTMENT)
COMCAST (hereafter the OWNER)

Whereas the DEPARTMENT will accomplish the design-build project through a Design Consultant, Design Consultant Team and/or Contractor hereafter referred to as CONTRACTOR; and,

Whereas the OWNER has the following utility facilities which may need to be adjusted or relocated as a result of the proposed contract:

Type of facility or facilities of the OWNER:

- Domestic water mains and distribution lines and associated appurtenances.
- Sanitary Sewer facilities and/or Storm Drainage System
- Electrical Distribution (overhead and underground) wires, poles, etc.
- Electrical Transmission (overhead and underground) wires, poles, etc.
- Natural Gas Distribution Facilities (underground)
- Telecommunications facilities and equipment
- Cable TV facilities.
- Street Lighting
- Internet Data Service

Whereas the OWNER desires the following to be installed as new additional facilities during the proposed contract.

Insert detailed description of proposed new additional utility installations:

Comcast has 2 fiber cables attached to the existing Ga Power Poles along Hammond Drive crossing Ga 400. The poles were not shown on the prints in the FTP folder. If the poles are to be moved Comcast will transfer to the new Ga Power poles as soon as they are set. If the poles are to remain no Comcast relocation will be required.

Design Responsibilities for adjusted, relocated, and new additional utility facilities:

(1a) Whereas the OWNER does not have adequate staff to perform the design functions for the adjustment or relocation of its facilities and is willing to have this design work included in the contract to be let by the DEPARTMENT.

2a) Whereas the OWNER is willing to have this design work included in the contract to be let by the DEPARTMENT.

X 3a) Whereas the OWNER will perform its own relocation or adjustment design.

If method (1a) or (2a) for the adjustment, relocation or installation of new facilities is selected, all design necessary for the adjustment or relocation of the described utilities in accordance with the plans when approved shall be included in the project contract and accomplished by the CONTRACTOR except as follows (check none or list any work items to be performed by the OWNER):

None.

Excluded

Items: _____

Construction Responsibilities for adjusted, relocated, and new additional utility facilities:

(1b) Whereas the OWNER does not have adequate equipment and staff to adjust its facilities and is willing to have this work included in the contract to be let by the DEPARTMENT.

(2b) Whereas the OWNER is willing to have this work included in the contract to be let by the DEPARTMENT.

(3b) Whereas the OWNER will perform its own relocations or adjustments.

If method (1b) or (2b) for the adjustment, relocation or installation of new facilities is selected, all work necessary for the adjustment or relocation of the described utilities in accordance with the plans when approved shall be included in the project contract and accomplished by the CONTRACTOR except as follows (check none or list any work items to be performed by the OWNER):

None.

Excluded

Items: _____

The following is hereby mutually agreed to and understood by both parties:

1. The identification of existing facilities including preparation of base maps plans will be accomplished by the DEPARTMENT prior to award of the project contract and thereafter supplemented by the CONTRACTOR.
2. The CONTRACTOR shall coordinate reviews of the information and obtain acceptance from the OWNER and DEPARTMENT when required. However; the OWNER shall apply for and obtain any required permits from the DEPARTMENT and perform any final design or proprietary design needed to administer its own relocation work if the work will not be included in the project contract (list any work not included in the project in space provided above). If the preliminary plans indicate that no conflict exists, and the OWNER accepts this information, the OWNER shall provide a letter of "no conflict" to the CONTRACTOR.
3. The CONTRACTOR will research the property interest of each OWNER and present the findings to the DEPARTMENT and OWNER for approval. The CONTRACTOR will coordinate resolution of any disputed items. The plans and estimate for the utility work shall be subject to approval of both the DEPARTMENT and the OWNER prior to construction. If the OWNER chooses to include the subject utility work in the project construction and the research indicates that no property interest exists, and the OWNER cannot refute this finding with evidence that would substantiate the property interest in legal proceedings, the OWNER shall provide confirmation in writing that OWNER will reimburse the DEPARTMENT for any adjustment or relocations necessary; and an agreement will be prepared and executed in accordance with the DEPARTMENT'S "Utility Accommodation Policy and Standards Manual". If the OWNER chooses to perform it own relocations and the OWNER holds no property interest as stated above; the OWNER shall confirm in writing that the OWNER will relocate its own facilities at no cost to the DEPARTMENT and the CONTRACTOR.
4. All construction engineering and contract supervision shall be the responsibility of the DEPARTMENT and the CONTRACTOR to assure that all utility work included in the project contract is accomplished in accordance with plans and specifications and to consult with the OWNER before authorizing any changes or deviations which affect the OWNER's facility.
5. For Utility work included in the contract, the OWNER or the OWNER's Consultant shall have the right to visit and inspect the work at any time and advise the CONTRACTOR and the DEPARTMENT'S Engineer of any observed discrepancies or potential problems. The DEPARTMENT agrees to notify the OWNER when all utility work is completed and ready for final inspection by the OWNER.
6. Upon completion of the utility work included in the contract and upon certification by the DEPARTMENT'S Engineer that the work has been completed in accordance with the plans and specifications, the OWNER will accept the adjusted, relocated, and additional facilities and will thereafter operate and maintain said facilities located within public right of way subject to the DEPARTMENT'S "Utility Accommodation Policy and Standards, 1988 edition" and any agreements in effect without further cost to the DEPARTMENT or it's CONTRACTOR.

7. For the purpose of utility coordination, relocation and reimbursement matters, the OWNER shall cooperate with the CONTRACTOR in the same manner as if directly with the DEPARTMENT in accordance with the laws of Georgia, the DEPARTMENT'S "Utility Accommodation Policy and Standards, 1988 edition" and any agreements in effect between the DEPARTMENT and OWNER. The OWNER agrees to cooperate in good faith with the CONTRACTOR and to respond to all requests for information or meetings required to reach a resolution of any disputed items.

The Memorandum of Understanding will be incorporated into the project contract by reference or Exhibit.

APPROVED FOR THE OWNER BY:

SONNY MARTINEZ

1-25-2008

(Signature)
ENGINEER

(Date)

(Title)

APPROVED FOR THE DEPARTMENT BY:

(Signature)

3-6-2008
(Date)

STATE UTILITIES ENGINEER

Georgia DOT Project: CSNHS-0008-00(415) Fulton County
GDOT P.I. 0008415

MEMORANDUM OF UNDERSTANDING

between the
Georgia Department of Transportation (hereafter the DEPARTMENT)
and
Fulton County (hereafter the OWNER)

Whereas the DEPARTMENT proposes to undertake a design-build project to reconstruct a new bridge at Hammond Drive over Georgia 400 in Fulton County, Georgia by contract through competitive bidding procedures; and,

Whereas the DEPARTMENT will accomplish the design-build project through a Design Consultant, Design Consultant Team and/or Contractor hereafter referred to as CONTRACTOR; and,

Whereas the OWNER has the following utility facilities which may need to be adjusted or relocated as a result of the proposed contract:

Type of facility or facilities of the OWNER:

- Domestic water mains and distribution lines and associated appurtenances.
- Sanitary Sewer facilities and/or Storm Drainage System
- Electrical Distribution (overhead and underground) wires, poles, etc.
- Electrical Transmission (overhead and underground) wires, poles, etc.
- Natural Gas Distribution Facilities (underground)
- Telecommunications facilities and equipment
- Cable TV facilities.
- Street Lighting
- Internet Data Service

Whereas the OWNER desires the following to be installed as new additional facilities during the proposed contract.

Insert detailed description of proposed new additional utility installations:

Adjustment 10- Sanitary Sewer Manholes to proposed grade.

Design Responsibilities for adjusted, relocated, and new additional utility facilities:

(1a) Whereas the OWNER does not have adequate staff to perform the design functions for the adjustment or relocation of its facilities and is willing to have this design work included in the contract to be let by the DEPARTMENT.

(2a) Whereas the OWNER is willing to have this design work included in the contract to be let by the DEPARTMENT.

(3a) Whereas the OWNER will perform its own relocation or adjustment design.

If method (1a) or (2a) for the adjustment, relocation or installation of new facilities is selected, all design necessary for the adjustment or relocation of the described utilities in accordance with the plans when approved shall be included in the project contract and accomplished by the CONTRACTOR except as follows (check none or list any work items to be performed by the OWNER):

None.

Excluded Items: _____.

Construction Responsibilities for adjusted, relocated, and new additional utility facilities:

(1b) Whereas the OWNER does not have adequate equipment and staff to adjust its facilities and is willing to have this work included in the contract to be let by the DEPARTMENT.

(2b) Whereas the OWNER is willing to have this work included in the contract to be let by the DEPARTMENT.

(3b) Whereas the OWNER will perform its own relocations or adjustments.

If method (1b) or (2b) for the adjustment, relocation or installation of new facilities is selected, all work necessary for the adjustment or relocation of the described utilities in accordance with the plans when approved shall be included in the project contract and accomplished by the CONTRACTOR except as follows (check none or list any work items to be performed by the OWNER):

None.

Excluded Items: _____.

The following is hereby mutually agreed to and understood by both parties:

1. The identification of existing facilities including preparation of base maps plans will be accomplished by the DEPARTMENT prior to award of the project contract and thereafter supplemented by the CONTRACTOR.
2. The CONTRACTOR shall coordinate reviews of the information and obtain acceptance from the OWNER and DEPARTMENT when required. However; the OWNER shall apply for and obtain any required permits from the DEPARTMENT and perform any final design or proprietary design needed to administer its own relocation work if the work will not be included in the project contract (list any work not included in the project in space provided above). If the preliminary plans indicate that no conflict exists, and the OWNER accepts this information, the OWNER shall provide a letter of "no conflict" to the CONTRACTOR.
3. The CONTRACTOR will research the property interest of each OWNER and present the findings to the DEPARTMENT and OWNER for approval. The CONTRACTOR will coordinate resolution of any disputed items. The plans and estimate for the utility work shall be subject to approval of both the DEPARTMENT and the OWNER prior to construction. If the OWNER chooses to include the subject utility work in the project construction and the research indicates that no property interest exists, and the OWNER cannot refute this finding with evidence that would substantiate the property interest in legal proceedings, the OWNER shall provide confirmation in writing that OWNER will reimburse the DEPARTMENT for any adjustment or relocations necessary; and an agreement will be prepared and executed in accordance with the DEPARTMENT'S "Utility Accommodation Policy and Standards Manual". If the OWNER chooses to perform it own relocations and the OWNER holds no property interest as stated above; the OWNER shall confirm in writing that the OWNER will relocate its own facilities at no cost to the DEPARTMENT and the CONTRACTOR.
4. All construction engineering and contract supervision shall be the responsibility of the DEPARTMENT and the CONTRACTOR to assure that all utility work included in the project contract is accomplished in accordance with plans and specifications and to consult with the OWNER before authorizing any changes or deviations which affect the OWNER's facility.
5. For Utility work included in the contract, the OWNER or the OWNER's Consultant shall have the right to visit and inspect the work at any time and advise the CONTRACTOR and the DEPARTMENT'S Engineer of any observed discrepancies or potential problems. The DEPARTMENT agrees to notify the OWNER when all utility work is completed and ready for final inspection by the OWNER.
6. Upon completion of the utility work included in the contract and upon certification by the DEPARTMENT'S Engineer that the work has been completed in accordance with the plans and specifications, the OWNER will accept the adjusted, relocated, and additional facilities and will thereafter operate and maintain said facilities located within public right of way subject to the DEPARTMENT'S "Utility Accommodation Policy and Standards, 1988 edition" and any agreements in effect without further cost to the DEPARTMENT or it's CONTRACTOR.
7. For the purpose of utility coordination, relocation and reimbursement matters, the OWNER shall cooperate with the CONTRACTOR in the same manner as if directly with the DEPARTMENT in accordance with the laws of Georgia, the DEPARTMENT'S "Utility Accommodation Policy and Standards, 1988 edition" and any agreements in effect between the DEPARTMENT and OWNER. The OWNER agrees to cooperate in good faith with the CONTRACTOR and to respond to all requests for information or meetings required to reach a resolution of any disputed items.

The Memorandum of Understanding will be incorporated into the project contract by reference or Exhibit.

ITEM # 08-0315 RM 4 / 2 / 08
REGULAR MEETING

APPROVED BY THE OWNER BY:

Attest:

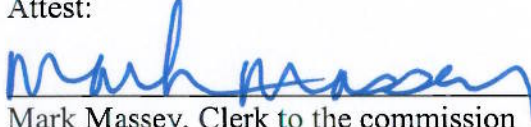
Mark Massey, Clerk to the commission

FULTON COUNTY, GEORGIA

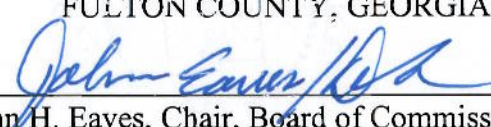
By: 
John H. Eaves, Chair, Board of Commissioners

Approved As to Form:

By: 
Office of the County Attorney

Approved As To Content:

Director of Public Works.

APPROVED FOR THE DEPARTMENT BY:

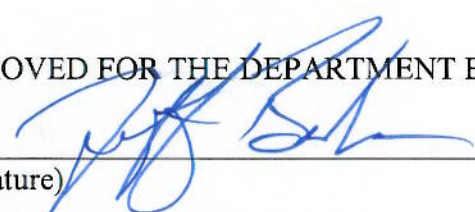
(Signature)

5-13-2008
(Date)

STATE UTILITIES ENGINEER

MEMORANDUM OF UNDERSTANDING

between the
Georgia Department of Transportation (hereafter the DEPARTMENT)
and
Georgia Power Co. (hereafter the OWNER)

Whereas the DEPARTMENT proposes to undertake a design-build project to reconstruct a new bridge at Hammond Drive over Georgia 400 in Fulton County, Georgia by contract through competitive bidding procedures; and,

Whereas the DEPARTMENT will accomplish the design-build project through a Design Consultant, Design Consultant Team and/or Contractor hereafter referred to as CONTRACTOR; and,

Whereas the OWNER has the following utility facilities which may need to be adjusted or relocated as a result of the proposed contract:

Type of facility or facilities of the OWNER:

- Domestic water mains and distribution lines and associated appurtenances.
- Sanitary Sewer facilities and/or Storm Drainage System
- Electrical Distribution (overhead and underground) wires, poles, etc.
- Electrical Transmission (overhead and underground) wires, poles, etc.
- Natural Gas Distribution Facilities (underground)
- Telecommunications facilities and equipment
- Cable TV facilities.
- Street Lighting
- Internet Data Service

Whereas the OWNER desires the following to be installed as new additional facilities during the proposed contract.

Insert detailed description of proposed new additional utility installations:

None

Design Responsibilities for adjusted, relocated, and new additional utility facilities:

____(1a) Whereas the OWNER does not have adequate staff to perform the design functions for the adjustment or relocation of its facilities and is willing to have this design work included in the contract to be let by the DEPARTMENT.

____(2a) Whereas the OWNER is willing to have this design work included in the contract to be let by the DEPARTMENT.

X(3a) Whereas the OWNER will perform its own relocation or adjustment design.

If method (1a) or (2a) for the adjustment, relocation or installation of new facilities is selected, all design necessary for the adjustment or relocation of the described utilities in accordance with the plans when approved shall be included in the project contract and accomplished by the CONTRACTOR except as follows (check none or list any work items to be performed by the OWNER):

____None.

Excluded Items: All GPC distribution facilities.

Construction Responsibilities for adjusted, relocated, and new additional utility facilities:

____(1b) Whereas the OWNER does not have adequate equipment and staff to adjust its facilities and is willing to have this work included in the contract to be let by the DEPARTMENT.

____(2b) Whereas the OWNER is willing to have this work included in the contract to be let by the DEPARTMENT.

X(3b) Whereas the OWNER will perform its own relocations or adjustments.

If method (1b) or (2b) for the adjustment, relocation or installation of new facilities is selected, all work necessary for the adjustment or relocation of the described utilities in accordance with the plans when approved shall be included in the project contract and accomplished by the CONTRACTOR except as follows (check none or list any work items to be performed by the OWNER):

____None.

Excluded Items: All GPC distribution facilities.

The following is hereby mutually agreed to and understood by both parties:

1. The identification of existing facilities including preparation of base maps plans will be accomplished by the DEPARTMENT prior to award of the project contract and thereafter supplemented by the CONTRACTOR.
2. The CONTRACTOR shall coordinate reviews of the information and obtain acceptance from the OWNER and DEPARTMENT when required. However; the OWNER shall apply for and obtain any required permits from the DEPARTMENT and perform any final design or proprietary design needed to administer its own relocation work if the work will not be included in the project contract (list any work not included in the project in space provided above). If the preliminary plans indicate that no conflict exists, and the OWNER accepts this information, the OWNER shall provide a letter of “no conflict” to the Department.
3. The CONTRACTOR will research the property interest of each OWNER and present the findings to the DEPARTMENT and OWNER for approval. The CONTRACTOR will coordinate resolution of any disputed items. The plans and estimate for the utility work shall be subject to approval of both the DEPARTMENT and the OWNER prior to construction. If the OWNER chooses to include the subject utility work in the project construction and the research indicates that no property interest exists, and the OWNER cannot refute this finding with evidence that would substantiate the property interest in legal proceedings, the OWNER shall provide confirmation in writing that OWNER will reimburse the DEPARTMENT for any adjustment or relocations necessary; and an agreement will be prepared and executed in accordance with the DEPARTMENT’S “Utility Accommodation Policy and Standards Manual”. If the OWNER chooses to perform it own relocations and the OWNER holds no property interest as stated above; the OWNER shall confirm in writing that the OWNER will relocate its own facilities at no cost to the DEPARTMENT and the CONTRACTOR.
4. All construction engineering and contract supervision shall be the responsibility of the DEPARTMENT and the CONTRACTOR to assure that all utility work included in the project contract is accomplished in accordance with plans and specifications and to consult with the OWNER before authorizing any changes or deviations which affect the OWNER’s facility.
5. For Utility work included in the contract, the OWNER or the OWNER’s Consultant shall have the right to visit and inspect the work at any time and advise the CONTRACTOR and the DEPARTMENT’S Engineer of any observed discrepancies or potential problems. The DEPARTMENT agrees to notify the OWNER when all utility work is completed and ready for final inspection by the OWNER.
6. Upon completion of the utility work included in the contract and upon certification by the DEPARTMENT’S Engineer that the work has been completed in accordance with the plans and specifications, the OWNER will accept the adjusted, relocated, and additional facilities and will thereafter operate and maintain said facilities located within public right of way subject to the DEPARTMENT’S “Utility Accommodation Policy and Standards, 1988 edition” and any agreements in effect without further cost to the DEPARTMENT or it’s CONTRACTOR.
7. For the purpose of utility coordination, relocation and reimbursement matters, the OWNER shall cooperate with the CONTRACTOR in the same manner as if directly with the DEPARTMENT in accordance with the

laws of Georgia, the DEPARTMENT'S "Utility Accommodation Policy and Standards, 1988 edition" and any agreements in effect between the DEPARTMENT and OWNER. The OWNER agrees to cooperate in good faith with the CONTRACTOR and to respond to all requests for information or meetings required to reach a resolution of any disputed items.

The Memorandum of Understanding will be incorporated into the project contract by reference or Exhibit.

APPROVED FOR THE OWNER BY:

Mark Tilden
(Signature)

February 28, 2008
(Date)

Project Manager - DOT / Joint Use

(Title)

APPROVED FOR THE DEPARTMENT BY:

Jeff Burk
(Signature)

3-6-2008
(Date)

STATE UTILITIES ENGINEER

First Use Date: November 1, 2002
Revised February 5, 2008

**DEPARTMENT OF TRANSPORTATION
STATE OF GEORGIA**

SPECIAL PROVISION

Project Number: CSNHS-0008-00(415)

P.I. Number: 0008415

Fulton County

SECTION 103- Award and Execution of Contract

Delete paragraph one of Subsection 103.02 and substitute the following:

If a Contract is Awarded, it will be Awarded to the lowest reliable bidder whose Proposal shall have met all the prescribed requirements. The Contract will be Awarded, if at all, within 50 calendar days after the opening of the Proposals, unless a longer period is specified in the Proposal or the successful Bidder agrees in writing a longer period for the Award.

**DEPARTMENT OF TRANSPORTATION
STATE OF GEORGIA
SPECIAL PROVISION**

**June 2, 2008
July 10, 2008
Updated: September 5, 2008**

**SECTION 107 – LEGAL REGULATIONS
AND RESPONSIBILITIES TO THE PUBLIC**

**CSNHS-0008-00 (415) Fulton County
P.I. No. 0008415
SR 400 from @ Hammond Drive**

Subsection 107.18, "Acquisition of Right-of-Way" is modified by the addition of the following:

The following project NH000-0056-01 (052), PI No. 721850 is a companion to the above project.

<u>Parcel No.</u>	<u>Title/Date</u>	<u>Possession</u>	<u>Remarks</u>
5	Deed/5/30/2008	Oct. 31, 2008*	To be removed by property management on/or before 2-1-09*
9	Deed/5/30/2008	Oct. 31, 2008*	To be removed by property management on/or before 2-1-09*
*7	Title and possession expected on February 1, 2009		
*8	Title and possession expected on February 1, 2009		

* These are anticipated dates. The Contractor is to verify possession through the Department before entering upon this property for any reason.

Physical construction may proceed when authorization is granted, but the contractor will take no action that will result in unnecessary inconvenience, disproportionate injury or any action coercive in nature to occupants of residences, businesses, farms, or nonprofit organizations which have not been moved from the right of way.

Page 2
CSNHS-0008-00(415) Fulton County
Section 107 – Legal Regulations
June 2, 2008
July 10, 2008
Updated: September 5, 2008

Depending on construction sequencing, the lack of possession and use of the above referenced parcels could interfere with construction operations and the contractor's ability to perform as specified.

The Contractor shall not commence work on any occupied parcel until the Department has title and possession of parcels.

DEPARTMENT OF TRANSPORTATION
STATE OF GEORGIA
SPECIAL PROVISION

PROJECT: CSNHS-0008-00(415), FULTON COUNTY,
PI # 0008415

Section 107 – Legal Regulations and Responsibility to the Public

Add the following to Subsection 107.23:

G. Protection of Federally Protected Environmentally Sensitive Species

The following conditions are intended as a minimum to protect these species and their habitat during any activities that are in close proximity to the known location(s) of this species. The specific activity that these conditions apply to is the replacement of the existing Hammond Drive bridge over SR 400 in Fulton County.

1. The Contractor shall advise all project personnel employed to work on this project about the potential presence and appearance of federally protected Eastern phoebes (*Sayornis phoebe*), cliff swallows (*Petrochelidon pyrrhonota*) or barn swallows (*Hirundo rustica*) and that there are civil and criminal penalties for harming, harassing, or killing these species, which are protected under the Migratory Bird Treaty Act of 1918. Pictures and habitat information will be provided to the Contractor at the preconstruction conference.
2. The above referenced activities shall take place outside of the breeding and nesting season of Eastern phoebes and swallows, which typically begins April 1st and extends through August 31st, unless exclusionary barriers are installed as described below and successfully prevent the nesting of these migratory bird species on the bridge(s). Exclusionary devices in the form of netting made of plastic, canvas or other materials that are proposed by the contractor may be installed on the bridge(s) prior to February 1st, but after August 31st. The following requirements must be met in order for exclusionary netting to be considered appropriate:
 - a. Prior to the installation of any exclusionary devices, the project ecologist must be notified by phone at (404) 699-4301 or (404) 699-4400, or by email at jcollazo@dot.ga.gov of the decision to install exclusionary devices under the existing bridge and the date of installation.
 - b. Project personnel shall be alert to the possibility of migratory bird nesting activity taking place earlier than is typically known to occur, or previously unnoticed nesting migratory birds that have become trapped under the bridge(s) subsequent to exclusionary device installation. If, at any time immediately prior to, during or after exclusionary device installation, such occurrences are observed, all construction/demolition activity on the bridge(s) must immediately cease and be postponed until after August 31st, the exclusionary devices shall be immediately removed, and the project ecologist shall be immediately notified as described above. Only if nests are not found or existing nests are unoccupied, is the installation of exclusionary devices is permissible.
 - c. On bridges that are to be jacked, painted or demolished, exclusionary netting should be placed along the full length of the bridge to prevent the birds from accessing any existing nesting habitat. The exclusionary netting shall be installed prior to February 1st and, unless it fails to prevent the nesting of migratory birds, shall remain in place until August 31st or until the bridgework is complete, whichever occurs first.
 - d. The exclusionary netting must prevent birds from accessing nesting habitat along the full length of the bridge until the commencement of jacking/painting/demolition work (i.e., sawing or removal of bridge items for operational access). If the exclusionary netting fails to prevent nesting (i.e., birds are able to bypass barriers and build nests within the exclusionary netting), the netting shall be immediately removed and all construction activities associated with the bridge must be postponed until after August 31st when the breeding season is complete.
3. During construction activities, exclusionary netting shall be inspected for holes or other defects that impair the netting's ability to exclude phoebes or swallows from inhabiting the bridge. In the event any incident occurs that causes harm to Eastern phoebes, cliff swallows or barn swallows, or that could be detrimental to the continued existence of Eastern

Section 107 – Legal Regulations and Responsibility to the Public

phoebes, cliff swallows or barn swallows along the project corridor, the Contractor shall report the incident immediately to the Project Engineer who in turn will notify:

- a. U.S. Fish and Wildlife Service, Athens Field Office at (706) 613-9493;
- b. Federal Highway Administration (FHWA), Georgia Division at (404) 562-3630; and
- c. Glenn Bowman, GA Dept. of Transportation, Office of Environment/Location at (404) 699-4401 or (404) 326-5871.

In the event of possible harm to Eastern phoebes, cliff swallows or barn swallows, the above agencies and the Project Engineer shall be notified immediately and all activity shall cease pending consultation by the Department with the U. S. Fish and Wildlife Service and the lead Federal Agency.

4. Following project completion, a report summarizing any incidents with Eastern phoebes, cliff swallows or barn swallows shall be submitted by the Contractor to the:
 - a. the Project Engineer;
 - b. U.S. Fish and Wildlife Service, 105 West Park Drive, Suite D, Athens, GA 30606;
 - c. Federal Highway Administration, 61 Forsyth Street, S.W., Suite 17T100, Atlanta, GA 30303;
 - d. Nongame/Endangered Wildlife Program, Georgia Department of Natural Resources, 115 Rum Creek Dr, Forsyth, GA 31029 and;
 - e. Georgia Department of Transportation, Office of Environment/Location, 3993 Aviation Circle, Atlanta, GA 30336.
5. All costs pertaining to any requirement contained herein shall be included in the overall bid submitted unless such requirement is designated as a separate Pay Item in the Proposal.

Protected species on the Project

Eastern phoebe *Sayornis phoebe*

Description

- Approximately 6-7 inches in length
- Dark head with grayish-olive upperparts
- Frequently wags tail
- Often builds nest under bridges, in large culverts, or around buildings near water
- Nest is mud and grass lined with moss and hair; contains up to 5 white eggs
- Song is a clear “fee-bee” or “fee-bit-it” often repeated



Adult Eastern phoebe



Eastern phoebe nest under a bridge

**There are civil and criminal penalties for harming or killing this animal
and its nest or eggs. See Special Provisions 107.23G**

PROTECTED SPECIES ON THE PROJECT



Cliff Swallow in flight.



Cliff Swallows at nests.

Cliff Swallow

Description

- Body length is 5.5 inches; wingspan is 12 inches
- Pale orange rump and forehead; square tail tip
- Dark blue cap and upperparts; dark brown throat
- Often nest under bridges; distinctively shaped mud nests



Cliff Swallows at nests.



Cliff Swallows drinking from a puddle.

There are civil and criminal penalties for harming or killing this animal and its nest or eggs.

See Special Provision 107.23 G.

PROTECTED SPECIES ON THE PROJECT



Adult Barn Swallow



Barn Swallow nest under a bridge.

Barn Swallow

Description

- 6 $\frac{3}{4}$ inches in length
- Long, deeply forked tail
- Upperside iridescent blue, underparts either cinnamon or white, throat reddish-brown
- Nests in pairs or small colonies



Barn Swallow nest under a bridge.



Immature Barn Swallows in nest.

There are civil and criminal penalties for harming or killing this animal and its nest or eggs.

See Special Provision 107.23 G.

**DEPARTMENT OF TRANSPORTATION
STATE OF GEORGIA**

SPECIAL PROVISION

**Section 108—Prosecution and Progress
(Federal Aid Projects)**

Delete Subsection 108.06 and substitute the following:

The Engineer has the authority to suspend the Work wholly or in part, for as long as he may deem necessary, because of unsuitable weather, or other conditions considered unfavorable for continuing the Work, or for as long as he may deem necessary by reason of failure of the Contractor to carry out orders given, or to comply with any provisions of the Contract. If the performance of all or any portion of the Work is suspended or delayed by the Engineer, in writing, for an unreasonable period of time (not originally anticipated, customary, or inherent to the construction industry) and the Contractor believes that additional compensation and/or contract time is due as a result of such suspension or delay, the Contractor shall submit to the Engineer, in writing, a request for adjustment within 7 calendar days of receipt of the notice to resume work. The request shall set forth the reasons and support for such adjustment.

Upon receipt, the Engineer will evaluate the Contractor's request. If the Engineer agrees that the cost and/or time required for the performance of the Contract has increased as a result of such suspension and the suspension was caused by conditions beyond the control of, and not the fault of, the Contractor, its suppliers, or subcontractors at any approved tier, and not caused by weather, the Engineer will make an adjustment (excluding profit) and modify the Contract in writing accordingly. The Engineer will notify the Contractor of his/her determination whether or not an adjustment of the Contract is warranted.

No contract adjustment will be allowed unless the Contractor has submitted the request for adjustment within the time prescribed.

No contract adjustment will be allowed under this clause to the extent that performance would have been suspended or delayed by any other cause, or for which an adjustment is provided for or excluded under any other term or condition of this Contract.

February 4, 2008

DEPARTMENT OF TRANSPORTATION

STATE OF GEORGIA

SPECIAL PROVISION

SECTION 108—PROSECUTION AND PROGRESS

PROJECT No: CSNHS-0008-00(415)

PI 0008415

Add the following to Subsection 108.08:

For this project, an overall completion date has been established.

In order to minimize the disruption of normal traffic flow, separate completion times are specified for those portions of the work that require closing of lanes or detours as specified in Subsection 150.11.

1. Failure to open those roadways as detailed in Special Provision 150.11 A, B and C will result in the assessment of liquidated damages in the amount of \$1,000.00 per hour or portion thereof until the road is open to traffic.
2. The GDOT ITS System shall not be taken out of service for more than 72 hours during construction. Failure to have the ITS system operational 72 hours after shut down shall result in assessment of liquidated damages at a rate of \$1,000.00 per hour or portion thereof until the system is operational.
3. Failure to submit to the Department a Utility Conflict Matrix in the Department's prescribed format within 180 days of Notice to Proceed shall result in assessment of liquidated damages in rate of \$1,000.00 per calendar day until the matrix has been received.
4. Failure to submit to the Department a Preliminary Utility Status Report within 120 days after the Notice to Proceed has been given for the contract shall result in assessment of liquidated damages in rate of \$1,000.00 per calendar day until the report has been received.

These rates are cumulative and in addition to the Liquidated Damages which may be assessed in accordance with Subsection 108.08 for failure to complete the overall project on time.

**DEPARTMENT OF TRANSPORTATION
STATE OF GEORGIA**

**Project Number: CSNHS-0008-00(415)
P.I. Number: 0008415
Fulton County**

SPECIAL PROVISION

Section 150—Traffic Control

Add the following to Section 150

150.11 SPECIAL CONDITIONS

- A. For SR 400, Hammond Drive, and West Concourse Parkway, the Contractor shall not install lane closures, perform flagging, or move equipment on the travel way between the hours of 5:00 a.m. to 9:00 p.m. Monday thru Friday and between the hours of 10:00 a.m. to 9:00 p.m. Saturday and Sunday. Failure to adhere to these restrictions will result in liquidated damages as Specified in Sub section 108.08.
- B. For all other side streets except as those mentioned above, the Contractor shall not install lane closures, perform flagging, or move equipment on the travel way that interferes with traffic flow between the hours of 5:00 a.m. to 9:00 a.m. and 3:00 p.m. to 9:00 p.m. Monday thru Friday. Failure to adhere to these restrictions will result in liquidated damages as Specified in Sub section 108.08.
- C. The Contractor shall not install lane closures, perform flagging, or move equipment on the travel way from the Wednesday before Thanksgiving Day to the first Business day after New Year's Eve yearly between the hours of 5:00 a.m. to 10:00 p.m. Monday thru Friday and between the hours of 8:00 a.m. to 10:00 p.m. Saturday and Sunday. Failure to adhere to these restrictions will result in liquidated damages as Specified in Sub section 108.08.
- D. **WORKZONE LAW ENFORCEMENT:** WorkZone Law Enforcement consists of utilizing a uniformed police officer equipped with patrol vehicle and blue flashing lights to enforce traffic laws in construction workZones and the administration of this service. Payment for workZone law enforcement will be made only for the utilization in WorkZones during lane closures, traffic pacing, or other activities that occur within travel lanes. The Contractor will be responsible for negotiating a rate of reimbursement and making reimbursement to that law enforcement agency.

The Contractor will be responsible for coordinating and scheduling the utilization of the Work Zone Law Enforcement. The Engineer may require the use of Work Zone Law Enforcement at specific times and locations during interstate closures.

WorkZone Law Enforcement will be measured for payment by the hour. The Contractor shall provide a daily work record containing the actual number of hours charged by the police officer. The daily work record shall be compiled on a form provided by the Department, signed by the police officer, signed by the Contractor's Worksite Traffic Control Supervisor attesting that the police was utilized during the time recorded, and then submitted to the Engineer.

Payment shall be full compensation for reimbursing the law enforcement agency, and for all cost incurred by the Contractor in coordinating, scheduling, and administering the item Work Zone Law Enforcement.

Work Zone Law Enforcement will be measured for payment by the hour up to the maximum number of hours included in the contract. The Department will not pay for any Work Zone Law Enforcement beyond the number of hours set up in the Contract. The cost of utilization above the number of hours set up in the contract shall be included in the Lump Sum price bid for Construction Complete.

Payment will be made under:

ITEM NO. 150-9011 Traffic Control WorkZone Law Enforcement.

**Department of Transportation
State of Georgia
Special Provision**

Project Number: CSNHS-0008-00(415)

P.I. Number: 0008415

Fulton County

Section–500 Concrete Structures

Delete Subsection 500.3.05.T.9.c and substitute the following:

- c. After belting, dragging, or brooming and when shown on the Plans, groove the bridge deck and approach slabs perpendicular to the center line as follows:
- 1) Do not begin grooving until the bridge deck is cured according to Subsection 500.3.05.Z, “Cure Concrete”.
 - 2) If necessary, groove in conjunction with planing required to make the surface corrections specified in Subsection 500.3.06.D, “Bridge Deck Surface Check”. Wait until the concrete is hard enough to support the equipment without distorting.
 - 3) Cut Grooves into the hardened concrete using a mechanical saw device capable of producing grooves 0.125 in (3 mm) wide, 0.125 in (3 mm) deep, and 0.5 in (13 mm) apart, center-to-center.
 - 4) Extend the grooves across the slab to within 1 ft (300 mm) of the gutter lines.

Office of Materials and Research

**DEPARTMENT OF TRANSPORTATION
STATE OF GEORGIA**

SPECIAL PROVISION

**Project Number: CSNHS-0008-00(415)
P.I. Number: 0008415
Fulton County**

Section 713—Organic and Synthetic Material Fiber Blanket

Delete Section 713 and add the following:

713.1 General Description

This work includes furnishing and placing straw, excelsior, coconut fiber, wood fiber, or synthetic blankets over previously prepared and grassed (temporary or permanent) areas as shown on the Plans or as directed by the Engineer.

713.1.01 Definitions

- Straw Blanket: A machine-produced blanket of clean, weed-free, consistently thick straw from agricultural crops. The straw is evenly distributed over the entire area of the blanket.
- Excelsior Blanket: A machine-produced mat of curled wood excelsior. Eighty percent consists of 6 in (150 mm) or longer fiber evenly distributed over the entire blanket.
- Coconut Fiber Blanket: A machine-produced blanket of 100 percent coconut fiber evenly distributed over the entire blanket.
- Wood Fiber Blanket:
 - Type I—A machine-produced blanket manufactured with reprocessed wood fibers to a consistent thickness.
 - Type II—A hydraulically applied bonded fiber matrix which upon drying, adheres to the soil in the form of a continuous 100 percent coverage, biodegradable erosion control blanket
- Synthetic Fiber Blanket—A machine produced uniform blanket of ultraviolet degradable polypropylene staple fibers reinforced with ultraviolet degradable polypropylene netting.

713.1.02 Related References

A. Standard Specifications

General Provisions 101 through 150.

B. Referenced Documents

General Provisions 101 through 150.

713.1.03 Submittals

Use approved materials from [OPL 62](#) without further testing. Otherwise, submit materials for testing before use.

713.2 Materials

Use blankets that meet the following requirements for placement on slopes and waterways. For a list of organic material fiber blankets, see [QPL 62](#).

A. Straw Blanket

Use blankets at least 48 in (1.2 m) wide and at least 3/8 in (9 mm) thick with a minimum dry weight of 0.5 lb/yd² (270 g/m²) and a stitch pattern and row spacing of no more than 2 in (50 mm).

Have the top side covered with a photo-degradable plastic mesh having a maximum mesh size of 1/2 in by 1/2 in (13 mm by 13 mm). Sew the mesh to the straw with biodegradable thread.

Use this blanket on slopes only.

B. Excelsior Blanket

Use a smolder-resistant blanket with the top side clearly marked. Use a blanket at least 48 in (1.2 m) wide and 1/4 in (6 mm) thick with a minimum dry weight of 0.8 lb/yd² (430 g/m²) and a stitch pattern and row spacing of no more than 2 in (50 mm).

- Slopes: Have the top side covered with a photo-degradable plastic mesh having a maximum mesh size of 1-1/2 by 3 in (38 by 75 mm).
- Waterways: Have the top and bottom sides of the blanket covered with a photodegradable plastic mesh having a maximum mesh size of 1 1/2 x 3 in (38 x 75 mm), sewn to the fiber with biodegradable thread or otherwise bonded as approved by the Engineer.

C. Coconut Fiber Blanket

Use a blanket at least 48 in (1.2 m) wide and 1/4 in (6 mm) thick with a minimum dry weight of 0.5 lb/yd² (270 g/m²) and a stitch pattern and row spacing of no more than 2 in (50 mm). Use the blanket in waterways only.

Ensure that both sides of the blanket are covered with a photo-degradable plastic mesh with a maximum of 5/8 by 5/8 in (19 by 19 mm). Have the mesh sewn to the fiber with a breakdown-resistant synthetic yarn.

D. Wood Fiber Blanket

Type I

- Use a machine produced blanket manufactured to a consistent thickness using reprocessed wood fibers.
- Use a blanket at least 48 in (1.2 m) wide with a minimum dry weight of 0.35 lb/yd² (190 g/m²).
- Ensure that the top side of the blanket is covered with a photo-degradable plastic mesh with a maximum of 5/8 x 3/4 in (16 x 19 mm) securely bonded to the mat.
- Ensure the fibers do not contain a growth that inhibits germination.
- Use Type I blanket on shoulder construction on resurfacing projects.

Type II

For Shoulder Construction on Resurfacing Projects

- Ensure the bonded fiber matrix is composed of long strand wood fibers or cellulosic-based fibers held together by a bonding agent, which, upon drying, becomes insoluble and non-dispersable.
- Apply the matrix at the following at the rate of 3000 lbs/acre (3.4 Mg/ha) for shoulder construction on resurfacing projects.
- Do not apply the bonded matrix on saturated soils or immediately before, during or after rainfall. Allow the matrix to dry for at least 24 hours after installation. After drying period, ensure that the bonded fiber matrix does not inhibit the germination or growth of plants beneath and through the formed matrix blanket and that it does not form a water insensitive crust.
- If bonded fiber matrix is to be used, the application of straw mulch for grassing operations is not required.

E. Synthetic Fiber Blanket

Use a blanket having a minimum net size of 5/8 x 3/4 inch (16 x 19 mm). Ensure the netting is securely bonded to the blanket and that the blanket conforms to the following physical properties:

<u>PROPERTY</u>	<u>MINIMUM VALUE</u>	<u>TEST METHOD</u>
Weight	1 oz/sq. yd (34 g/m ²)	
Roll Width	48 inch (1.2 m)	
Tensile Strength Length	6 lbs./in	ASTM D 1682 [6" (150 mm) strip]

Use Synthetic fiber blanket on slopes only.

F. Net-free Excelsior Blanket

Use only on 4:1 and flatter slopes.

Use a smolder-resistant blanket at least 48 in (1.2m) wide and ¼ in (6mm) thick with a minimum dry weight of 0.73 lb/yd² (390 g/m²).

Use a blanket consisting of curled, interlocking, Aspen fibers with a cross section of 0.038±0.010 in X 0.018±0.003 in (0.97±0.25mm X 0.45±0.08mm). Ensure that a minimum of 80% of the fibers are at least 6 in (150mm) long. Ensure that the fibers are stitched with biodegradable thread in a 2 in X 4 in ±0.5 in (50mm X 100mm ±13mm) pattern.

G. Anchoring Staples

Use anchoring staples made from minimum 11-gauge wire, formed into a U shape. Ensure that the legs are at least 6 in (150 mm) long and the crown at least 1 in (25 mm) wide. Use staples rigid enough to penetrate the soil without distortion.

713.3 Construction Requirements

713.3.01 Personnel

General Provisions 101 through 150.

713.3.02 Equipment

General Provisions 101 through 150.

713.3.03 Preparation

Before placing the blanket, complete the grassing operations, smooth the area, and remove stones, lumps, roots, or other material that would prevent the blanket from laying snugly on the soil.

713.3.04 Fabrication

General Provisions 101 through 150.

713.3.05 Construction

A. Placing Blanket

Place blankets or mats vertically on slopes, beginning at the top of the slope and extending to the bottom of the slope. Horizontal installation of the blankets is not permitted.

Place the blanket within 24 hours after planting and before rain or watering. Place the blanket on slopes and waterways as follows:

1. On Slopes

Unroll the blanket with the netting on top and the fibers contacting the soil over the entire slope. When using two or more blankets to cover an area, overlay the joint 4 in (100 mm) and staple through the joint. Overlap the ends of the blanket at least 6 in (150 mm) with the upgrade section on top and staple through the overlap.

2. In Waterways

In waterways, ditches, flumes, and channels unroll the blanket with netting sewn on both sides and place in contact with the soil beginning at the downstream terminal and progressing upstream of the blanket according to the Construction Detail for Permanent Soil Reinforcing Mat.

Allow a longitudinal seam only if the blankets overlap at least 6 in (150 mm) and are securely stapled. Overlap ends of the blanket at least 6 in (150 mm) with the upgrade section on top.

Insert 12 in (300 mm) of the upslope end of the first row of blankets into a 6 in (150 mm) deep anchor slot. Staple the blanket in the slot bottom, backfill the slot, and solidly tamp.

B. Stapling

Drive staples vertically into the ground to anchor the plastic mesh. Place the staples approximately 2 yd (2 m) apart on each side of the blanket and add one row in the center alternately spaced between each side staple.

Where blankets lay side to side, place each staple so that half of the staple anchors mesh from each blanket.

At the beginning of a blanket, space staples approximately 12 in (300 mm) apart in a row.

C. Steep Slopes

The Engineer may specify additional staples or check slots in waterways where slopes are steep or large water volumes and/or velocities are anticipated.

713.3.06 Quality Acceptance

General Provisions 101 through 150.

713.3.07 Contractor Warranty and Maintenance

Maintain the blanket installation throughout the life of the Contract. If before Final Acceptance any staples become loose or lift up or if the blanket becomes loose, torn, or undermined, then fix the problem by reshaping, regrassing, refertilizing, or replacing damaged areas. Repairs are done without additional compensation.

713.4 Measurement

No measurement to be included for this item.

713.4.01 Limits

General Provisions 101 through 150.

713.5 Payment

The preliminary preparation of the areas on which the blanket is to be placed, including seeding or sodding, will be paid for under CONSTRUCTION COMPLETE.

Straw blanket excelsior blanket, coconut fiber blanket, Type I wood fiber blanket (slopes) or synthetic fiber blanket will be paid for under CONSTRUCTION COMPLETE. Wood Fiber Blanket Type I & Type II (shoulders) will be paid for under CONSTRUCTION COMPLETE. Includes construction of the Item including all laps, materials, equipment, tools, labor, incidentals, and maintenance.

**DEPARTMENT OF TRANSPORTATION
STATE OF GEORGIA**

SPECIAL PROVISION

**Project Number: CSNHS-0008-00(415)
P.I. Number: 0008415
Fulton County**

SECTION 999 – DESIGN-BUILD

999.1 DESCRIPTION

A. General

1. **Project Location:** The location of the construction work included in this Project is shown in the Costing Plans. This Project is located in Fulton County.
2. **Design-Build Concept:** The Contractor and a design consultant (or design consultant team) shall work together to design and build the Project. The design consultant shall either be acting as a subcontractor to the Contractor or as a joint-venture member with whom this agreement has been executed. In this document, the words “design consultant” or “design consultant team” shall refer to the consultant firm or consultant team acting as a subcontractor or joint-venture team member to the Contractor. The Department will have oversight responsibilities only, which include performing official reviews and granting approvals of design work.

The Contractor shall not begin any ground-breaking activities until the following have been approved by the Engineer:

- **Basis of the design**
- **NEPA document re-certification**
- **Approved Permits (including but not limited to NWP and traffic signal permits)**
- **Plans Approved for Construction by the Engineer (See also 999.4 CONSTRUCTION)**
- **Erosion Sedimentation and Pollution Control Plans approved by the Engineer along with the 14-day wait period after the NOI submission to EPD**
- **QC/QA Plan**
- **Traffic Control Plan**
- **Traffic Management Plan**
- **Utility Agreements, Utility Encroachment Permits, Utility Relocation Plans, and Contractor Certification of “No-Conflict”**

Bids on this project shall reflect designing and constructing the project as shown in the Scope (999.1.A.3) and applicable portions of the Plans Package. No exceptions shall be assumed by the Contractor. However, alternative proposals on portions of the work will be entertained once the project is awarded. The VE Specification, including procedures, in which the Contractor and Department have a share in the savings, is included in this contract. Alternative proposals shall not conflict with the overall completion date of the project or intermediate completion dates unless otherwise approved by the Department.

The Contractor shall use those entities prequalified in related disciplines (design, traffic analysis, geotechnical, etc.) as presented in the Statement of Qualifications. Revisions to the team and/or the proposed assignments reflected in the Statement of Qualifications shall be approved by the Engineer. Additional disciplines needed to meet the requirements of this special provision that were not identified in the Statement of Qualifications shall meet GDOT prequalifications as required and any applicable standards, policies or guidelines of the local agencies or utility owners.

All proposal materials shall become the property of the Department and may be used by the Department without exception. Ideas originating with qualified proposers may be used by the proposer awarded the project.

Where specifications differ with this proposal, the Special Provision 999 Design-Build shall take precedence unless otherwise revised through the amendment process. Prescriptive provisions found in the Specifications shall be followed for this project.

3. Project Scope: This Project involves the bridge replacement at Hammond Drive over SR 400 and the addition of auxiliary lanes on the northern side of Hammond Drive bridge along the northbound and southbound lanes of GA 400 in Fulton County. The project contains the following features:

- Begin Project occurs at the beginning of the taper at the I-285 Overpass over SR 400.
- End Project occurs at the beginning of the taper at Mount Vernon Highway Bridge
- Project length is approximately 0.77 miles.
- The proposed Auxiliary Lanes are to be located adjacent to the existing outside travel lanes for approximately 0.52 miles.
- Guardrail is proposed on the outside of ramps and auxiliary lanes in four locations on the project.
- Proposed pavement is to be full-depth asphalt along SR 400 Auxiliary lanes and a portion of the Hammond Drive on and off ramps using a design life of 10 years. The remaining portion of the ramps shall be constructed with full depth PCC paving using a design life of 20 years. Hammond Drive shall be constructed with full depth asphalt for widening sections using a 20-year design life. Existing pavement along Hammond Drive shall be retained, See costing plans for typical sections and locations.
- A minimum of four lanes of traffic in each direction shall be maintained along GA 400 and a minimum of two lanes of traffic in each direction shall be maintained along Hammond Drive. Temporary lane closures shall be in accordance with section 150.
- The following Design Variances have been approved: 1) Substandard median opening spacing (463', 453', 543'), and 2) Substandard limited access rights (Sta. 118+91.45 LT – 182').
- The two (2) sound barriers constructed as part of this project will be temporary, and their final location will be established as part of P.I. 721850.
- Ramp meters will not be installed on this project.
- The Contractor shall verify if step down construction was used to install the existing culverts under SR 400. If determined by the Engineer that step down construction was used then the Contractor shall reconstruct portions of the existing culverts in order to bring the existing culvert from the point of the step down in order to bring the existing culvert up to current load specifications. This only applies to those areas where the ramps are being constructed.
- The Contractor shall be responsible for developing the sanitary sewer adjustment plan, and for the construction necessary to relocate or make adjustments to the existing sanitary sewer within the limits of construction. See the executed MEMORANDUM OF UNDERSTANDING between the Department and Fulton County for this scope of work.

- A temporary chain link fence 8' in height and approximately 230' in length shall be installed within the parking lot of Parcel 5 along the frontage of Ramp SR1 and at the back of the easement. Approximate station and offsets along Ramp SR 1, as identified in the Costing Plans, are 213+45/67'RT, 215+28/66'RT, and 215+60/94'RT. The Contractor shall remove this temporary fence once construction is complete.
- A VE Study was performed for P.I. No. 721850, and was approved on May 12, 1997. All relevant recommendations pertaining to P.I. No. 0008415 have been incorporated in the plans package.
- The Contractor shall be responsible for developing and implementing A Traffic Management Plan (TMP) per Department's TOPPS Policy #5240-1. The TMP shall include Temporary Traffic Control, Transportation Operations, and Public Involvement components.

The work covered under this Specification includes the furnishing of all materials, labor, tools, equipment, and other incidental items for the designing, detailing, and construction of the Project contained in the Project Scope. The Contractor shall make all the improvements for this Project within the right of way and easement limits that are shown in the provided Costing Plans (See also 999.1.A.5 Right of Way). Advanced signing relative to proposed work, to be placed outside the limits shown on the Costing Plans, shall be included in the work and paid for under CONSTRUCTION COMPLETE.

The Contractor shall restore or replace existing facilities in kind or upgrade. Possible affected resources includes, but not limited to the following: GDOT ITS system, signing and marking, and utilities.

GDOT ITS System in Conflict with project:

- Video detection cameras
- CCTV surveillance cameras
- ITS communication fiber and conduit
- Variable Message signs
- Utilities for powering ITS System

Note: The GDOT ITS System is a vital part of traffic management in metro Atlanta and shall not be taken out of service for more than 72 hours during construction. See special provision section 108.

Information related to "existing conditions", as reflected in the plans package, is for information only. The Contractor shall be aware that existing conditions found in the plans package may have changed since the field survey work and associated design effort were completed. The plans package, along with the specifications, shall attempt to highlight areas of known changes in the existing conditions. These areas may or may not include all actual areas where existing conditions differ from those that currently exist in the field. The Contractor shall be responsible to verify all existing conditions. No claims shall be considered due to decisions/assumptions made by the Contractor based on "existing conditions" reflected in the plans package.

The contractor may propose alternative methods/solutions to this requirement once the project is awarded, but shall provide the same, or better, facilities as shown in the Plans Package and specifications and meet the following criteria:

- No additional or increased costs
- No extension in overall schedule (or specified milestones)
- No exceptions to specifications included in this contract
- Alternatives shall be approved by the Engineer

Note: Geometric design (including but not limited to horizontal and vertical alignments, radii, etc.) shall be as shown in Plans Package or may be revised as long as the design incorporates more conservative values.

4. **Utilities:** The Contractor shall have the responsibility of coordinating the project construction with all utilities that may be affected. Coordinating responsibilities shall include but not be limited to the following:
- a. The Contractor shall be responsible for the cost of utility coordination. Coordination shall include, but shall not be limited to, contacting each Utility Owner to advise of the proposed project; supplemental verification of the locations of existing utility facilities (including the employment of additional Overhead/Underground Subsurface Utility Engineering investigations (SUE) as described in section 999.3.B.1.s of this specification); and determining requirements for the relocation or adjustment of facilities.
 - b. The Department and/or the Utility Owner shall be responsible for the cost of utility relocation (this may change according to the details contained in the MOUs), where they hold a property interest, and in accordance with the Department's "Utility Accommodation Policy and Standards Manual". Details are provided in the attached Memorandum of Understanding (MOU) executed between the Department and each Utility Owner.
 - c. The Contractor shall design the project to avoid conflicts with utilities when feasible, and minimize impacts where conflicts cannot be avoided (See Section 999.3.B.1.s). The Contractor shall submit to the Department a SUE Utility Impact Analysis in the Department's prescribed format within 180 days of notice to proceed.
 - d. The Contractor shall initiate early coordination with all Utility Owners located within the project limits.
 - e. The Contractor shall coordinate and conduct a preliminary review meeting with the Utility Owners to assess and explain the impact of the project. The Department's Project Manager, District Construction Engineer (or designee), and District Utilities Engineer (or designee) shall be included in this meeting. The Contractor shall record

the minutes for this meeting and distribute to all attendees for their review and concurrence.

- f. The Contractor shall research the property interests of each Utility Owner's facilities. If there is a dispute over property interests with a Utility Owner, the Contractor shall be responsible for resolving the dispute. The Contractor shall meet with the Department's District Utilities Engineer (or designee) to present the property interests information gathered. This information shall be sufficient for the District Utilities Engineer (or designee) to certify the extent of the Utility Owner's property interests. The Department shall have final approval authority as to the Contractor's determination of whether the Utility Owner has property interests.
- g. The Contractor shall prepare and submit to the Department a Preliminary Utility Status Report within 120 days after the Notice to Proceed has been given for the contract. This report shall include a listing of all Utility Owners located within the project limits and a recommendation as to the extent of each Utility Owner's property interests. This report shall include copies of easements, plans, or other supporting documentation that substantiates any property interests of the Utility Owners. The report shall also include a preliminary assessment of the impact to each Utility Owner.
- h. Depending on the provisions stipulated in the Memorandum of Understanding (MOU) between the Department and each Utility Owner the Contractor shall be responsible for one of the following Design Activities:
 - The Contractor shall provide Utility Owners with design plans and Preliminary Utility Plans as soon as the plans have reached a level of completeness adequate to allow them to fully understand the project impacts. The Utility Owner will use the Contractor's design plan for preparing Utility Relocation Plans, cost estimates, and respective Utility Adjustment Schedules (UAS). If a party other than the Utility Owner prepares Utility Relocation Plans, there shall be a concurrence box on the plans where the Utility Owner signs and accepts the Utility Relocation Plans as shown.
 - The Contractor shall prepare all engineering design, plans, technical specifications, cost estimates, and utility adjustment schedules required to perform the necessary utility relocations. The Contractor shall certify to the Department that the design package listed above has been reviewed and accepted by the each respective Utility Owner.
- i. The Contractor shall be responsible for collecting the following from each Utility Owner that is located within the project limits: Certified Utility Relocation Plans including a letter of "no cost" where the Utility Owner does not have a prior right; Utility Agreements, certificates of eligibility, including cost estimate and Utility Relocation plans where the Utility Owner has a property interest; Letters of "no conflict" where the Utility Owner's facilities will not be impacted by the Project.
- j. The Contractor shall be responsible for determining if the Department has agreed to pay for in-kind relocations according to any approved Utility-Aid assistance package for publicly (government) owned utilities found within the project's limits (See the Department's TOPPS Policy #6863-11 for additional information regarding Utility-Aid). If the Department has approved Utility-Aid; it is the Contractor's responsibility to assemble the necessary information including any Utility Agreements in a final and complete form and in such a manner that the Department may approve the submittals with minimal review. Failure to submit such required Utility Agreements prior to the

beginning of construction shall fully transfer the utility owner's obligations, as stated in the subject Utility-Aid assistance package, to the Contractor. Deductions to reimburse the Department for such obligations may be made from any current partial payment of the Lump Sum price.

- k. The Contractor shall review all Utility Relocation Plans and Utility Agreements and certificates of eligibility to ensure that relocations comply with the Departments "Utility Accommodation Policy and Standards Manual". The Contractor shall also ensure that there are no conflicts with the proposed highway improvements, and ensure that there are no conflicts between each of the Utility Owner's relocation plans.
- l. The Contractor shall compile, and submit to the Department all SUE deliverables, Utility Relocation Plans, SUE Utility Impact Analysis, Utility Adjustment Schedules, Utility Agreements, Utility Estimates, and Letters of "no conflict," as set forth above for the project. The Contractor is expected to assemble the information included in the Utility Agreements and Utility Relocation Plans in a final and complete form and in such a manner that the Department may approve the submittals with minimal review. The Contractor is expected to meet with the Department's District Utilities Office and the State Subsurface Utilities Engineer (or designee) for a SUE Kick-Off meeting within 30 days of the Notice to Proceed to gain a full understanding of what is required with each submittal. The Utility Owners shall not begin their Utility Relocation work until authorized in writing by the Department.
- m. Each Utility Agreement and Utility Relocation Plan submitted shall be accompanied by a certification from the Contractor stating that the proposed relocation will not conflict with the proposed highway improvement and will not conflict with another Utility Owner's relocation plan.
- n. Depending on the provisions stipulated in the Memorandum of Understanding (MOU – See Attached) between the Department and each Utility Owner the Contractor shall be responsible for one of the following construction activities:
 - The Contractor shall be responsible for coordinating the work of its subcontractors and the various Utility Owners. The resolution of any conflicts between Utilities and the construction of the project shall be the responsibility of the Contractor. No additional compensation shall be allowed for any delays, inconveniences, or damage sustained by the Contractor or its subcontractors due to interference from utilities or the operation of relocating utilities.
 - The Contractor shall be responsible for performing all utility removal, relocation, and adjustments required to accommodate the proposed project. This shall include any required inspection, permitting, testing and monitoring to ensure that the work is properly performed to the certified design package. The resolution of any conflicts between Utilities and the construction of the project shall be the responsibility of the Contractor. No additional compensation shall be allowed for any delays, inconveniences, or damage sustained by the Contractor or its subcontractors due to interference from utilities or the operation of relocating utilities.
- o. During the construction of the project, The Contractor shall designate, prior to beginning any work, a Worksite Utility Coordination Supervisor (WUCS) who shall be responsible for initiating and conducting utility coordination meetings and accurately recording and reporting the progress of utility relocations and adjustment work. Also, the WUCS shall prepare an Emergency Response Plan for the purpose of planning,

training, and communicating among the agencies responding to the emergency. The WUCS shall be the primary point of contact between all of the Utility companies, the Contractor and the Department. The WUCS shall recommend the rate of reoccurrence for utility coordination meetings and the Engineer will have the final decision on the regularity for utility coordination meetings. In no case will utility coordination meetings occur less than monthly until controlling items of utility relocations and adjustment milestones are completed. The WUCS shall contact each of the utility companies for the purpose of obtaining information including, but not limited to, a Utility Adjustment Schedule for the controlling items of utility relocations and adjustments. The WUCS shall notify the appropriate utility company and/or utility subcontractors and the Department of the status of controlling items of relocations and adjustment milestones as they are completed. The WUCS shall furnish the Engineer, for approval, a Progress Schedule Chart, immediately prior to beginning Construction unless otherwise specified, which includes the utility companies controlling items of work and other information in accordance with Section 108.03 or elsewhere in the Contract documents.

1. Qualifications

The WUCS shall be an employee of the Prime Contractor, shall have at least one year experience directly related to highway and utility construction in a supervisory capacity and have a complete understanding of the Georgia Utilities Protection Center operations, and shall be knowledgeable of the High-voltage Safety Act and shall be trained on the Georgia Utility Facility Protection Act (GUFPA). The Department does not provide any training on GUFPA but will maintain a list of the Georgia Public Service Commission certified training programs developed by other agencies. Currently the following companies offer approved GUFPA training programs:

Associated Damage Consultants
Phone: 706.234.8218 or 706.853.1362

Georgia Utility Contractors Association
Phone: 404.362.9995

Georgia Utilities Protection Center
Phone: 678.291.0631 or 404.375.6209

H B Training & Consulting
Phone: 706.619.1669 or 877.442.4282 (Toll Free)

The Prime Contractor is responsible for obtaining the GUFPA training for their employees.

Questions concerning the Georgia Public Service Commission GUFPA training program shall be directed to:

Georgia Public Service Commission
244 Washington St. SW
Atlanta, GA 30334-5701
404.463.9784

2. Ticket Status

During the utility coordination meetings the WUCS shall collect and maintain the Ticket Status information to determine the status of all locate requests within the project limits. This information will be used to assure those planning to use mechanized equipment to excavate or work within the project limits are prepared to begin work when they have reported or estimated beginning work. At points where the Contractor's or utility company's operations are adjacent to or conflict with overhead or underground utility facilities, or are adjacent to other property, damage to which might result in considerable expense, loss, or inconvenience, work shall not commence until all arrangements necessary for the protection thereof have been made.

3. Notice

The names of known utility companies and the location of known utility facilities will be shown on the Plans, or listed in the Subsurface Utility Engineering Investigation if performed or in the Special Provisions; and the WUCS shall give 24-hour notice to such utility companies before commencing work adjacent to said utility facilities which may result in damage thereto. The WUCS shall further notify utility companies of any changes in the Contractor's work schedules affecting required action by the utility company to protect or adjust their facilities. Notice to the utility companies by the Department of the Award of Contract, under Subsection 105.06, shall not be deemed to satisfy the notice required by this paragraph. Furthermore, this 24-hour notice shall not satisfy or fulfill the requirements of the Contractor as stated in Chapter 9 of Title 25 of the Official Code of Georgia Annotated, known as the "Georgia Utility Facility Protection Act".

4. Agenda

The WUCS shall cooperate with the companies of any underground or overhead utility facilities in their removal and relocations or adjustment work in order that these operations may progress in a reasonable manner, that duplication of their removal and relocations or adjustment work may be reduced to a minimum, and services rendered by those parties will not be unnecessarily interrupted. To promote this effort the WUCS shall prepare an agenda for the utility coordination meetings and circulate same in advance of the meeting to encourage input and participation from all of the utility companies. The agenda shall be prepared by an examination of the project site and may include photographs of potential/actual utility conflicts.

5. Emergency Response Plan

The WUCS shall prepare and submit to the Department an Emergency Response Plan no later than 30 days prior to beginning construction. The WUCS shall clearly mark and highlight the gas, water and other pressurized pipeline shut-off valves and other utility services including overhead switch locations on the utility plans; and prepare a chart to indicate the location of each site (Street address or intersections), the utility company or operator of the facility with emergency contact information and the working condition of the device to facilitate prompt shut-off. The WUCS shall post the Emergency Response Plan in an area readily accessible to the Department. In the event of interruption to gas, water or other utility services as a result of accidental breakage or as a result of being exposed or unsupported, the WUCS shall promptly notify the appropriate emergency officials, the Georgia Utilities Protection Center and the appropriate utility facility company or operator, if known. Until such time as the damage has been repaired, no person shall engage in excavating or blasting activities that may cause further damage to the utility facility.

6. Submission

Provisions for reporting all utility coordination meetings, the progress of utility relocation and adjustment work milestones and ticket status information shall be reported on a form developed by the WUCS and shall be distributed by the WUCS to all of the utility companies as milestones are met and shall be included as part of the project records. These reports shall be delivered to the Engineer for review, on a monthly basis. The WUCS shall immediately report to the Engineer any delay between the utility relocation and adjustment work, the existing Utility Adjustment Schedule, or the proposed Utility Adjustment Schedule so that these differences can be reconciled.

7. Utility Adjustment Schedule

The purpose of the Utility Adjustment Schedule is to provide the Contractor with the pertinent information, including any utility staging required, dependent activities, or joint-use coordination that is required for the creation of a progress schedule chart that is feasible. A suitable Utility Adjustment Schedule form is available from the Department for the WUCS to circulate to utility companies for any proposed project construction staging. The WUCS shall submit the Progress Schedule Chart in accordance with Section 108.03 and the proposed Utility Adjustment Schedules from all utility companies to the Engineer for review and approval.

- p. At the time the Contractor notifies the Department that the Contractor deems the Project to have reached Final Completion, the Contractor shall certify to the Department that all Utilities have been identified and that those Utility Owners with property interests or other claims related to relocation or coordination with the project have been relocated or their claims otherwise satisfied or shall be satisfied by the Contractor.
 - q. The Contractor shall show the final location of all utilities on the as-built drawings for the project as stated in Section 999.3.A.7.
 - r. In addition to the above, the Contractor shall comply with all provisions set forth under subsection 107.21 of the Georgia Department of Transportation's Specifications, Construction of Transportation Systems, 2001 Edition.
 - s. The Contractor shall be responsible for determining if the Department has agreed to a Project Framework Agreement (PFA) with Local Government or, additional Specific Activity Agreements (SAA) within the project's limits (See the Department's TOPPS Policy #7120-3 for additional information). If the Department has approved a PFA or SAA; it is the Contractor's responsibility to assemble the necessary information including any Utility Agreements in a final and complete form and in such manner that the Department may approve the submittals with minimal review. Failure to submit such required Utility Agreements prior to the beginning of construction shall fully transfer the obligations, as stated in the subject PFA or SAA package, to the Contractor. Deductions to reimburse the Department for such obligations may be made from any current partial payment of the Lump Sum price.
5. **Right of Way:** All construction shall occur within the existing right of way and easement and/or required right of way and easement on parcels 1, 2, 3, 4, 5, 6, 7, 8, 9, 11 and 13. The Department is acquiring this right of way as part of P.I. No. 721850. Applicable sheets from the approved Right of Way Plans for P.I. No 721850 will be provided to the awarded Contractor. The Department will remove the building located on Parcel 9. The lake on Parcel 8 shall not be disturbed. Extreme care shall be taken to ensure that no fill, people or equipment enters the waters of the lake.

6. **Environmental:** The following pages include environmental commitments. Adhere and provide all material, labor, equipment and other incidentals required in the “Commitments/ Requirements” that apply to the Contractor. Key words such as “construction,” “contractor,” “work,” etc., point to the areas of responsibility by the Contractor.

The NEPA document for this project is a re-evaluated EA/FONSI. The Department is responsible for obtaining its review and approval from FHWA, and is also responsible for obtaining the necessary environmental permits on this project. The NEPA document has been approved. In addition, the IJR has been approved. The Contractor shall coordinate as soon as possible the design, utility relocation and construction schedule with the Department’s Office of Environment/Location who will use the information to secure all necessary environmental permits. Prior to ground breaking activities the Contractor shall provide the construction plans to the Department’s Office of Environment/Location who will re-certify the NEPA document. No ground disturbing activities shall take place until the NEPA document has be re-certified.

The Department’s Office of Environment/Location will review the Contractor’s preliminary plan set submission to verify impacts that the Department has tabulated. The tabulated impacts are based on the costing plans. If no significant changes exist between the preliminary plans and the costing plans, as determined by the Department, then the Department’s Office of Environment/Location will submit the Nationwide Permit (NWP) to the appropriate agency for review and approval after the preliminary plans have been reviewed. The Contractor shall provide to the Department, if requested, plan information and other information as necessary that will be used for supporting documentation in the NWP. If the Department determines that significant changes exist then the Office of Environment/Location will be required to revise the tabulated impacts prior to submitting the NWP. The Contractor shall allow the Department thirty (30) days to revise the NWP, and the Contractor shall allow sixty (60) days from the time the NWP is submitted to the appropriate agency and the NWP is reviewed and approved.

ENVIRONMENTAL COMMITMENTS/REQUIREMENTS

Project No.:	NH-056-1(52), CSNHS-0008- 00 (415)	404	Specialist Review <i>lw</i>
County:	Fulton	Air/Noise	<i>MA</i>
P.I. No.:	721850, 0008415	Archaeology	<i>aw</i>
Status:	Construction (unit 415 only)	Ecology	<i>pc</i>
Date Updated:	February 8, 2008	History	<i>mw</i>

COMMITMENT/REQUIREMENT	DOCUMENT STIPULATED IN	RESPONSIBLE OFFICE (Concurrence date; if other than OEL)	PLACE ON PLANS? (Yes or No)	REQUIRES A SPECIAL PROVISION? (Yes or No)	STATUS (Pre-Construction: Complete/ Incomplete) (During Construction: ECB Signature upon completion) (Post Construction: Complete/Incomplete)
------------------------	------------------------	---	--------------------------------	--	--

Pre-Construction Commitments

NH-056-1(52)-noise walls constructed under CSNHS-0008-00(415) would be replaced. Before NH-056-1(52) goes to construction context sensitive solutions for the noise walls along this corridor would be studied.	Reevaluation	Office of Environment/Location/Urban Design	Yes	No	Incomplete
NH-056-1(52)-All streams, and stream buffers as applicable, will be delineated on the plans.	Reevaluation	Office of Environment/Location	Yes	No	Incomplete
CSNHS-0008-00(415)-All streams, and stream buffers as applicable, will be delineated on the plans. Data transmitted to designers on 12/21/2007	Reevaluation	Office of Environment/Location	Yes	No	Complete
A 404 Nationwide 14 permit would be obtained due to 397 feet of stream impacts.	Reevaluation	Office of Environment/Location	No	No	Incomplete

ECB – Please Return Signed Green Sheet to OEL upon completion.

ENVIRONMENTAL COMMITMENTS/REQUIREMENTS

COMMITMENT/REQUIREMENT	DOCUMENT STIPULATED IN	RESPONSIBLE OFFICE (Concurrence date; if other than OEL)	PLACE ON PLANS? (Yes or No)	REQUIRES A SPECIAL PROVISION? (Yes or No)	STATUS (Pre-Construction: Complete/ Incomplete) (During Construction: ECB Signature upon completion) (Post Construction: Complete/Incomplete)
Mitigate for 397 feet of stream impacts by deducting 1,897 mitigation credits from a USACE-approved stream mitigation bank servicing HUC 03130001.	Reevaluation/Ecology Report	Office of Environment/Location and Office of Right-of-Way	No	No	Incomplete
Coordination with USFWS, under the Fish and Wildlife Coordination Act (FWCA), due to the extension of the culvert at Stream 1 for a distance of approximately 247 feet extension of and the culvert extension at Stream 2 for a distance of approximately 150 feet.	Reevaluation/Ecology Report	Office of Environment/Location	No	No	Complete
CSNHS-0008- 00 (415) and NH-056-1(52)-Special Provision 107.23G limits construction and demolition activities to a time (1 September to 31 March) when neotropical/migratory birds would not be breeding or utilizing nests under bridges/culverts and shall be implemented for barn swallow (<i>Hirundo rustica</i>) during project construction. This Special Provision will be transmitted to Design for inclusion in the construction contract	Reevaluation/	Office of Environment/Location	No	Yes	Complete
NH-056-1(52)-A landscape plan will be developed that would provide the affected property owners with a buffer zone. This plan will be developed prior to project implementation.	EA/FONSI	Office of Urban Design; Office of Right-of-Way	Yes	No	Incomplete
Final plan preparation and right-of-way acquisition may not proceed until the Atlanta regional Commission (ARC) is in agreement with the design	Letter from FHWA dated January 16, 1998	Office of Urban Design	No	No	Complete

ECB – Please Return Signed Green Sheet to OEL upon completion.

ENVIRONMENTAL COMMITMENTS/REQUIREMENTS

COMMITMENT/REQUIREMENT	DOCUMENT STIPULATED IN	RESPONSIBLE OFFICE (Concurrence date; if other than OEL)	PLACE ON PLANS? (Yes or No)	REQUIRES A SPECIAL PROVISION? (Yes or No)	STATUS (Pre-Construction: Complete/ Incomplete) (During Construction: ECB Signature upon completion) (Post Construction: Complete/Incomplete)
Construction may not proceed until the project is included in an updated conforming plan and TIP	Letter from FHWA dated January 16, 1998	Office of Urban Design	No	No	Complete

During Construction Commitments

Special Provision 107.23G limits construction and demolition activities to a time (1 September to 31 March) when neotropical/migratory birds would not be breeding or utilizing nests under bridges/culverts and shall be implemented for barn swallow (<i>Hirundo rustica</i>) during project construction.	Reevaluation	Office of Environment/Location	No	Yes	ECB Signature upon completion
CSNHS-0008- 00 (415)-Place orange fabric construction fencing, and erosion and sediment control measures as applicable, around the perimeter of all ESAs. These measures must be in place before any ground disturbing activities begin, including the relocation of utilities.	EA	Construction	Yes	Yes	ECB Signature upon completion
NH-056-1(52)-Place orange fabric construction fencing, and erosion and sediment control measures as applicable, around the perimeter of all ESAs. These measures must be in place before any ground disturbing activities begin, including the relocation of utilities.	EA	Construction	Yes	Yes	ECB Signature upon completion
NH-056-1(52)- Context Sensitive Noise barriers shall be constructed at Dunwoody Springs Drive area, Hollyfax Circle, Peachtree Dunwoody Court and Westfair Court areas, Talbot Colony area, Northgreen Drive, Wessex Court, Glenlake Parkway and Mabry Road. Barriers will be constructed in the beginning stages of project construction.	EA	Construction	Yes	Yes	ECB Signature upon completion

ECB – Please Return Signed Green Sheet to OEL upon completion.

ENVIRONMENTAL COMMITMENTS/REQUIREMENTS

COMMITMENT/REQUIREMENT	DOCUMENT STIPULATED IN	RESPONSIBLE OFFICE (Concurrence date; if other than OEL)	PLACE ON PLANS? (Yes or No)	REQUIRES A SPECIAL PROVISION? (Yes or No)	STATUS (Pre-Construction: Complete/ Incomplete) (During Construction: ECB Signature upon completion) (Post Construction: Complete/Incomplete)
CSNHS-0008- 00 (415)- Noise barriers shall be constructed at Glenlake Parkway area. Barriers will be constructed in the beginning stages of project construction.	EA	Construction	Yes	Yes	ECB Signature upon completion

Post Construction Commitments

The Department will conduct a post construction noise assessment.	EA/FONSI	Office of Environment/Location	No	No	Incomplete
---	----------	--------------------------------	----	----	------------

ECB – Please Return Signed Green Sheet to OEL upon completion.

999.2 PLANS

The Plans Package prepared by the Department includes multiple resources listed below. They will be made available to the short listed Design-Build Teams via a read only GDOT FTP site. These resources are to be used in preparing the bid and corresponding technical proposal (refer to Special Provision Section 102—Bidding Requirements and Conditions) for this project unless otherwise noted as “For Information Only.” The Contractor shall make the Department aware on any resource that is in error or would cause the design (in the Plans Package) to not be constructible.

Those items labeled as for information only are not part of the plans and specifications or contract for this Project. The Georgia Department of Transportation, in making this information available to contractors, assumes no responsibility for its accuracy. No claim will be considered if the contractor relies on this information in its bidding or in its construction operations and finds that it is inaccurate. The Contractor’s attention is directed to Specifications 101.16 – CONTRACT and 102.05 – EXAMINATIONS OF PLANS, SPECIFICATIONS, SPECIAL PROVISIONS, AND SITE OF THE WORK.

1. Costing Plans consisting of:
 - a. Preliminary Construction Plan Layout
 - b. Preliminary Alignments and Profiles
 - c. Best-fit Alignment of SR 400
 - d. Proposed Typical Sections
 - e. Preliminary Cross Sections
 - f. Preliminary Wall Envelopes
 - g. Preliminary Bridge Plans
2. Concept Report
3. Interchange Justification Report
4. Environmental Document
5. CAiCE Data – For Information Only
6. Microstation J File – For Information Only
7. Design Variances
8. Bridge Foundation Investigation Report – For Information Only
9. Soils Survey Report – For Information Only
10. Wall Foundation Investigation Report – For Information Only
11. Pavement Structures
12. Overhead/Subsurface Utility Engineering Investigation Plans for quality level “B” (See Section 999.3.B.1.s for details)
13. Costing Plan Review Report
14. The Department’s initial outline of the Traffic Management Plan

A soil survey, BFI and WFIs are included for this project for information only. Please note that stationing of actual locations of borings may vary slightly since they were obtained before the alignments and structure locations had been finalized.

Items 2-14 above are available for download at the GDOT FTP site. The Contractor shall be responsible for periodically monitoring the site for updates. The GDOT FTP site may be accessed two ways:

1st Access to the FTP site through the internet:
<ftp://dotpublic:dotoutside02@ftp.dot.state.ga.us/>

2nd Access to the FTP site through the FTP program:

Username: dotpublic

Password: dotoutside02

Host Name: <ftp.dot.state.ga.us>

The files are located at </DOTFTP/UrbanDesign/0008415/>

The information that will NOT be provided by the Department in the RFP package, and that the Contractor shall be responsible for, includes, but is not limited to:

- a. Complete Survey Database and DTM
- b. Drainage design or sizing, drainage calculations, drainage profiles, drainage cross sections, required culvert and pipe extensions or any information related to required drainage
- c. Signing and marking plans including interstate signage and overhead sign structure requirements
- d. Signal plans (2 signal upgrades for Barfield Rd at Hammond Dr and for West Concourse Prkway/Ramp N2 at Hammond Dr; 1 new signal for Ramp SR1 at Hammond Drive)
- e. A TE study and signal permits are required
- f. Maintenance of traffic plans
- g. Erosion Sedimentation and Pollution Control Plans
- h. Notice of Intent (NOI)
- i. Sound barrier plans and envelopes

999.3 DESIGN

A. General

1. **Measuring Units:** The project shall be designed in **English** units of measurement.
2. **Design Software:** Microstation and CAiCE software are required. On completion of the Project, a complete as-built set of plans shall be provided to the Department in the following formats: two (2) sets of CD-ROMs with all electronic design files, design notes and calculations; one (1) set of full-size mylar reproducible; one (1) full-size set of paper prints; and one (1) half-size set of paper prints. In addition, paper prints shall be required throughout the design period for the Department's reviews as noted herein. All files are to conform to the criteria found in the most current version of the Department's Electronic Data Guidelines (EDG). This information can be found at the Department's web site: <http://www.dot.state.ga.us/dot/preconstruction/adds/edg/index.shtml>.
3. **Design Scope of Services:** Plans shall be prepared in accordance with the Georgia Department of Transportation's instructions as to design criteria, procedures, and format as contained in this Special Provision and the following: Current Manual on Uniform Traffic Control Devices; Current Draft Georgia Manual on Drainage Design for Highways; Current Utility Accommodation Policy and Standards Manual; GDOT Bridge Design Memos and the Bridge and Structural Design Manual; and the Department's Current Plan Preparation Guide (PPG). Project designers shall adequately consider all elements of the design, including but not limited to roadway geometry, drainage requirements, traffic control during construction, erosion control, structural design, utility conflicts, signing and marking, and future maintenance requirements. Roadway lighting will not be required.
4. **Design Reviews:** The design is to be prepared under the direct supervision of licensed design professionals. A Professional Engineer licensed to practice engineering in the State of Georgia on the design team shall seal the final plans. Their seal on the drawing shall

represent certification that the design meets all applicable codes and is of good engineering practice and standards. It shall be the responsibility of the Contractor to check and certify the design.

The Department may establish dates and times for cursory reviews and may comment on design work, but will not require hold points, review periods, or comment responses, except noted otherwise. If at any time the Department determines that the design work is not in conformance with the Department's standards, specifications, or good engineering practice, the Department reserves the right to stop work, at the Contractor's expense until a resolution of the issue(s) has occurred. Monthly progress meetings are to be held for the duration of the project. The Contractor shall provide a conference call number for all monthly meetings with the intent to allow other Offices within the Department to actively participate in the discussion.

Construction documents (plans and specifications) relating to the construction phases shown in Table A-1 will be submitted to the Department for review and approval. Approvals, disapprovals, or comments made by the Department will be provided in writing to the Contractor within the appropriate timeframes shown in the table A-1. No construction is to begin on any phase of the work prior to receiving approval of the plans for that phase from the Engineer. Other items shall be submitted to the Department by the Contractor if requested. After the Department has approved the plans for construction the Contractor is required to submit to the Department a request for any subsequent plan/design changes and include any necessary documentation. The Department must approve the requested change prior to its implementation on construction.

TABLE A-1: REVIEWS

Submittal Description	Format	Quantity	Delivery Date*	Review Period*	Review Type	Comment
Basis of Design	HC	6	NTP+7	14	Accepted by Engineer	
Schedule – including review times	MS Project or Primavera	6	NTP+14	14	Accepted by Engineer (includes Design Liaison and Construction Manager)	Also provide a copy to OEL.
QC/QA Plan	HC	6	NTP+14	14	Accepted by Engineer	See 999.3.A.6.
Preliminary Roadway Plans	HS	6	PAS	21	Accepted by Engineer	Provide one copy to OEL for review.
Signing and Marking (Preliminary & Final)	FS,HS	3,3	PAS	21	Accepted by Engineer	Incl Overhead Sign details. Also reviewed by TMC.
Traffic Management Plan	HC	3	PAS	21	Accepted by Engineer	FHWA will review.
Signalization Plans (Preliminary & Final), TE Study and Traffic Signal Permits	FS,HS	3,3	PAS	30	Accepted by Engineer	Also reviewed by TMC.
Preliminary Structures <ul style="list-style-type: none"> • Bridge Layouts 	FS,HS,HC,PDF	3,3,1,1	PAS	30	Accepted by Engineer	Only submitted if Contractor proposes alternate design approach, see Section 999.3.C.3.A. FHWA reviews will be concurrent.
Preliminary Structures <ul style="list-style-type: none"> • Wall Layouts 	FS,HS,HC,PDF	3,3,1,1	PAS	30	Accepted by Engineer	
50% Structures <ul style="list-style-type: none"> • Bridge Plans 	FS,HS	3,3	PAS	30	Accepted by Engineer	FHWA reviews will be concurrent.
100% Structures <ul style="list-style-type: none"> • Bridge Plans • Wall Plans 	FS,HS	3,3	PAS	30	Accepted by Engineer	FHWA reviews will be concurrent.

TABLE A-1: REVIEWS (Continued)

Submittal Description	Format	Quantity	Delivery Date*	Review Period*	Review Type	Comment
Erosion Sedimentation and Pollution Control Plans	FS,HS	3,3	Contractor Resp.	21	Accepted by Engineer	Completed NOI and Erosion Plan Certification Statement to be provided by the Contractor to the Department. Department to file NOI.
Final Construction Plans	FS,HS	3,3	PAS	21	Accepted by Engineer.	A copy shall also be provided to OEL who will re-certify the NEPA document. FHWA reviews will be concurrent.
All plan revisions	FS, HS	3,3	Per occurrence	14	Accepted by Engineer	

TABLE A-1: REVIEWS (Continued)

Submittal Description	Format	Quantity	Delivery Date*	Review Period*	Review Type	Comment
Utility Plans/Agreements	Plans/Agreements	Agreements: 3 hard copy, 1 electronic pdf Plans: 1 for each Utility Owner + 3 for Dept. and Microstation files	Concurrently w/ Construction Traffic Control Plans	Agreements: 30 days for Dept. + 120 days for each Utility Owner Plans: 30 days	Relocation Plans and Agreements reviewed by Department Utilities Office. Agreements also reviewed by Utility Owner.	
Preliminary Utility Status Report	Report	3	NTP + 120	21	Accepted by Engineer	
Relocated Utility Plans	HS	Plans: 1 for each Utility Owner +3 for Dept. and Microstation files	Concurrently w/ Construction Traffic Control Plan	21	Accepted by Engineer	
Overhead/Subsurface Utility Engineering (SUE) Investigations - all deliverables	MS FS,HS	Electronic SUE files, mapping files and proposed design files 1 District DUO, 1Engineer	Due 45 days after Control of Soil Erosion and Sedimentation Plan	30	Reviewed by District Utilities Office (DUO) Accepted by State Subsurface Utilities Engineer	
SUE Utility Impact Analysis	AR, report	3	NTP + 180	30	Reviewed by District Utilities Office (DUO) Accepted by State Subsurface Utilities Engineer	
Construction Traffic Control Plan	FS,HS	3,3	As needed	21	See Specification 150	
Shop Drawings	FS	5	PAS	30	Accepted by Engineer	
As Built Plans	FS	See spec	Project Completion (-30)	30	Accepted by Engineer	
Progress Meetings / Reports	HC	TBD	TBD	TBD	Accepted by Engineer	Meetings may be more frequent as required by the Engineer or by the Contractor.

TABLE A-1: REVIEWS (Continued)

*All days are "Calendar Days."

All Submittals shall be made directly to the Engineer. The Engineer shall provide submittals to applicable GDOT Office Reviewer and/or other applicable entities (including FHWA and local governments) as directed by the Engineer. As approved by the Engineer the Contractor may provide submittals to applicable offices for a concurrent review. **The Contractor shall hand-deliver submittals, track and regularly update the Engineer on review status.** In the event that concurrent submittals are required, the "receipt" date shall be the date the last recipient receives the submittal and shall be the contractual begin date for the review. Unless a different review time is specified elsewhere in the contract, a period of **thirty (30) calendar days** from receipt to release of the submittal by the Department shall be allowed for the Department's review. Engineer acceptance is required for all reviews. All Contractors' schedules shall reflect the review times contained within the specifications and contract. Engineer's receipt of submittals will mark the beginning of the review period. All submittals by the Contractor shall be required to contain a statement certifying that no unapproved design-exceptions have been incorporated in the submittal. Up to date half-size sets of plans with the most current design and construction plans shall be made available to a distribution list made up of up to 20 individuals/offices at all times during this project. Errors and omissions are the responsibility of the Contractor to correct and shall be at the Contractor's expense.

AA	As Appropriate
AE	Accepted by Engineer
AR	As Required
c	Calendar Days
FS	Full-size paper – meets GDOT Plan Presentation Guide
HC	Hard Copy – 8 ½ x 11 unless otherwise noted
HS	Half-size paper – meets GDOT Plan Presentation Guide
m	Month = 30c
Monthly	Submitted monthly not later than the number of days at the end of that report month
MS	Microstation File - Electronic
MW	Microsoft Word - .doc
NTP	Notice to Proceed
PAS	Per Approved Schedule
PDF	Adobe PDF – One complete file
PDFI	Adobe PDF – Individual Sheets

Monthly progress meetings shall be held on site. Attendees shall include the Contractor, design consultant, the Department's project engineer and design liaison, and may also include a representative from various Department Offices.

5. Field Surveys: The Contractor shall verify all provided survey data. The Contractor is to provide terrain and drainage cross sections, pavement elevations, and drainage structure information for this project. All survey data shall be noted in English units. The following is only a guideline for data collection and is not intended to be comprehensive:

- a. Provide cross sections of the terrain and pavement at mainline stations as follows:
 - (1.) These cross sections shall be provided at intervals adequate enough to accurately design and construct the Project, but not to exceed 100 feet.
 - (2.) The cross sections are to extend from the centerline to the existing right of way line.
 - (3.) In addition to all terrain breaks, the cross sections shall include all applicable edges of pavement (emergency, outside edges of travel lanes, and curb and gutter sections).
- b. Use the Department feature codes when collecting the data in accordance with CAiCE Survey Data Guidelines, current version at time of advertising.
- c. Locate all existing mainline drainage structures (X,Y, and Z) within the right of way and provide their size, type, condition, and flow line elevations at each end.
- d. Gather inlet elevations for all drop inlets and catch basins.
- e. Develop terrain profile at each drainage structure showing the skew of the structure.
- f. Develop terrain profile of the drainage outfall from the end of each structure to the right of way.
- g. Provide any additional necessary survey control.
- h. Stake centerlines.
- i. Prepare Survey control Packet.
- j. Perform sign surveys
- k. Perform bridge surveys
- l. Perform surface utility surveys
- m. Perform supplemental topo surveys
- n. Perform right of way surveys
- o. Perform stream surveys
- p. Perform surveys of ITS items
- q. The accuracy for all survey data shall be as follows:

Horizontal: Additional control	=	1:10,000
Topography:	=	0.4'
Vertical: Additional control	=	NOAA 3 rd Order
Pavement:	=	0.03'
Ground Terrain:	=	0.25'

6. Quality Control/Quality Assurance for Design: The Department, except where noted otherwise, will have oversight responsibilities only and will not perform official reviews and approvals of design work. The Department will not take any approval or formal review actions on design issues except as noted herein or for deviations from the intended scope of the project.

The Contractor is to employ only persons duly registered in Georgia in the appropriate category in responsible charge of supervision and design of the work; and further, shall employ only qualified, State of Georgia registered land surveyors in responsible charge of any survey work.

The Contractor shall use only a consultant design team that is prequalified by the Department in all applicable area classes for this Contract (see Section 999.1.A.2). Approval of any replacements within the team shall occur prior to the letting of the project. Failure to secure approval of the replacements prior to letting may result in the disqualification of the Contractor's bid.

The Contractor shall endorse all final reports, contract plans and survey data. These endorsements shall be made by a person(s) duly registered in the appropriate category by the Georgia State Board of Registration for Professional Engineers and Land Surveyors, being in the full employ of the Contractor and responsible for the work prescribed by this agreement.

Authorized representatives of the Department and Federal Highway Administration may review and inspect the Project activities and data collected at all times. All reports, drawings, studies, specification estimates, maps and computations prepared by or for the Contractor shall be available to authorized representatives of both the Department and the Federal Highway Administration for inspection and review in the General Office of the Department or at another location as determined by the Department. The Department's review comments are to be incorporated into the plans by the Contractor or as agreed. These changes shall not result in an increase in cost.

Before the start of the contracted design effort, the Contractor shall develop and acquire the Department's approval for a QC/QA Plan to ensure that all design documents are prepared in accordance with the Department's Plan Presentation Guide (www.dot.state.ga.us, search for keyword "PPG") using good, prudent and generally accepted design and engineering practice. Also see the Manual of Quality Standards for Consultant Services with the Georgia Department of Transportation.

The QC/QA Plan shall include the following:

- a. Quality control and quality assurance procedures for design documents shall specify measures to be taken by the Contractor (A) to ensure that appropriate quality standards are specified and included in the design documents and to control deviations from such standards, being understood and agreed that no deviations from such standards shall be made unless they have been previously approved by the Department, and (B) for the selection of suitable materials and elements of the Work that are included in the Project.
- b. Quality control and quality assurance procedures for preparing and checking all plans, calculations, drawings and other items submitted ensure that they are independently checked and back-checked in accordance with generally accepted engineering practices, by experienced engineers. The originator, checker and back-checker shall be clearly identified on the cover of all submittals. Specific procedures for verifying the computer programs used shall be included as well. Plans, reports and other documents shall be stamped, signed and dated by the responsible Georgia registered engineer where required under the contract documents, generally accepted engineering practices or by applicable laws. It is required that the Contractor also submit a statement that all reviews have been completed.
- c. Procedures for coordinating work performed by different persons within the same area, in an adjacent area or in related tasks shall ensure that conflicts, omissions or misalignments do not occur between drawings or between the drawing and specifications. These procedures shall also allow for the coordination of the review, approval, release, distribution and revision of documents involving such persons.

All the persons proposed to be responsible for design Quality Control and Assurance are to be listed as follows:

- Discipline
- Name
- Qualifications
- Duties
- Responsibilities
- Authorities

All key personnel performing Quality Control and Assurance functions shall be exclusively designated as such and shall not be assigned to perform conflicting duties.

All documents are to be maintained by the Contractor for the duration of the Contract and shall be organized, indexed and delivered to the Department (1) upon Final Acceptance or (2) even if incomplete, within seven (7) days of receipt of request from the Department. These documents shall include, but not be limited to, the following items: design criteria, reports and notes, calculations, drawings, schematics, supporting materials, statement regarding accomplishment of reviews and others.

7. **As-Built Plans:** Upon completion of the Project, a complete as-built set of plans shall be provided to the Department in the following formats:
- A. Two (2) sets of CD-ROMs with all electronic design files.
 - B. Design notes and calculations.
 - C. Entire set of plans in one .pdf file and .tif file (per sheet).
 - D. One (2) full-size set of paper prints.
 - E. One (1) half-size set of paper prints.

In addition, paper prints will be required throughout the design period for the Department's reviews as noted herein. The Contractor shall be responsible for all production and delivery of materials needed for Department review. Note materials required by other state agencies will be covered similarly by the Contractor. A member of the design team who is a Professional Engineer licensed to practice engineering in the State of Georgia shall seal the as-built plans. An estimated summary of quantities and detailed estimate shall be provided in the final as-built plans.

8. **Ownership of Documents:** The Contractor agrees that all reports, drawings, studies, specifications, survey notes, estimates, maps, computations, computer files and other data, prepared by or for it under the terms of this agreement shall be delivered to the Department to become and remain the property of the Department upon termination or completion of the work. The Department will have the right to use this information without restriction or limitation and without compensation to the Contractor other than that provided for in this agreement.

Any use of these documents by the Department on any project other than this one will be done without warranty by the Contractor.

9. **Insurance:** In addition to the insurance requirements covered elsewhere in this Proposal, the Contractor shall have insurance coverage of the following types and amounts:

- a. Valuable Papers: Insurance in an amount sufficient to assure the restoration of any plans, drawings, field notes or other similar data relating to the work covered by the project is required. Insurance is to be maintained in full force and effect during the life of the agreement.
- b. Professional Liability (Errors and Omissions): Insurance in an amount not less than one million dollars (\$1,000,000) per claim (with a maximum of \$250,000 deductible per claim) during the agreement term and for a period of at least five (5) years after the agreement is closed is required. Such a policy is to cover all of the Contractor's professional liabilities, whether occasioned by the Contractor, his employees, subcontractors or other agents, arising out of services performed under or in accordance with this agreement.

10. Publication and Publicity: Articles, papers, bulletins, reports or other materials reporting the plans, progress, analyses or results and findings of the work conducted under this Agreement shall not be presented publicly or published without prior approval in writing from the Department. All releases of information, findings and recommendations shall include a disclaimer provision to be included in all published reports on the cover and title page in the following form:

“The opinions, findings and conclusions in the publication are those of the author(s) and not necessarily those of the Department of Transportation, State of Georgia or the Federal Highway Administration.”

Any information concerning the project, including conduct, results or data gathered or processed, released by the Contractor without prior approval from the Department will constitute grounds for termination of this Agreement without indemnity to the Contractor. Information released by the Department or by the Contractor with prior written approval is to be regarded as public information and no longer subject to the restrictions of this Agreement. Information required to be released by the Department under the Georgia Open Records Act, Section 50-18-70, et seq., O.C.G.A., the restrictions and penalties mentioned set forth herein shall not apply. Any request for information directed to the Contractor, pursuant to the Georgia Open Records Act, by the public is to be redirected to the Department for further action.

11. Copyrighting: The Contractor and the Department agree that any papers, interim reports, forms and other material which are a part of work under this Agreement are to be deemed a “work made for hire”, as such term is defined in the Copyright Laws of the United States. As a “work made for hire”, all copyright interests in said works shall vest in the Department upon creation of the copyrightable work. If any papers, interim reports, forms or other material which are a part of work under the Agreement are deemed by law not to be a “work made for hire”, any copyright interests of the Contractor are hereby assigned completely and solely to the Department. Publication rights to any works produced under this Agreement are reserved by the Department.

12. Patent Rights: If patentable discoveries or inventions shall result from work described herein, all rights accruing from such discoveries or inventions shall be the sole property of the Contractor. However, the Contractor agrees to and does hereby grant to the Department, an irrevocable, non-exclusive, non-transferable and royalty-free license to practice each invention in the manufacture, use and disposition according to law of any article or material and in use of any method that may be developed as a part of the work under this Agreement.

B. Roadway

1. Preparation of Construction Plans

- a. **Criteria:** The Contractor is to become familiar with and use the most current, as determined by the Department, American Association of State Highway and Transportation Officials (AASHTO) Design Manuals for Arterial Streets, Rural, Urban and Interstate Highways, including those standards adopted by the AASHTO and approved by the Secretary of Commerce, as provided by Title 23, United States Code, Section 109 (b), with the Department's Standards, Procedures, Plans, Specifications and Methods, with Federal Highway Administration procedures relating to plan review and approval, and shall produce plans in accordance therewith. The Project is to be designed and constructed utilizing guidelines found in the American Association of State Highway and Transportation Officials (AASHTO) Design Manuals for Arterial Streets, Rural, Urban and Interstate Highways (including but not limited to the "Green Book"), unless otherwise approved by the Department.
- b. **Design Specifications and Guidelines:** Design for roadways and intersections shall be in accordance with the current edition of AASHTO Design Specifications; AASHTO Standard Specifications for Structural Supports for Highway Signs, Luminaries and Traffic Signals; and AASHTO Roadside Design Guide and the Department of Transportation Standard Specifications for Construction of Roads and Bridges, 2001 Edition, and current editions of Special Provisions. Design and plan preparation shall also be in accordance with the FHWA Federal-Aid Policy Guide. Plan and specifications shall conform to the requirements of the Highway Capacity Manual, current edition (T.R.B. Report No. 2). Design work for inside interstate rights of way shall conform to the interstate standards. Design for work outside interstate right of way shall conform to AASHTO design standards for the appropriate classification and speed design. Any deviation from those already approved shall also require a written design exception or variance to be approved prior to incorporating it into the work. The Contractor shall prepare the required design exception request for approval by the Department and/or the FHWA. A design exception request shall justify fully why the guideline cannot be reasonable met considering such items as right of way impacts, cost, mitigation measures taken, and accident history and shall include the recommendation. The Contractor shall meet the current ADA guidelines. In addition to the references listed above, the following references shall be used in the development of this project:
- Electronic Data Guidelines (EDG) – current version at time of advertising
 - Plan Presentation Guide (PPG) – current version at time of advertising
 - GDOT Design Policy Manual – current version at time of advertising
 - Manual on Uniform Traffic Control Devices "MUTCD" by the U.S. Department of Transportation, Federal Highway Administration "FHWA" – current version at time of advertising
 - Draft Manual of Drainage Design for Highways by the Georgia Department of Transportation - current version at time of advertising
 - Roadway and Bridge Standard Plans as of July, 2006 by the GDOT Road and Airport Design Office. Design and plan preparation shall also be in accordance with the Certification Acceptance authorized by 23 USC 117(a) for Administering Federal Aid Projects Not On Interstate System, dated June 1, 1990.
 - Guidelines for Processing Design Data in CAiCE – <http://www.dot.state.ga.us> – search for keyword "CAiCE" - current version at time of advertising.
 - Construction Details by the GDOT Road and Airport Design Office - current versions at time of advertising
 - Pay Item Index by the GDOT State Transportation Office Engineer - current versions at time of advertising
 - Utility Accommodation Policy and Standards by the GDOT Utilities Office - current version at time of advertising

This List is not intended to be all-inclusive. All references are to be the current editions accepted by the GDOT and in effect at time of advertising. Any current editions that are written in metric units shall be "soft converted" to U.S. Standards Units. Any rounding shall be to the dimension that shall increase safety.

- c. **Plan Sizes:** Plans for roadway, drainage and utilities shall be reproducible quality ink drawings on bond paper. They shall have outside dimensions of 36" by 24" with a 2" margin on the left and a 1/2" margin elsewhere and be produced by a Microstation CADD system. Review sets of plans may be on paper with the same dimensions as above.
- d. **Construction Plan Requirements and Scale:** The Plans shall be fully dimensioned in English units; all elevations necessary for construction shall be shown similar to the Department's normal practice. All plans are to be prepared on the scales listed below, unless otherwise approved by the Department. Drawings and lettering shall be such as to produce clear and legible reproductions when reduced to half-size. The scale of sheets are to be as follows:
 - (1.) 1" = 10'
 - (a) Roadway cross sections 1" = 10' horizontal and 1" = 10' vertical
NOTE: Cross sections may have to be plotted lengthwise on the sheet to avoid folded sections
 - (b) Staging cross sections 1" = 10' horizontal and 1" = 10' vertical
NOTE: Cross sections may have to be plotted lengthwise on the sheet to avoid folded sections
 - (2.) 1" = 20' (Please note the Costing Plans are shown at 1" = 50', however final approved plans shall be 1"=20')
 - (a) Roadway plan sheets for interstate type projects
 - (b) Roadway profile sheets for interstate-type projects 1" = 50' horizontal and 1" = 10' vertical
 - (c) Drainage profile sheets 1" = 50' horizontal, 1" = 10' vertical (include location of existing and proposed utility crossings.)
 - (d) Staging plans for interstate projects
 - (e) Bridge plan and elevation sheet
 - (f) Utility relocation plans
 - (3.) 1" = 100'
 - (a) Stake out sheet
 - (4.) 1" = 400' or 500'
 - (a) Cover sheet
 - (b) Drainage area map

The Contractor shall check all details and dimensions shown on the plans before they are submitted to the Department for review. Topography shall remain fully legible when plans are reduced in size, but shall be less prominent and readily distinguishable from the proposed work. Profile sheets shall have the existing ground line dashed and the required profile in a solid line. All other plan sheets (utility, erosion control, lighting, signing & marking, signal, etc.) shall be the same scale as its corresponding roadway plan sheet.

- e. **Construction Plans Organization and Sheet Index:** Construction plans shall be assembled according to the Department's Electronic Data Guidelines (EDG), current version at time of advertising.

The total sheets shown in the Index shall be the total number of sheets in the plans. The total sheets shown in the upper right hand corner of each sheet shall be the total number of sheets submitted for the final plan submission. Any preliminary plans shall be assigned temporary sheet numbers by using the sequence prefix followed by a two-digit number per the Electronic Data Guidelines (EDG). These numbers are to be placed in small blocks in the lower right corner of the sheet.

- f. **Computations:** All design computations and computer printouts shall be neatly recorded on 8 ½" by 11", fully titled, numbered, indexed, dated and signed by the designer/project manager and checker. Project quantity computations shall be done in electronic spreadsheet format or directly processed from the CAiCE software. The computer files and two copies of the computations fully checked and appropriately bound, shall be submitted to the Department with the plans. A complete tabulation of the drainage analysis along with the calculations used to determine the size of drainage structures shall be submitted to the Department with the construction plans.
- g. **Plan Print Requirements:** The Contractor shall furnish all the prints necessary for the development of the preliminary and final construction plans and specifications. All prints shall be clear and legible.
- h. **Supplementary Information on Construction Plan Preparation:** All of the following sheet descriptions and others required for completeness of the plans shall conform to the Department's Plan Presentation Guide.
- i. **Traffic Flow Diagrams:** These sheets provide the traffic data information to determine design criteria. The Contractor shall use traffic volumes provided in the SR 400/Hammond Drive Interchange Design / Build Request for Proposals information package to prepare the Traffic Flow Diagram sheets. The sheets are not required to be to a scale, but the drawing shall show and represent the alignment of the overall project. Two sets of diagram shall be prepared, one which shows the Average Daily Traffic (ADT) and the other showing the peak Design Hourly Volumes (DHV).
- j. **Typical Sections:**
 - (1.) Typical sections shall show exact dimensions (medians, travel-lanes, shoulders, slopes, ditches, etc.) from the construction centerline. Locate and label the roadway profile grade line for both existing and proposed. Label appropriate items as to type and thickness. All slope controls shall be specified on each typical section. Preliminary typical sections are being provided by the Department in the Costing Plans.
 - (2.) Typical sections shall indicate the spread rates for Asphaltic Concrete and thickness for Graded Aggregate Base to be used on the project. The pavement structures described in the typical sections are those already approved by the Department.
 - (3.) Any special conditions shall be shown as details on the typical section sheets. However, if these items are covered by a Georgia Standard or a construction detail, then a note shall be included referring to the standard or detail.
 - (4.) The scale of each typical section may differ between the horizontal and the vertical in order to more clearly show the division between separate layers of the structure of the pavement.
 - (5.) Roadway plans shall meet the posted speed design within the limits of this project as shown in the 2002 Roadside Design Guide and the MUTCD.
 - (6.) Any substandard guardrail within the limits of construction is to be replaced under this contract. Where construction exists only on one side, only the guardrail on the construction side adheres to this requirement.
- k. **Construction Plan Sheets:** Construction plan sheets shall be in accordance with the Plan Presentation Guide including, but not limited to, the following: existing topography, construction centerline, curve data, edge of pavements, medians, drainage, bridges, and project limits.

- l. **Roadway Profile Sheets:** The roadway profiles shall be in accordance with the Plan Presentation Guide including, but not limited to, the following: existing ground line, existing elevations , proposed ground line, proposed elevations, PVC, PVT, PVI, LVC, K Value, high points, low points, existing structures, and proposed structures.
- m. **Staging Plan Sheets:** Staging plan sheets shall be in accordance with the Plan Presentation Guide including, but not limited to, the following: existing topography, construction centerline, curve data, edge of pavements, medians, drainage, bridges, and project limits
- n. **Staging Profile Sheets:** The staging profiles shall in accordance with the Plan Presentation Guide including, but not limited to, the following: existing ground line, existing elevations , proposed ground line, proposed elevations, PVC, PVT, PVI, LVC, K Value, high points, low points, existing structures, and proposed structures.
- o. **Drainage Profile Sheets:** Drainage profiles shall be shown for all proposed drainage structures except side drains. Existing drainage profiles shall be shown if pipe and structures are to be retained and when a proposed drainage system connects to it. Drainage structures shall be fully detailed and dimensioned.

All cross drain structures shall be sized by the P.C. computer program HY-8. The Allowable Highwater shall be the existing 100-year elevation plus 1.0 foot.

All drainage structures located in a designated floodway shall be sized to comply with FEMA regulations. FEMA structures require the computer analysis from FEMA, usually HEC-2 analysis. Remodel the floodway and do not increase the 100-year storm more than 1.0 foot total. If the floodway is altered, all the necessary maps and computer printouts shall be included in the drainage analysis and the Contractor shall ensure that all FEMA and Local Government requirements are satisfied. When changing sizes of pipes, the top elevation of the pipes shall be the same and the flow lines shall change. All other guidelines and computation sheets are in the “Draft Manual on Drainage Design for Highways”. The Contractor shall submit all final drainage computations.

- p. **Sound Barrier Envelopes and Plans:** Sound barrier envelopes and plans sheets shall be in accordance with the Plan Presentation Guide (PPG) and current Department practices. Sound barrier envelopes will be reviewed by the Office of Urban Design. Shop drawings will be reviewed by the Office of Bridge and Structural Design.
- q. **Erosion and Sediment Control Sheets:**

Note: The Contractor shall not begin work until the Control of Soil Erosion and Sedimentation Plan has been accepted and approved by the Engineer. See 999.1.A.2 and Specification 161.

All Erosion Sedimentation and Pollution Control Plans (ESPCP) being prepared for the April 2007 letting and thereafter shall be revised or prepared in accordance to the interim guidelines for Erosion Sedimentation and Pollution Control Plans, in accordance with Bradley Ehrman’s correspondence dated January 8, 2007. This guidance supersedes all previous instructions with regards to development of the ESPCP.

Erosion and Sediment Control Plans detail the temporary erosion control devices to be used during construction. These devices include, but are not limited to, sediment traps, silt control gates, floating silt retention barriers, check dams, silt fence (types A, B & C), bailed straw ditch checks, brush barriers and slope drains. Additional plan sheets are required for each stage of construction. The criteria listed below shall be required as a minimum for the plans:

Item Title	Includes / Comment
Erosion and Sediment Control Cover Sheet	<ul style="list-style-type: none"> • Project Description • Certification Statements • Project information • Note: Shall be signed by GDOT Chief Engineer
General Notes	Miscellaneous Statements
Drainage Area Map	<ul style="list-style-type: none"> • Runoff Coefficients – before & after • Peak Flow – before & after • Drainage Patterns – flow arrows • Delineated Wetlands • Drainage to lakes within ½ mile • Disturbed Area • Pipe Sizes • Construction Limits
Best Management Practices	Actual Plans – including erosion and sediment control for any staging plans
NOI Form	Current NOI form and will be provided to successful Contractor by the Department after review and approval of erosion control

Note: Sediment and Erosion Control Items shall be paid for under CONSTRUCTION COMPLETE.

Fill Slopes: Mats are to be used on all fill slopes for all heights that:

- (1.) Cross a drainage structure (*minimum of 50 feet on either side of the centerline of the drainage structure*)
- (2.) Adjacent to sensitive areas (i.e. wetlands, waterways, lakes, developed property)
- (3.) Are unusually difficult to maintain
- (4.) Are steeper than 2.5:1
- (5.) Are planted with permanent grass (*It is not the intent to use mats as temporary slope protection.*)
- (6.) Other conditions deemed appropriate by the Engineer

Cut Slopes: Mats shall be used on all cut slopes that:

- (1.) Are steeper than 2:1, regardless of height
- (2.) Are on slopes of highly erodible soils (*Erosion Index greater than 9*)
- (3.) Are adjacent to sensitive areas (i.e. wetlands, waterways, lakes, developed property)

Lake Sedimentation: Contractor's Responsibilities

- 1) A pre, mid-term and post construction survey for the two (2) ponds within the construction area shall be performed by the Contractor to verify sediment has not increased. The Contractor is responsible for ensuring that no additional sediment is deposited into the ponds as a result of this project's construction activities and that the Contractor shall be responsible for removal of additional sediment.

r. **Signing and Marking and Signalization Requirements**
General

Prepare signing, signalization and marking plans in accordance with the Manual of Uniform Traffic Control Devices (MUTCD) and any applicable AASHTO or Department standards and guidelines in effect at time of advertising.

Prepare plan sheets to show all permanent roadway signs and pavement markings as they appear upon completion of the project. Place emphasis on designing clear directional signage and coordinating sign placement with roadway features, structures, sight distances and driver awareness. All signs are to be replaced unless they meet the current reflectivity and design policy requirements.

A Traffic Engineering (TE) study shall be required where a new traffic signal is being proposed. Traffic signal permits shall be required for all locations.

Signalization plans are not included in the plans package. Provide signalization plans for approval. All signals installed shall be coordinated electronically and shall function together (not independently). All work shall comply with the Department's Specification Sections 647, 925, 935, 937, 938, 939 and 940 for traffic signal equipment, IVDS intersection video detection, Communications and Navigator Advanced Transportation Management System Integration. The contractor shall be responsible for all fees and permits necessary for establishing power to the traffic signal installations. The contractor shall be responsible for all charges associated with monthly utility service to the device until the device has satisfactorily completed a test period of uninterrupted operation, of at least 30 days. Prior to activating new signal equipment, the contractor shall contact the District Seven Traffic Signal shop at least 10 working days prior to activation to allow for preliminary inspection of the installation and development of signal timing. The Contractor shall be responsible for providing variable message signs to be placed in advance of each signal installation with text advising motorists of traffic signal activation prior to placing any new traffic signal into flashing operation.

Once placed into operation, the Contractor shall be responsible for responding to all reports of traffic signal "trouble" or malfunction until each traffic signal has successfully completed a 30 day test period. During the test period, the contractor shall be responsible for replacing all defective traffic signal equipment, until the traffic signal has completed the test period. If the signal is part of an operating traffic signal system whereby the signal operates in coordination with adjacent traffic signal installations, those traffic signals considered part of an operating traffic signal system, shall successfully complete a 30 day test period as part of a system test prior to District Seven Signal staff assuming responsibility for maintenance and operations of the new signals.

Driveway at Station 118+91.45 shall be signed to allow Service Vehicle Only at the entrance and exit to driveway.

s. **Utilities:**

(1) General

By Georgia Statutes, utilities whether public or privately owned, aerial or underground, are permitted by the Department and local governments to be accommodated within the public right of way. To this end, the Contractor needs to make every effort to design/build a project that shall accommodate (and minimize impacts to) all existing utilities and new utilities to be constructed concurrently with the project.

The selection of typical section features, horizontal alignment, and location of storm sewer lines are design elements that can sometimes be varied without violating safety standards, and accepted design principles. Design/construction techniques that minimize or avoid utility conflicts may involve increased upfront costs; however, those costs are offset by savings during construction, in addition to the total cost savings for the project owner (the Department or local government) and the respective utility owners.

Additional guidance for accommodating utilities within the right of way are given in the AASHTO publications: A Guide for Accommodating Utilities within Highway Right of Way, A Policy on Geometric Design of Highways and Streets; the TRB publication: Policies for Accommodation of Utilities on Highway Rights-of-Way; and in GDOT's Utility Accommodation Policy and Standards, current edition.

The Utility Plans are used as the primary tool to identify and resolve utility related conflicts/issues prior to beginning the construction of a project. Also, when these plans are properly prepared as indicated in this manual; they shall support the vital coordination required between the Contractor and the Utility Owner during construction.

Existing utility information shown on the Utility Plans for this project have been obtained from an Overhead / Subsurface Utility Engineering (SUE) Investigation (please refer to Section 2.C. for more information on SUE). This existing utility information has been provided by the Department for the Contractor's use in the design and construction of this project. However, the Contractor shall be responsible for supplementing this utility information for utilities that have been installed after the Overhead / Subsurface Utility Engineering (SUE) Investigation was performed. Known utilities and contacts are shown in the plans package. This information shall be verified by the Contractor.

Utility plan sheets are comprised of completed roadway plan sheets but shall contain more detailed information featuring existing and proposed utility facilities. Specific requirements for Utility Plans are detailed below.

(2) Required Information

(a) Preliminary Utility Plans

Preliminary Utility Plan sheets are typically comprised of preliminary roadway plan sheets with the inclusion of all existing utility facility locations (overhead & underground) found within a project's limits. Determining the location of the existing utilities was accomplished through an Overhead/Subsurface Utility Engineering Investigation. The "degree of effort" exerted on the part of the Department and the Utility Owner varies with the type and location of the utility. The Department has classified these "degrees of effort" into different Quality Levels of information. Please refer to Section 2.C. for definitions of these Quality Levels.

Preliminary Utility Plans shall be produced and used by the Contractor in the utility coordination/relocation design activities outlined here and under Section 999.1.A.4. The following minimum information shall be shown on the Preliminary Utility Plans:

1. Construction centerline with project stations and begin/end project limits.
2. Curb and gutter or edge of pavement (proposed and existing)
3. Road and street names

4. Existing and Required Right of Way limits, property lines, environmentally sensitive area limits, and property owners.
5. All proposed and existing easements (including existing utility easements)
6. Proposed and existing drainage structures/features (excluding drainage text)
7. Proposed construction limits (C/F lines)
7. Topographical planimetrics (i.e. existing buildings / structures, existing tree/vegetation limits)
8. All proposed bridges, walls, other structures and landscape hardscapes.
9. All proposed and existing strain poles (signal, sign, lighting)
10. Utilities Legend
11. Miscellaneous General Notes
12. Existing overhead and underground utilities found within the project's limits. Including size and material if known.
13. Sanitary sewer manhole top, and invert elevations. Sanitary Sewer pipe flow directions
14. Railroad mainline and spur tracks with their respective property/easement limits
15. Project Survey control point locations
16. SUE specific General Notes
17. Utility Pole Data Table
18. SUE investigation Limit of study
19. SUE Quality Level A information

(b) Final Utility Plans

Final Utility Plans consist of all the elements provided for in the Preliminary Utility Plans, but also show all proposed utility adjustments required to accommodate the project.

The proposed utility information shall either be provided to the Contractor by each of the respective Utility Owners, or included in the Design Scope for this project. Refer to Section 999.1.A.4 to determine how proposed utility relocation design information is to be provided. In either case, the Contractor shall compile and incorporate this information into the project's Final Utility Plans.

The proposed utility work for this project shall either be performed by the Utility Owner or their designated contractor, or included as part of the project's construction contract. Refer to Section 999.1.A.4 to determine who is responsible for the proposed utility relocation work for this project.

In either case, the Final Utility Plans shall clearly show all existing, proposed, temporary, and relocated utilities on the plans and clearly indicate the disposition of all existing utilities: for example, "To be removed", "To be Adjusted", "To be Abandoned", "To Remain", "To be Relocated", etc. The plans shall also clearly define utility work as to which is to be done by the Contractor and which is to be done by others. Utilities to be relocated (or removed, or installed) prior to construction shall be labeled on the plans as "To be relocated (or removed or installed) by others prior to project construction".

When proposed utility work is included as part of the project's contract, it is necessary for a Summary of Quantities to be included within the Final Utility Plans. The Summary of Quantities shown in the Final Utility plans shall be prepared in accordance with current Department procedures.

Where extensive or complex utility work is proposed to be performed, separate Utility Relocation Plan Sheets for that specific utility may be required to ensure plan legibility/constructability. The Contractor shall determine whether separate Utility Relocation Plans are needed. However, after review of the plans, the Engineer may require these additional sheets be included in the project plan package.

In addition to the information required for the Preliminary Utility Plans, the Final Utility Plans shall include the following:

1. All proposed and temporary utility facilities with annotation describing nature of work.
2. Miscellaneous General Notes required for coordination of utility facilities with roadway construction.
3. Proposed water and sanitary sewer plan/profiles.
4. Summary of Quantities for contract items (if applicable).
5. Any proposed utility easements.
6. Any miscellaneous proposed utility details.

(c) Overhead/Subsurface Utility Engineering (Sue) Investigations (Provided by the Department)

Employ an established engineering technology that can provide precise horizontal and vertical locations of underground and overhead utilities to produce an accurate picture of the underground and overhead utility infrastructure. The existing utility information provided in these investigations includes a description of what "degree of confidence" there is in its accuracy. The Department has classified these "degrees of confidence" into different Quality Levels of information:

Quality Level "D" Information - Information obtained solely from a review of utility records. The comprehensiveness and accuracy of such information is highly limited. Even when existing information for a utility in a particular area is accurate, there are often other underground systems that are not shown on any records. Quality Level "D" may be appropriately used early in the development of a project to determine the presence of utilities.

Quality Level "C" Information - Information obtained to augment Quality Level "D" information. This involves topographic surveying of visible, above-ground utility features (e.g., poles, hydrants, valve boxes, circuit breakers, etc.) and entering the topographic data into the CADD system. Since aerial utility lines are not surveyed, information provided for these facilities is considered Quality Level "C" also. Quality Level "C" may be appropriately used early in the development of a project and shall provide better data than Quality Level "D" information alone. Designers shall be very cautious when working on projects using information for underground utilities that is based only on Quality Levels "D" and "C" locates.

Quality Level "B" Information - Information obtained through the use of designating technologies (e.g., geophysical prospecting technologies). This is an application using scanning technologies, most of which have very specific capabilities. Applying a variety of techniques is essential to the process of preparing a comprehensive horizontal map of utilities and other underground structures on the site. Designating technologies are capable of providing good horizontal information.

Quality Level "A" (Test Hole) Information (not provided by the Department) - Provides the highest level of accuracy of utility locations in three dimensions. This level may apply manual, mechanical or nondestructive (e.g., vacuum excavation) methods to physically expose utilities for measurement and data recording. Quality Levels "B", "C", and "D" locates are incorporated in Quality Level "A" locates.

The Contractor shall identify all utility conflict points where verified existing utility information is necessary to avoid the respective utility conflict. The Contractor shall obtain Quality Level "A" locates at these project/utility conflict points, and shall coordinate with the Utility Owners and make every effort to avoid existing utility facilities and thereby reduce utility relocations.

This Quality Level "A" information shall be performed to GDOT standards by a prequalified firm in Subsurface Utility Engineering (SUE). Refer to the following website for a list of current prequalified firms:

<http://www.dot.state.ga.us/dot/preconstruction/consultantdesign/byclass/I508.htm>

(3) Sheet Layout

The Contractor needs to ensure that any information and graphic data that is not necessary to depict the disposition of utilities found within the project's limits is removed by turning off the appropriate CADD levels(s) on which the data is stored. This will help ensure that information pertinent to utility facilities can be clearly seen in the Utility Plan sheets. Examples of extraneous information would be items such as horizontal curve data, superelevation data, roadway dimensions, misc. text, etc. All background information such as pavement limits, existing structures, etc. shall be screened back. Also, the Contractor shall ensure all text, line work, details, and symbols are clear and legible when plans are reduced to 1/2 size.

In order to maintain plan clarity all applicable general notes, tables, Summary of Quantities, and the Utility Legend shall be placed separately from the Utility Plan sheets. This Utility Plan "Cover Sheet" shall be provided for both preliminary and final Utility Plans. A recommended example utility sheet schedule is provided below:

- Utility Sheet 1 (Cover Sheet) – Utility General Notes, Utility Legend, Miscellaneous Details
- Utility Sheet 2 (required as needed) – Additional Miscellaneous Details, Summary of Quantities, Pole Data Table
- Utility Plan Sheets – Utilities shown in plan view with respect to project.
- Utility Profile and Cross Sections Sheets - Proposed Utility facility profiles and cross sections (as required)
- Miscellaneous Utilities Sheets – Miscellaneous proposed utility details (as required).

The above sheet schedule shall also be generally followed for all separate utility relocation plans (i.e. water & sewer plans) included in the project plans.

(4) Miscellaneous Notes and Other Information

State on the Utility Plans whose responsibility it is for utility adjustment. If the Contractor is to adjust utilities, those items are to be summarized and the appropriate pay items are to be included on the detailed estimate.

For bridge plans required, the Contractor is to make sure the plans have made accommodations for utility crossings and attachments, if applicable. Any new utility crossings requests shall include the size, weight, and type of utility. In addition, the method of attachment to the bridge shall be fully detailed. Such requests shall be reviewed by the Contractor to ensure adequacy and constructability and final approval shall be obtained by the Contractor from the Department. The Contractor shall follow the approval process within this specification.

The Contractor is responsible to ensure that all proposed and existing utilities are coordinated with the respective project's Construction Staging and Erosion Control Plans.

Upon completion of the Utility Relocation Plans, the Contractor needs to ensure that any additional environmental impacts due to utilities are addressed in the project's environmental document/permit.

C. Bridges

1. General

DESIGN SPECIFICATIONS AND GUIDELINES: Design bridges in accordance with the 2002 AASHTO Standard Specifications for Highway Bridges, 17th Edition. Use GDOT Bridge Design Manual and Memos for information regarding bridge design practice located at the internet address:

<http://www.dot.state.ga.us/dot/preconstruction/bridgedesign/index.shtml>

Use "Basic Drawings where possible. Basic drawings and cells can be downloaded at the following internet address:

<http://www.dot.state.ga.us/dot/preconstruction/adds/bridge/index.shtml>

Use MicroStation/J to prepare plans in accordance with the Office of Bridge and Structural Design's MicroStation Customization. These files include a folder structure that is required to be on C:\Drive along with the "Bentley" folder. Access the Bridge MicroStation Customization files at the internet address:

<http://www.dot.state.ga.us/dot/preconstruction/adds/microstation/customization.shtml>

BRIDGE FOUNDATION INVESTIGATION:

The Department will supply bridge and wall foundation investigations for information only. If the Contractor proposes a new location for these structures from those shown in the Costing Plans, and the Department determines that additional investigations are required as a result of the change, then the investigation and reporting shall be prepared in accordance with the following:

A. General:

Perform field and laboratory testing and analysis, and prepare a report with foundation recommendations for the bridges and walls. Work is to be performed by qualified and experienced firms that are pre-qualified with the Georgia DOT in Area Class 6.02.

Perform work in accordance with AASHTO Standards and in general conformance with the Department's Geotechnical Engineering Bureau Foundation Drilling and Sampling Guidelines. Comply with all applicable Federal and State requirements.

B. Field Investigation:

Drill a minimum of one boring at each bent line and at each wall. Drill additional borings as necessary. Perform the following, as applicable:

- Notify property owners prior to accessing their properties.
- Obtain locations and clearance for all utilities within the area of the borings.
- Provide traffic control and lane closures in accordance with the Georgia DOT Specifications.
- Clearing and preparation of the boring site.
- Obtaining and transporting water to the site.
- Foundation drilling and sampling of soil and rock.
- Obtaining accurate survey elevations.
- Site cleanup, erosion control, and restoration.

Fill portions of all drill holes with drill cuttings after completion of drilling that are not subject to excavation for construction. Top off all drill holes through pavements with cold mix asphalt (unless subject to excavation) to the same depth as the existing pavement. Remove all drill cuttings, muddy water, slurry, and other debris deposited on pavements, paved shoulders, and other travel ways immediately when the areas shall be subject to traffic after the completion of drilling. Calculate elevations to an accuracy of one tenth (0.1) of a foot.

Do not provide copies of boring logs, plans, or field test reports to property owners or other parties without the permission of the State Geotechnical Engineer.

C. Laboratory Testing:

Perform laboratory testing on samples obtained from the field in accordance with applicable methods of AASHTO, ASTM, or GDT test procedures. Use a laboratory that possesses current AASHTO certification.

Furnish laboratory results as part of the Final Report.

D. Final Analysis and Report:

Perform a geotechnical analysis for this project and prepare geotechnical recommendations in the form of a final report to the Department's State Geotechnical Engineer for review, prior to foundation construction. Base the final report on the information collected from the field investigation, the plans, specifications, results of laboratory tests, and the analysis of all other available information.

Stamp and sign the final reports by a Professional Engineer registered in the State of Georgia. Provide copies of the final report to the State Geotechnical Engineer.

Prepare the reports in general conformance to the Department's Geotechnical Engineering Bureau Report Preparation Guidelines, Georgia DOT Specifications, and in conformance with good engineering practice. Incorporate the following recommendations and additional recommendations as applicable

- Foundation types and allowable loads.
- Footing elevations.
- Pile minimum and estimated tip elevations.
- Drilled caisson tip elevations.
- Small diameter micropile tip elevations.
- Foundation installations in rock.
- Embankment construction, settlement, and slope angles.
- Treatment of groundwater conditions.
- Treatment of poor soil conditions.
- Construction effects on adjacent structures and remedies for any potential problems.

In the Final Report, include (as applicable) copies of boring logs, field notes, laboratory and field test results or summaries, photographs, special provisions, details and drawings, and other related information. Correct final reports with errors and omissions, as determined by the State Geotechnical Engineer. Resubmit the corrected report at no additional cost to the Department.

Acceptance of the work by the Department will not relieve the Contractor of the responsibility for subsequent correction of errors or for the costs associated with work caused by negligent errors or omissions from work performed by the Contractor.

2. Plan Submittals:

- a. Preliminary Plans: Preliminary Layout (if required, see below) and Preliminary Wall Plans
- b. Construction Plans: Submit complete bridge plans and complete wall plans
- c. Shop Drawings.
- d. Submit one (1) copy of the design calculations for each scheduled submittal.
- e. Do not proceed with the final design of bridge plans until the preliminary plans have been approved by the Department and FHWA.

3. Preliminary Bridge and Wall Plans

A. Preliminary Bridge Plans

The existing bridge carrying Hammond Drive over SR 400 shall be replaced. The following information is to be used in the development of the final plans:

- a. The approved Preliminary Layout for the Hammond Drive Bridge over SR 400 is included in the contract documents.
- b. The Contractor shall check the Preliminary Layout supplied by the Department in the costing plans. This check shall verify all dimensions and clearances based on field measurements. Notify the Department of any discrepancies that may be present in the Preliminary Layout. The Contractor can accept the Preliminary Layout as provided in the costing plans by notifying the Department in writing. Upon the Contractor's

written acceptance of the Preliminary Layout, the Department will authorize the Contractor to proceed with final design of the bridge.

c. Should the Contractor choose to change the Preliminary Layout provided in the costing plans and provide an alternate design, the Contractor shall prepare a Preliminary Layout for the Department's review and approval in accordance with the following guidelines:

- (1.) The Contractor shall verify all dimensions and elevations in the field prior to preparing plans, ordering materials or building forms.
- (2.) Design the bridge replacement using prestressed concrete beams only. Steel beams will not be allowed.
- (3.) Do not increase stresses on existing bridge elements during staging.
- (4.) Design the substructure end bents and intermediate bents with concrete columns, caps, or walls with footings. Tops of footings shall be a minimum of two feet below future grade of SR 400 and associated CD routes.
- (5.) Provide a minimum vertical clearance of 17'-0" between the bottom of the Hammond Drive bridge superstructure and all current and future lanes on SR 400 and associated collector distributor and ramps. Contractor shall field survey the existing clearance over all travel lanes and submit the survey results to the Bridge Office along with the Preliminary Layout.

(6.) Provide a typical section which indicates the following information:

- The Center to center spacing of girders provided in the costing plans may be adjusted to optimize the beam design. The maximum center to center spacing of the girders is limited to 9'-0".
- Overhang or distance from outside edge of slab to center of exterior girder: This distance (overhang) shall meet AASHTO requirements, but shall not exceed 4'-6" or one half of the adjacent beam spacing, whichever is less.
- Cross slope of the deck.
- Deck thickness between girders and deck thickness at the centerline of girder measured from the top surface of deck to top of the flange.
- Provide a slab with a minimum thickness determined by the Georgia DOT computer program, BRSLAB07, Service Load Design of Concrete Bridge Slabs proportioned to provide 2.75 inches of concrete cover over the top mat of reinforcing and 1 inch cover to the bottom mat of reinforcement (minimum deck thickness is 7 inches). Use the slab thickness determined for the portion of the bridge supporting the highway loading at all locations.
- Barrier location, height and width.
- Gutter to gutter and out-to-out dimensions.
- Location of the profile grade.

(7.) In addition to the requirements above, provide the following:

- A plan view of the proposed structure indicating beginning and end bridge stations, construction centerline, profile grade line, bent skew angles, joint locations, station and skew of roadways crossing under the structure, width of roadways beneath the structure, gutter to gutter width of the bridge, out to out width of the bridge, distance from gutter to outside edge of deck, taper control stations, location of point of minimum vertical clearance, and location and magnitude of the horizontal clearances from

edge of travel way beneath the structure to the face of intermediate bents.

- Stations and elevations along the centerline of construction at the intersection of the centerline of construction and the back face paving rest and centerline of bents. Provide profile grade elevations corresponding to the above stations.
- An elevation view of the proposed structure indicating the span length, location of fixed and expansion joints, profile of roadways beneath structures, vertical clearance from bottom of structure to roadway beneath, proposed bent locations, and existing ground profile.
- All horizontal and vertical curve data for the bridge and the roadway beneath the bridge.
- The location and elevation of the nearest bench mark. The nearest benchmark shall be within 300 feet of the bridge.
- A brief description of the proposed structure indicating span lengths, and type of end bents.
- Any drawing and/or narrative description of the construction scheme necessary to indicate how the bridge is to be built, including traffic handling sketches and temporary barrier locations.

B. Preliminary Wall Plans

Retaining wall envelopes have been provided in the costing plans. Prepare Preliminary Wall Plans in accordance with the following guidelines:

- a. The wall types are as follows:
 - Wall SRIA – Tie-back
 - Wall SCIB – MSE (Mechanically Stabilized Earth) or Tie-back alternate
 - Wall NCIB – MSE (Mechanically Stabilized Earth) or Tie-back alternate
 - Wall HMDI – Type P, cast-in-place concrete
- b. Alternate wall types are permissible as approved by the Department. Soil-nail type walls and modular block type walls will not be allowed.
- c. An elevation view or wall envelope of the proposed wall drawn to a scale of 1:10 and indicating the following data:
 - Beginning and end wall stations.
 - Elevations on top of wall parapet, coping, or traffic barrier at the beginning and end of wall, at profile break points, and at least every 50 feet along the wall.
 - Bottom of wall (top of footing) elevation necessary to maintain minimum berm requirements.
 - Original ground profile.
 - Proposed ground profile.
 - Stations and offsets to ends of walls and locations where wall changes direction
 - Stations and elevations along top and bottom of wall
- d. Roadway cross-sections in the vicinity of the wall that will indicate the existing and final slope behind the wall.
- e. Typical sections for MSE walls shall include:
 - Limit of special backfill (1'-0" beyond end of reinforcement)
 - Reinforcement
 - Facing
 - Coping, parapet or barrier
 - Back-slope and fore-slope
 - Leveling Pad
 - Bridge abutment
 - Additional select backfill behind bridge abutment
 - Concrete ditches
- f. Typical sections for Tie-back wall shall include:
 - Soldier pile
 - Lagging
 - Concrete facing (12" minimum) and concrete leveling pad
 - Anchors, schematic only
 - Concrete ditch along top of wall
 - Rustication Groove detail
- g. Project Plan and Profile sheets which indicate the following:
 - Limits of right-of-way.
 - Superelevation data.
 - Horizontal and vertical alignment data.
 - Horizontal offsets to face of retaining wall.
 - Location and type of overhead signs which may be near retaining walls.
 - Location of roadway lighting which may be near or attached to the retaining wall.
 - Location and size of any drainage structures which will affect the retaining walls.

- e. Any construction sequence requirements that will affect the construction of the walls and which will have to be accounted for in the preparation of retaining wall plans.

4. Final Bridge and Wall Design

A. Additional Bridge Design Criteria as follows:

- a. The Contractor's design professionals, in designing the bridge in this project, shall utilize the Department Bridge Geometric and Design Software to the maximum extent possible. Upon prior written approval by the Department, the Contractor's design professionals may be authorized to utilize its computer capabilities. The contractor's design professionals are required to verify results to obtain final design accuracy.
- b. Design the bridge replacement for seismic performance category "A".
- c. Use ASTM A 615 Grade 60 reinforcement.
- d. Use Class AA Concrete with a minimum 28-day concrete strength of 3,500 psi for superstructure and substructure concrete.
- e. Include 30 pounds per square foot in the design loads to allow for future paving.
- f. If metal deck forms are used, include 16 pounds per square foot in the non-composite design loads.
- g. Design and detail 1'-0" wide edge beams where the deck is to be discontinuous. Detail edge beams as provided in the Bridge Design cell library for the appropriate prestressed beam.
- h. Concrete decks shall be made continuous at intermediate bents; no expansion joints at the intermediate bents will be allowed. Continuity shall not be dependent on dead or live load. See Bridge Design memos for details.
- i. Place slab transverse and longitudinal reinforcing steel 2 inches from the edge of the slab and place the top mat of edge beam bars below the top mat of the deck steel. Do not use truss shaped bars in the edge beam. Extend stirrups from the edge beam into the slab.
- j. Use protective platforms in accordance with Section 510 of the GDOT Specifications. Maintain a minimum of 16'-6" vertical clearance over SR 400.
- k. Use the following in the design and construction of the bridge foundations:
 - Foundation Type:
 - Bents 1 & 4: Steel H-pile, Pile Bent
 - Bents 2 & 3: Steel H-pile, Pile Footing
 - Maximum Design Loads:
 - 10 BP 42 = 55 Tons
 - 12 BP 53 = 70 Tons
 - 14 BP 73 = 96 Tons

- Plan Driving Objective – At each bent, drive all piles to the design driving resistance after achieving the minimum pile tip elevation as follows:

<u>Bent Number</u>	<u>Minimum Pile Tip Elevation</u>
1L	955
1C	955
1R	960
2L	953
2C	953
2R	943
3L	945
3C	940
3R	930
4L	945
4C	935
4R	925

- Use a minimum of one pile per beam location at end bents. Use a minimum of one pile at each wingwall and pile size equivalent to piles supporting beams within the end bent.
- Reinforce pile tips at Bent 4 Right in accordance with Sections 520 and 855 of the GDOT Specifications.
- Protect piles driven within the limits of MSE walls from negative skin friction, see Section 551 of the Georgia DOT Specifications. Drive these piles before wall leveling pads are constructed.

I. For prestressed beams, meet the following criteria:

- Design prestressed concrete beams with conventional strength concrete up to a maximum 28 day compressive strength of 9,000 psi.
- Design prestressed concrete beams with high performance concrete (HPC) for a maximum 56 day compressive strength over 9,000 psi up to 10,000 psi. The maximum design compressive strengths shall not exceed 10,000 psi.
- Design prestressed beams as simple spans.
- In calculation of prestressed girder section properties, do not utilize transformed area of bonded reinforcement.
- Use neoprene bearing pads at each end of the prestressed beams. Design the pads to account for transverse and longitudinal expansion and contraction.
- Use anchorage beds set for horizontal and vertical strand patterns of two inches center to center. Detail all straight and draped strands utilizing two inch spacings.
- Provide the minimum amount of reinforcing steel at beam ends as required by AASHTO specifications, Article 9.22.
- Detail beam lengths to 1/16 inch increments.
- Provide prestressed beam sheets with all the applicable details as shown on the “basic drawings.”
- Require the use of 10 inch wide concrete.

B. Additional Wall Design Criteria as follows:

- a. MSE Walls are to be constructed in accordance with Section 627 of the GDOT Specifications.
- b. Tie back walls are to be constructed in accordance with Section 617 of the GDOT Specifications.
- c. Use the following in the design and construction of the walls:
 - Wall SRIA
 - Soil Unit Weight, $\gamma = 120$ pcf

- Angle of effective internal friction, $\phi = 28$ degrees
- Cohesion, $C = 0$ psf
- Coefficient of sliding friction, $\mu = 0.40$
- Wall SCIB
 - Soil Unit Weight, $\gamma = 115$ pcf
 - Angle of effective internal friction, $\phi = 30$ degrees
 - Cohesion, $C = 0$ psf
 - Coefficient of sliding friction, $\mu = 0.40$
 - Maximum allowable bearing pressure = 2500 psf (for MSE wall)
 - For an MSE wall, if the calculated bearing pressure exceeds the maximum allowable design pressure, build wall to a height equivalent to the maximum allowable design pressure and wait a period of 30 days. After this waiting period, the construct wall to final height.
- Wall NCIB
 - Soil Unit Weight, $\gamma = 120$ pcf
 - Angle of effective internal friction, $\phi = 28$ degrees
 - Cohesion, $C = 0$ psf
 - Coefficient of sliding friction, $\mu = 0.40$
 - Maximum allowable bearing pressure = 1500 psf (for MSE wall)
 - For an MSE Wall, if the calculated bearing pressure exceeds the maximum allowable design pressure, build wall to a height equivalent to the maximum allowable design pressure and wait a period of 30 days. After this waiting period, the construct wall to final height.
- Wall HDMI
 - Soil Unit Weight, $\gamma = 120$ pcf
 - Angle of effective internal friction, $\phi = 28$ degrees
 - Cohesion, $C = 0$ psf
 - Coefficient of sliding friction, $\mu = 0.40$
 - Maximum allowable bearing pressure = 2500

5. Bridge and Wall Construction Plans:

The Contractor shall meet with the Department and discuss how the plans will be prepared prior to beginning plan preparation on the project.

- a. Prepare construction plans with all dimensions, notes and details necessary to construct the structure. As a minimum, include the following sheets:
 - Plan and Elevation sheets that include:
 - (1.) Plan view of the bridge,
 - (2.) Elevation view of the bridge,
 - (3.) Beginning and ending stations,
 - (4.) North arrow,
 - (5.) Location of fixed and expansion bearings,
 - (6.) Location of the minimum vertical clearance above SR 400,
 - (7.) Existing Bridge Serial No., Existing Bridge ID No., Project No. Project PI No., and construction ID No. supplied by the Department.
 - General Notes sheets that include:
 - (1.) Notes for the following; Specifications, Reinforcing Steel, Chamfer, Existing Bridge Plans, Welding, Salvage Material, and others as necessary,
 - (2.) Bridge Design Data,
 - (3.) A summary of Bridge Consists Of,
 - (4.) A summary of Traffic Data,

- (5.) A summary of Quantities (for information only)
- (6.) A list of Existing Utilities (if applicable),
- (7.) A list of Utilities

- Deck Plan sheets,
- Deck Cross-Section sheets,
- Bearing assembly sheets,
- Beam sheets,
- Miscellaneous sheets,
- Framing Plan and Substructure Layout sheets,
- End Bent/Abutment sheets,
- Intermediate Bent sheets,
- As Built Foundation sheets, and
- Bar Reinforcing Detail sheets.

Additional sheets may be necessary to show the details required for construction. Provide additional sheets at no additional cost when deemed necessary by the Department.

b. Provide the following details:

- On deck section sheets, provide one full-width section across the structure which indicates, at least, all the horizontal dimensions necessary to construct the bridge. Provide sufficient deck cross-sections to indicate the staging, location of the existing structure and location of any temporary barriers on the structure.
- Show as many sections as are necessary to detail the placement of reinforcing in the deck and barrier. Also, draw deck sections indicating edge beams, back walls, diaphragms, and end walls. Cut sections radially across the structure.
- Detail deck plan sheets with all longitudinal and transverse dimensions necessary to construct the bridge, including edge beam width, expansion joint widths, back wall or end wall locations, location of construction and expansion joints, and any other items that are necessary to construct the structure.
- All views, sections and details, except those in GDOT's standard bridge cell library, are to be drawn to scale. Draw deck cross-sections and intermediate bent sheets "Looking Ahead". If the end bents or abutments are drawn separately, draw bent/abutment one "Looking Back", and draw the other end bent/abutment "Looking Ahead".
- All details on the Plans shall be clear and legible. The Department will have the final say as to how a Project is to be drawn and will have the right to require additional drawings at no increase in Contract cost. Fully check the plans for completeness of content and accuracy before submittal to the Department for review.

c. Maintain and protect all utilities supported and in the area of the bridge during construction. Consider the installation of utilities in staging the construction of the bridge.

d. Groove the bridge deck in accordance with Section 500 of the Georgia Specifications.

SHOP DRAWINGS:

Provide shop drawings in accordance with Georgia DOT Specifications. The Contractor's Design Engineer shall review and stamp approved all shop drawings as the Engineer of Record. After being stamped by the Contractor's Design Engineer, the Department will

review the shop drawings for conformance with the plans and specifications. Allow the Department a **30 day review period** upon receipt of the shop drawings for each submittal.

BRIDGE REMOVAL

The existing aluminum handrail is to be salvaged for use by the Georgia DOT. Remove and stockpile the material. No other materials removed from the existing structure are to be salvaged for use by the Georgia DOT. The Contractor is responsible for the removal and disposal of all material removed from the existing bridge that are not salvaged. There is no suitable location within project limits for the disposal of the existing bridge. The Contractor shall be responsible for locating and obtaining a suitable location for the disposal of the existing bridge. The Contractor shall be responsible for obtaining all necessary permits associated with the disposal.

The existing bridge has been repainted but may contain lead paint.

999.4 CONSTRUCTION

The Contractor shall construct the project as per the project scope and as per the approved final plans in accordance with the Specifications. Three (3) full size and three (3) half size approved final plans shall be submitted to the Department's Area Office at least 2 (two) weeks prior to the Contractor performing ground-breaking activities.

Construction includes, but is not limited to, the following:

- All clearing and grubbing and grading required in accordance with Sections 201, 202, 205, 206, 208 and 209;
- All necessary grading and drainage (All proposed pipes shall be concrete) to construct the subgrades, including the removal and replacement of unsuitable material, shoulders and incidental work to include furnishing borrow pits, waste disposal areas and hauling borrow and waste materials as required. The removal and replacement of unsuitable material is the responsibility of the Contractor;
- All necessary culvert extensions including the removal and replacements of headwalls, aprons and rip rap. Existing culverts shall be analyzed for structural sufficiency for new fills. Existing portions of culvert shall be removed and replaced with appropriate excavation and shoring as needed.
- All necessary base construction, milling, leveling, asphalt paving and concrete paving to construct the pavement structure;
- Removal of all curbs, drainage structures, pavements, bases and sub-bases, or other obstructions within the rights of way as necessary to construct the roadway section;
- All signing, Interstate signage including sign structures, signalization, pavement marking, raised pavement markers, guardrail;
- All equipment and materials stored on the project shall be stored outside the clear zone.
- No construction shall occur outside of the existing right of way/proposed limits as determined in the Costing Plans.

- Errors and omissions are the responsibility of the Design/Build Contractor to correct and at the expense of the Contractor;
- All salvageable material from this project will become the property of the Georgia Department of Transportation.
- Preparation of As-Built Construction Plans

999.5 MEASUREMENT AND PAYMENT

The Work required under the Specification shall not be measured separately for payment unless otherwise specified in the detailed estimate. Payment for the items listed below, complete and accepted, shall be made at the Lump Sum price bid. Payment shall be full compensation for furnishing all materials, labor, tools, equipment, superintendence, mailing charges, removal and replacement of unsuitable material and other incidentals. It shall also be made for performing all work specified, including but not limited to, designing, detailing, producing construction plans (preliminary and final, electronic and hard copy), meeting with the Department, processing the NOI and complete construction. For all asphalt concrete, when materials or construction are not within the tolerances specified in Section 400, deductions shall be made in accordance with the applicable requirements of Sub-Sections 106.03 and 400.07.

Partial payments of the Lump Sum price shall be made on monthly statements based on an approved schedule of payment. The Contractor shall develop a schedule for payment for each of the following items:

- DESIGN COMPLETE
- CONSTRUCTION COMPLETE

The schedule for payment shall include a rational basis for partial payments of the Lump Sum bid based on the completed portion of the item and definitive activities. The schedule for payment shall be submitted to the Engineer and no payments shall be made until the plan is approved. No construction shall begin prior to said schedule being approved by the Engineer.

At the end of each calendar month, the Contractor shall provide the Department with a certification showing the percent complete for each Pay Item. The Contractor shall include a breakdown and supporting documentation, to include the Design Consultant’s monthly invoice, in sufficient detail to substantiate the percent complete certified.

Payment shall be made under:

Item 999, DESIGN COMPLETE	per Lump Sum
Item 999, CONSTRUCTION COMPLETE	per Lump Sum

November 25, 2008

AMENDMENT TO ADVERTISED CONTRACT

CONTRACT I.D. NUMBER: B13095-08-000-0
GEORGIA PROJECT NUMBER: CSNHS-0008-00(415)01
PCN: 0008415010000
COUNTY: FULTON
AMENDMENT NUMBER: 1
LETTING DATE: DECEMBER 12, 2008
LETTING NUMBER: 001

THE FOLLOWING CHANGES ARE HEREBY MADE TO THIS CONTRACT. THE BIDDER IS RESPONSIBLE FOR MAKING ANY NECESSARY CHANGES IN INK IN THE PROPOSAL. BIDDER SHALL ACKNOWLEDGE THIS AMENDMENT BY CHECKING THE APPROPRIATE SPACE ON THE PROPOSAL SIGNATURE PAGE.

1. Costing Plans, Sheet 93A; **Add** the following note to the sheet:

"The wall shown in the Plan Elevation section between Bents 2 and 3 will be constructed in the future CD lane project (P.I. No 721850).

Top of footing for Bent 3 shall be placed at an approximate elevation of 970.30' so that it will not interfere with future roadway to be constructed under PI 721850- Fulton County. The Contractor shall be responsible for grading this area to drain."
2. **Delete** Proposal Pages 387 and 388 from the proposal; **and Substitute** the attached revised/added pages 387 and 388 in the proposal.
3. Proposal Page 402, Special Provision Section 999-Design-Build, Subsection 999.1A.3.; **Revise** the "ninth bullet" to read as follows:

"The one (1) sound barrier constructed as part of this project will be temporary, and its final location will be established as part of P.I.721850. Sound barrier type B or type C shall be used."
4. Proposal Page 403, Special Provision Section 999-Design-Build, Subsection 999.1A.3.; **Add** the following to the subsection:

"The existing woven wire fence along the old right of way line shall be replaced in the areas where it is impacted. The new fence shall be placed along the Right of Way lines where possible or along construction limits in those areas where Right of Way is outside of construction

AMENDMENT TO ADVERTISED CONTRACT (continued):

limits. The new fence shall tie to the existing Right of Way fence and shall be installed after grading activities are complete.

Right of Way markers shall be installed along Hammond Drive. Right of Way markers will be installed along SR 400 under project 721850- which is to be constructed at a future date."

5. Proposal Page 410, Special Provision Section 999-Design-Build, Subsection 999.1A.6.; **Add** the following sentence:

"Mitigation will not be included as a part of the Contractor's responsibility."

6. Proposal Page 415, Special Provision Section 999-Design-Build, Subsection 999.2 Plans; **Add** the following items:

15. Original plans M-9255(1) Hammond Drive over SR 400 - For Information Only
16. Preliminary profile, typical section, and plan sheet excerpts from PI 721850 - Fulton County at Hammond Drive Bridge - For Information Only
17. SR 400 at Hammond Drive Sound Barrier Information - For Information Only
18. As-Builts provided by Fulton County Department of Public Works - For Information Only

7. Proposal Page 431, Special Provision Section 999-Design-Build, Subsection 999.3.B.1.r.; **Make** the following changes:

A. Revise the first paragraph to read as follows:

"Prepare signing, signalization and marking plans in accordance with the Manual of Uniform Traffic Control Devices (MUTCD), any applicable AASHTO guidelines in effect at time of advertising, and GDOT's Signing and Marking Guidelines (Last Rev. 11/08)."

B. Delete the last sentence stating: "Driveway at Station 118+91.45 shall be signed to allow Service Vehicle Only at the entrance and exit to driveway."

C. Add the following to the subsection:

"Strain poles used for construction of traffic signals and overhead wire spans shall be Prestressed Concrete or steel."

"If any overhead sign panel on a specific Type I structure is replaced due to the project then all other sign panels on the same structure should be replaced with new sign panels that meet GDOT's Signing and Marking Guidelines (Last Rev. 11/08)."

AMENDMENT TO ADVERTISED CONTRACT (continued):

8. Proposal Page 443, Special Provision Section 999-Design-Build, Subsection 999.1C; **Revise** the "last bullet" to read as follows:

"Use 10 inch wide concrete diaphragms or galvanized structural steel diaphragms. For exterior beams, provide recess detail similar to that shown in the Georgia DOT basic drawings for PSC Beams, at the approval of the Engineer."

9. Proposal Page 446, Special Provision Section 999-Design-Build, Subsection 999.4A; **Revise** the first paragraph to read as follows:

"The Contractor shall construct the project as per the project scope and as per the approved final plans in accordance with the Specifications. No construction is to begin on any phase of the work prior to receiving approval of the plans for that phase from the Engineer. Three (3) full size and three (3) half size sets of approved plans shall be delivered to the Department's Area Office at least 1 (one) weeks prior to the Contractor performing initial ground-breaking activities. The Contractor shall deliver all subsequent approved plans at least 24 (twenty four) hours before construction activities."

DAVID E. HOGE
STATE TRANSPORTATION OFFICE ENGINEER

**DEPARTMENT OF TRANSPORTATION
STATE OF GEORGIA
SPECIAL PROVISION**

**PROJECT: CSNHS-0008-00(415), FULTON COUNTY,
PI # 0008415**

Section 107 – Legal Regulations and Responsibility to the Public

Add the following to Subsection 107.23:

G. Protection of Federally Protected Environmentally Sensitive Species

The following conditions are intended as a minimum to protect these species and their habitat during any activities that are in close proximity to the known location(s) of this species. The specific activity that these conditions apply to is the demolition of the existing Hammond Drive bridge over SR 400 in Fulton County.

1. The Contractor shall advise all project personnel employed to work on this project about the potential presence and appearance of federally protected Eastern phoebes (*Sayornis phoebe*), cliff swallows (*Petrochelidon pyrrhonota*) or barn swallows (*Hirundo rustica*) and that there are civil and criminal penalties for harming, harassing, or killing these species, which are protected under the Migratory Bird Treaty Act of 1918. Pictures and habitat information will be provided to the Contractor at the preconstruction conference.
2. The above referenced activity shall take place outside of the breeding and nesting season of Eastern phoebes and swallows, which typically begins April 1st and extends through August 31st, unless exclusionary barriers are installed as described below and successfully prevent the nesting of these migratory bird species on the bridge(s). Exclusionary devices in the form of netting made of plastic, canvas or other materials that are proposed by the contractor may be installed on the bridge(s) prior to February 1st, but after August 31st. The following requirements must be met in order for exclusionary netting to be considered appropriate:
 - a. Prior to the installation of any exclusionary devices, the project ecologist must be notified by phone at (404) 699-4301 or (404) 699-4400, or by email at jcollazo@dot.ga.gov of the decision to install exclusionary devices under the existing bridge and the date of installation.
 - b. Project personnel shall be alert to the possibility of migratory bird nesting activity taking place earlier than is typically known to occur, or previously unnoticed nesting migratory birds that have become trapped under the bridge(s) subsequent to exclusionary device installation. If, at any time immediately prior to, during or after exclusionary device installation, such occurrences are observed, all construction/demolition activity on the bridge(s) must immediately cease and be postponed until after August 31st, the exclusionary devices shall be immediately removed, and the project ecologist shall be immediately notified as described above. Only if nests are not found or existing nests are unoccupied, is the installation of exclusionary devices is permissible.
 - c. On bridges that are to be jacked, painted or demolished, exclusionary netting should be placed along the full length of the bridge to prevent the birds from accessing any existing nesting habitat. The exclusionary netting shall be installed prior to February 1st and, unless it fails to prevent the nesting of migratory birds, shall remain in place until August 31st or until the bridgework is complete, whichever occurs first.
 - d. The exclusionary netting must prevent birds from accessing nesting habitat along the full length of the bridge until the commencement of jacking/painting/demolition work (i.e., sawing or removal of bridge items for operational access). If the exclusionary netting fails to prevent nesting (i.e., birds are able to bypass barriers and build nests within the exclusionary netting), the netting shall be immediately removed and all construction activities associated with the bridge must be postponed until after August 31st when the breeding season is complete.
3. During construction activities, exclusionary netting shall be inspected for holes or other defects that impair the netting's ability to exclude phoebes or swallows from inhabiting the bridge. In the event any incident occurs that causes harm to Eastern phoebes, cliff swallows or barn swallows, or that could be detrimental to the continued existence of Eastern

REVISED / ADDED 387

Section 107 – Legal Regulations and Responsibility to the Public

phoebes, cliff swallows or barn swallows along the project corridor, the Contractor shall report the incident immediately to the Project Engineer who in turn will notify:

- a. U.S. Fish and Wildlife Service, Athens Field Office at (706) 613-9493;
- b. Federal Highway Administration (FHWA), Georgia Division at (404) 562-3630; and
- c. Glenn Bowman, GA Dept. of Transportation, Office of Environment/Location at (404) 699-4401 or (404) 326-5871.

In the event of possible harm to Eastern phoebes, cliff swallows or barn swallows, the above agencies and the Project Engineer shall be notified immediately and all activity shall cease pending consultation by the Department with the U. S. Fish and Wildlife Service and the lead Federal Agency.

4. Following project completion, a report summarizing any incidents with Eastern phoebes, cliff swallows or barn swallows shall be submitted by the Contractor to the:
 - a. the Project Engineer;
 - b. U.S. Fish and Wildlife Service, 105 West Park Drive, Suite D, Athens, GA 30606;
 - c. Federal Highway Administration, 61 Forsyth Street, S.W., Suite 17T100, Atlanta, GA 30303;
 - d. Nongame/Endangered Wildlife Program, Georgia Department of Natural Resources, 115 Rum Creek Dr, Forsyth, GA 31029 and;
 - e. Georgia Department of Transportation, Office of Environment/Location, 3993 Aviation Circle, Atlanta, GA 30336.
5. All costs pertaining to any requirement contained herein shall be included in the overall bid submitted unless such requirement is designated as a separate Pay Item in the Proposal.

December 9, 2008

AMENDMENT TO ADVERTISED CONTRACT

CONTRACT I.D. NUMBER: B13095-08-000-0
GEORGIA PROJECT NUMBER: CSNHS-0008-00(415)01
PCN: 0008415010000
COUNTY: FULTON
AMENDMENT NUMBER: 2
LETTING DATE: DECEMBER 12, 2008
LETTING NUMBER: 001

THE FOLLOWING CHANGES ARE HEREBY MADE TO THIS CONTRACT. THE BIDDER IS RESPONSIBLE FOR MAKING ANY NECESSARY CHANGES IN INK IN THE PROPOSAL. BIDDER SHALL ACKNOWLEDGE THIS AMENDMENT BY CHECKING THE APPROPRIATE SPACE ON THE PROPOSAL SIGNATURE PAGE.

1. Costing Plans; **Make** the following changes:
 - A. Plan Sheets 3 (5-01) and 5 (5-03); **Change** the specified mix **From** "12.5 MM SMA (165 LB/SY)" **To** "12.5 MM SUPERPAVE, GROUP 2 with POLYMERS (165 LB/SY)".
 - B. Plan Sheet 73; **Add** the following note:

"The Contractor shall remove the 2.5 inch conduit labeled as "for toll booth sensor" from existing bridge. This line is not in service and will not be replaced as part of this project."
2. **Delete** Special Provision Section 109-Measurement and Payment, with a revised date of October 8, 2008, from the proposal, **and Substitute** the attached Special Provision Section 109-Measurement and Payment, with a revised date of December 4, 2008, in the proposal.
3. **Delete** Proposal Page 447 from the proposal, **and Substitute** the attached revised/added pages 447 and 448 in the proposal.
4. Proposal Pages 256 and 257, Special Provision Section 500-Concrete Structures; **Delete** "Subsection 500.5.01 Adjustments" from the pages.

DAVID E. HOGE
STATE TRANSPORTATION OFFICE ENGINEER

Date: March 13, 2007
Revised: May 3, 2007
Revised: April 8, 2008
Revised December 4, 2008

**DEPARTMENT OF TRANSPORTATION
STATE OF GEORGIA**

SPECIAL PROVISION

**Project Number: CSNHS-0008-00(415)
P.I. Number: 0008415
Fulton County**

Section 109—Measurement and Payment

Delete Subsection 109.07B.4 and Substitute the following:

No materials allowance will be made for a material when the requested allowance for such material is less than \$50,000.00.

Office of Contract Administration

- Errors and omissions are the responsibility of the Design/Build Contractor to correct and at the expense of the Contractor;
- All salvageable material from this project will become the property of the Georgia Department of Transportation.
- Preparation of As-Built Construction Plans

999.5 MEASUREMENT AND PAYMENT

The Work required under the Specification shall not be measured separately for payment unless otherwise specified in the detailed estimate. Payment for the items listed below, complete and accepted, shall be made at the Lump Sum price bid. Payment shall be full compensation for furnishing all materials, labor, tools, equipment, superintendence, mailing charges, removal and replacement of unsuitable material and other incidentals. It shall also be made for performing all work specified, including but not limited to, designing, detailing, producing construction plans (preliminary and final, electronic and hard copy), meeting with the Department, processing the NOI and complete construction. For all asphaltic concrete, when materials or construction are not within the tolerances specified in Sections 400 and 402, deductions shall be made in accordance with the applicable requirements of Sections 106, 400 and 402. The deduction will be determined by the following formula:

Deduction (per ton) = (1 – Pay Factor) X Assumed Unit Price/Ton
 (See Chart Below)

<u>Material</u>	<u>Assumed Unit Price/Ton</u>
Asphalt Concrete 12.5 mm Superpave	\$63.00
Asphalt Concrete 12.5 mm Superpave with Polymer	\$74.00
Asphalt Concrete 19 mm Superpave	\$60.00
Asphalt Concrete 25 mm Superpave	\$62.00
Asphalt Concrete 12.5 mm SMA	\$101.00
Asphalt Concrete 12.5 mm leveling	\$67.00

Asphalt cement price adjustments will be computed on a monthly basis in accordance with Sub-Sections 400.5, 402.5, 413.5, and 424.5 based on documented materials incorporated into the Project.

Partial payments of the Lump Sum price shall be made on monthly statements based on an approved schedule of payment. The Contractor shall develop a schedule for payment for each of the following items:

- DESIGN COMPLETE
- CONSTRUCTION COMPLETE

The schedule for payment shall include a rational basis for partial payments of the Lump Sum bid based on the completed portion of the item and definitive activities. The schedule for payment shall be submitted to the Engineer and no payments shall be made until the plan is approved. No construction shall begin prior to said schedule being approved by the Engineer.

At the end of each calendar month, the Contractor shall provide the Department with a certification showing the percent complete for each Pay Item. When Gross Earnings of \$500,000 or more for work completed within the first 15 days can be certified, the Contractor may provide the Department

REVISED/ADDED 447

a certification showing the percent complete for each Pay Item on a semi-monthly basis. The Contractor shall include a breakdown and supporting documentation, to include but not be limited to the Design Consultant's monthly invoice and all materials invoices and other documentation for materials certification, in sufficient detail to substantiate the percent complete certified.

Payment shall be made under:

Item 999, DESIGN COMPLETE	per Lump Sum
Item 999, CONSTRUCTION COMPLETE	per Lump Sum

REVISED / ADDED 448

December 10, 2008

AMENDMENT TO ADVERTISED CONTRACT

CONTRACT I.D. NUMBER: B13095-08-000-0

GEORGIA PROJECT NUMBER: CSNHS-0008-00(415)01

PCN: 0008415010000

COUNTY: FULTON

AMENDMENT NUMBER: 3

LETTING DATE: DECEMBER 12, 2008

LETTING NUMBER: 001

THE FOLLOWING CHANGES ARE HEREBY MADE TO THIS CONTRACT. THE BIDDER IS RESPONSIBLE FOR MAKING ANY NECESSARY CHANGES IN INK IN THE PROPOSAL. BIDDER SHALL ACKNOWLEDGE THIS AMENDMENT BY CHECKING THE APPROPRIATE SPACE ON THE PROPOSAL SIGNATURE PAGE.

REVISE TO READ:

LINE NO.		DESCRIPTION	QUANTITY
0005	150-9011	TRAFFIC CONTROL - WORKZONE LAW ENFORCEMENT (CONTRACTOR BIDS)	2500 HR

1. Proposal Page 446, Special Provision Section 999-Design-Build, Subsection 999.4A; **Add** the following to the first paragraph:

"All plans submitted to the Area Office for use on construction shall include all applicable Standards and Details required in the Work."

DAVID E. HOGE
STATE TRANSPORTATION OFFICE ENGINEER