

Traffic Signal Design Guidelines

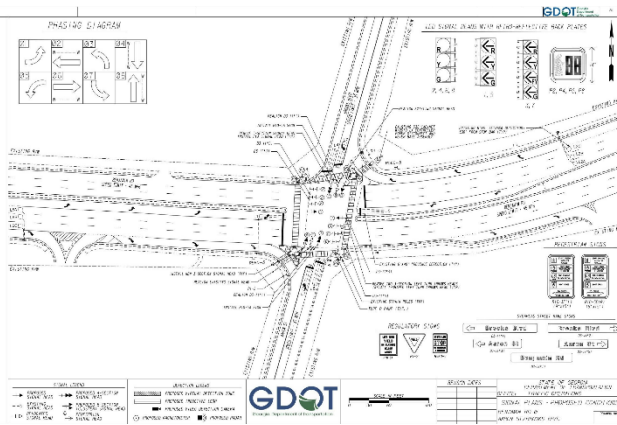
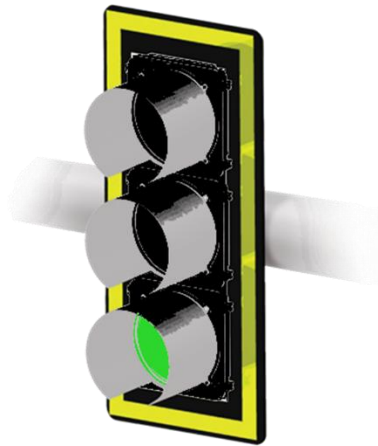

4/21/2023
Revision 6.0
Atlanta, GA 30308

This document was developed as part of the continuing effort to provide guidance within the Georgia Department of Transportation in fulfilling its mission to provide a safe, efficient, and sustainable transportation system through dedicated teamwork and responsible leadership supporting economic development, environmental sensitivity and improved quality of life. This document is not intended to establish policy within the Department, but to provide guidance in adhering to the policies of the Department.

Your comments, suggestions, and ideas for improvements are welcomed.

Please send comments to:

State Design Policy Engineer
Georgia Department of Transportation
One Georgia Center
600 West Peachtree Street, N.W., 26th Floor
Atlanta, Georgia 30308

DISCLAIMER

The Georgia Department of Transportation maintains this printable document and is solely responsible for ensuring that it is equivalent to the approved Department guidelines.

Revision History

Revision Number	Revision Date	Revision Summary
1.0	11/2000	Initial release of document
1.1	5/2003	Draft of first major update
1.2	11/2003	Final of first major update
2.0	2/2011	Major update
3.0	12/2013	Major update
4.0	8/2015	Major update
4.1	10/2015	Major update
4.2	2/2016	<p>Minor Update:</p> <p>Chapter 4 - Traffic signal strain poles should be designed to provide adequate clearance for the addition of future left-turn phases.</p> <p>Chapters 10 & 12 - Traffic signal face and blank-out sign treatments for railroad pre-emption.</p> <p>Chapter 12 - The assignment of side street phases for split phase intersections.</p> <p>Chapter 12 - Consideration should be given to avoid creating a left-turn trap when entering the pre-emption sequence.</p> <p>Chapter 13; Appendix B - Traffic signal face treatment for shared through/left travel lanes.</p> <p>Chapter 13 - Minimum requirements and engineering judgment for the installation of supplemental signal heads.</p> <p>Chapter 13 - Configuration of bi-modal FYA signal heads, bottom section should display both the green and flashing yellow indications.</p> <p>Chapter 15 - Options for the installation of a typical vehicle detection.</p> <p>Appendix A - Design example for radar vehicle detection.</p>
5.0	5/2017	<p>Reformatted manual to standard template. Revised and updated content:</p> <p>Acronyms – Added acronyms.</p> <p>Chapter 1 – Updated list of standards and specifications.</p> <p>Chapter 2 – Added language on GDOT list of materials.</p> <p>Chapter 3 – Added reference to GDOT Utility Accommodation Policy and Standards Manual regarding joint use of utility facilities.</p>

		<p>Chapter 4 – Added language on the use of mast arm and span wire configurations. Added language on modified box span.</p> <p>Chapter 5 – Updated Figure 5-1. Added language regarding the placement and purpose of detectable warning surfaces.</p> <p>Chapter 6 – Added language on the use of non-GDOT standard cabinets.</p> <p>Chapter 7 – Removed language on fiber optic installation.</p> <p>Chapter 11 – Added language on the use of the pavement marking “ONLY.”</p> <p>Chapter 12 – Changed reference of overlap from OLA to OL1 to reflect the new signal software MaxTime. Added language on installing a 3 section permissive FYA for left-turn movements opposing a four-section FYA signal head. Added language on U-turn movements opposing a FYA at T-intersections. Removed reference to hardwired overlap.</p> <p>Chapter 13 – Added language on installing FYA for left-turn movements opposing a four-section FYA signal head. Added language on factors to consider for the use of supplemental heads. Removed reference to shifted signal heads.</p> <p>Chapter 15 – Added language on the use of departure detection.</p>
<p>6.0</p>	<p>4/21/2023</p>	<p>Major Update</p> <p>Incorporation of best practices from other state DOTs.</p> <p>Chapter 1 has been converted to Introduction and purpose statement with guidance for coordinating with GDOT</p> <p>Chapter 2 has added discussion on the permitting process and excerpts from other chapters involving plan presentation have been consolidated here for better organization.</p> <p>Chapters 3 and 4 have been combined into Chapter 3.</p> <p>Chapters 5 and 14, both relating to pedestrians (design and equipment, respectively), have been combined into the new Chapter 4. Chapter has been edited where necessary to be consistent with new GDOT Streetscape Guide.</p> <p>Chapter 5 discusses traffic signal cabinets and contains a graphical table with guidance on the application of each type of cabinet. Additional clarification will be added to the tables presenting</p>

		<p>the cabinet input files. Input file information is difficult to convey in text or bullet form.</p> <p>Chapter 6 now covers communications and updated to provide guidance on current practices.</p> <p>Chapter 7 Wiring Standards now includes a graphical table to illustrate conductor considerations.</p> <p>Chapter 8 Conduit and Pull Boxes contains a new discussion on conduit sizing and fill from the NEC. Tables from the Ohio DOT have been copied in as place holders to be updated and customized for GDOT during the review process.</p> <p>Chapter 9 Traffic Signal Signs received minor edits to text for clarity.</p> <p>Chapter 10. Vehicle Detection better outlines the design considerations and application of each type of detection.</p> <p>Chapter 11 is a new compilation of all document references with hyperlinks to source documents.</p> <p>Appendix A Example Signal face alignment graphics have been updated and now presented in color.</p> <p>Example signal plans in Appendix B has been updated with some of the most recent designs approved by GDOT.</p> <p>Other graphical examples of plan sheets will have updated plan sheets submitted by GDOT to address new GDOT logo and other plan presentation updates.</p> <p>Previous Appendix C, items on the materials list, was removed from the TSDG for ease of updating the materials list as a web-based document in the future.</p> <p>Previous Appendix D has been removed - duplicated information in the GDOT cell library and Appendix A.</p>

Intentionally Left Blank

List of Effective Chapters

Document	Revision Number	Revision Date
List of Effective Chapters	6.0	4/21/23
Table of Contents	6.0	4/21/23
Acronyms and Definitions	6.0	4/21/23
Chapter 1. Introduction	6.0	4/21/23
Chapter 2. General Information	6.0	4/21/23
Chapter 3. Traffic Signal Poles	6.0	4/21/23
Chapter 4. Pedestrian Infrastructure	6.0	4/21/23
Chapter 5. Cabinet Assemblies	6.0	4/21/23
Chapter 6. Traffic Signal Communication	6.0	4/21/23
Chapter 7. Wiring Standards	6.0	4/21/23
Chapter 8. Conduit and Pull Boxes	6.0	4/21/23
Chapter 9. Traffic Signal Related Signs	6.0	4/21/23
Chapter 10. Vehicle Detection	6.0	4/21/23
Chapter 11. References	6.0	4/21/23
Appendix A. Traffic Signal Plan Examples	6.0	4/21/23
Appendix B. Vehicular Signal Head Placement Examples	6.0	4/21/23

Intentionally Left Blank

Table of Contents

Revision History	i
List of Effective Chapters	v
Table of Contents.....	vii
Acronyms and Definitions	xi
Acronyms.....	xi
Chapter 1.Introduction - Contents.....	1-i
1.1 Introduction.....	1-1
1.2 Coordination Requirements.....	1-1
Chapter 2. General Information - Contents.....	2-i
2.1 Permitting Process	2-1
2.2 Cost Participation	2-1
2.3 Applicable Standards and Specifications	2-2
2.4 Signal Design Process	2-3
2.5 Traffic Signal Plan Presentation	2-5
2.5.1 Signal Upgrade Project	2-9
2.6 Traffic Signal Face Placement.....	2-9
2.6.1 Through Movements	2-9
2.6.2 Left-Turn Movements with Dedicated Left-Turn Lanes	2-9
2.6.3 Left-turn Movements with Shared-Through/Left Lane.....	2-10
2.6.4 Sight Distance	2-10
2.6.5 Supplemental Signal Faces.....	2-10
2.6.6 Vertical Clearance	2-11
2.6.7 Bicycle Signals	2-11
2.7 Traffic Signal Phasing Diagram	2-11
2.7.1 Left-Turn Phasing.....	2-13
2.7.2 Right-Turn Overlap.....	2-14
2.7.3 Split Phasing	2-14
2.8 Pre-emption	2-15
2.8.1 Railroad Pre-Emption	2-15
2.9 List of Materials and Pay Items	2-17
2.10 CAD Elements	2-17
Chapter 3. Traffic Signal Poles - Contents.....	3-i
3.1 Pole Placement	3-1
3.2 Pole Types.....	3-1
3.2.1 Mast Arm Poles	3-2

3.2.2	Strain Poles	3-3
3.2.3	Joint Use (Utility) Poles	3-3
3.2.4	Timber Poles	3-4
3.3	Span Wire Configuration	3-4
Chapter 4.	Pedestrian Infrastructure - Contents	4-i
4.1	Marked Crosswalks	4-1
4.2	Curb Ramps and Concrete Landing Pads.....	4-2
4.3	Pedestrian Signal Faces.....	4-3
4.4	Pedestrian Detection	4-3
4.5	Pedestrian Refuge Areas	4-4
4.6	Pedestrian Signs	4-5
4.7	Pedestrian Hybrid Beacons	4-7
4.8	Rectangular Rapid Flashing Beacon	4-8
4.9	Accessible Pedestrian Signals (APS).....	4-9
Chapter 5.	Cabinet Assemblies - Contents.....	5-i
5.1	Cabinet and Cabinet Bases.....	5-1
5.2	Input File and Cabinet Input Assignments.....	5-3
5.3	Uninterruptable Power Supply	5-3
5.4	Power Disconnect.....	5-3
Chapter 6.	Traffic Signal Communication - Contents.....	6-i
6.1	Cellular Modems.....	6-1
6.2	Fiber Optic Plant.....	6-1
6.3	CAV Applications.....	6-1
6.4	Quantities	6-2
Chapter 7.	Wiring Standards - Contents	7-i
7.1	Signal Conductor Cable.....	7-1
7.2	Non-Signal Conductor Cabling	7-2
7.2.1	Shielded Three-Pair Lead-in Cable	7-2
7.2.2	Communications Cabling	7-3
7.2.3	Grounding Conductors and Electrodes	7-3
Chapter 8.	Conduit and Pull Boxes - Contents	8-i
8.1	Conduit Calculations.....	8-1
8.2	Pull Boxes.....	8-3
8.3	Trenching and Boring	8-5
Chapter 9.	Traffic Signal Related Signs - Contents	9-i
9.1	Regulatory Signs	9-1
9.2	Guide Signs	9-2

- Chapter 10. Vehicle Detection - Contents..... 10-i
 - 10.1 Methods of Detection..... 10-1
 - 10.1.1 Inductive Loop Detectors..... 10-1
 - 10.1.2 Microwave/Radar Detection 10-3
 - 10.1.3 Wireless Magnetometer Detection 10-4
 - 10.1.4 Intersection Video Detection Systems (IVDS) 10-5
 - 10.2 Detector Size, Shape and Placement..... 10-6
- Chapter 11. References - Contents 11-i
- Appendix A. Traffic Signal Plan ExamplesA-1
- Appendix B. Vehicular Signal Head Placement ExamplesB-1

Intentionally Left Blank

Acronyms and Definitions

Acronyms

AASHTO	American Association of State Highway and Transportation Officials
ADA	Americans with Disabilities Act
APS	Accessible Pedestrian Signals
ATC	Advanced Transportation Controller
ATSPM	Automated Traffic Signal Performance Measures
CAD	Computer-Aided Drafting
CAV	Connected / Autonomous Vehicles
CCTV	Closed Circuit Television
DSRC	Dedicated Short Range Communications
EDG	Electronic Data Guidelines
FDU	Fiber Distribution Unit
FHWA	Federal Highway Administration
FPP	Fiber Patch Panel
FYA	Flashing Yellow Arrow
GDOT	Georgia Department of Transportation
GRS	Galvanized Rigid Steel
HDPE	High-Density Polyethylene
ICE	Intersection Control Evaluation
ITE	Institute of Transportation Engineers
ITS	Intelligent Transportation Systems
IVDS	Intersection Video Detection System
LED	Light Emitting Diode
MPH	Miles per Hour
MUTCD	Manual on Uniform Traffic Control Devices
NEC	National Electrical Code
NEMA	National Electrical Manufacturers Association
NESC	National Electrical Safety Code
OTO	Office of Traffic Operations
PDP	Plan Development Process
PHB	Pedestrian Hybrid Beacon

PPG	Plan Presentation Guide
PPLT	Protected/Permissive Left Turn
PROWAG	Proposed Right-of-Way Accessibility Guidelines
RRFB	Rectangular Rapid Flashing Beacon
RSU	Roadside Unit
RTOP	Regional Traffic Operations Program
TE	Traffic Engineering Study
UPS	Uninterruptable Power Supply
V2X	Vehicle to Everything

Chapter 1. Introduction - Contents

Chapter 1. Introduction - Contents 1-i

1.1 Introduction.....1-1

1.2 Coordination Requirements1-1

Chapter 1. Introduction

1.1 Introduction

The purpose of this guide is to document standards, procedures, specifications, and preferences to be used in the design of traffic signal installations for the Georgia Department of Transportation (GDOT).

This guide presumes some level of experience on the part of the designer. This guide presents GDOT's interpretations for the application of requirements found in external policy, design manuals, and federal regulations such as the [Manual on Uniform Traffic Control Devices](#) (MUTCD), American Association of State Highway and Transportation Officials (AASHTO) [Roadside Design Guide](#), and the [Americans with Disabilities Act](#) (ADA).

Sound traffic engineering judgment should be exercised in applying these guidelines.

This guide briefly outlines:

- Permitting process
- Coordination with and cost participation by local agencies
- Design references
- Current preferences regarding plan presentation
- Current design preferences
- Materials and equipment

Ramp meters are a type of traffic signal; however, ramp meter design is not covered in this guide. Refer to the current edition of the [GDOT ITS Design Guide](#) for more information on ramp meters.

1.2 Coordination Requirements

The designer shall coordinate with GDOT under the following scenarios regarding traffic signal devices on state routes:

- Requests for a new traffic control device by the following constituents:
 - Private citizen
 - Local agency
 - Developer
- Proposed physical modifications/upgrades to existing traffic control devices, such as:
 - Adding or removing traffic signal phases
 - Conducting partial or full reconstruction
 - Relocating pole to accommodate roadway/streetscape modifications
 - Replacing aged infrastructure
 - Adding emergency vehicle pre-emption, bus pre-emption, or CAV applications

- Adding communications
- Attaching street name signs.

Chapter 2. General Information - Contents

- Chapter 2. General Information - Contents2-i
- 2.1 Permitting Process2-1
- 2.2 Cost Participation2-1
- 2.3 Applicable Standards and Specifications2-2
- 2.4 Signal Design Process2-3
- 2.5 Traffic Signal Plan Presentation2-5
 - 2.5.1 Signal Upgrade Project2-9
- 2.6 Traffic Signal Face Placement.....2-9
 - 2.6.1 Through Movements2-9
 - 2.6.2 Left-Turn Movements with Dedicated Left-Turn Lanes2-9
 - 2.6.3 Left-turn Movements with Shared-Through/Left Lane2-10
 - 2.6.4 Sight Distance2-10
 - 2.6.5 Supplemental Signal Faces.....2-10
 - 2.6.6 Vertical Clearance2-11
 - 2.6.7 Bicycle Signals2-11
- 2.7 Traffic Signal Phasing Diagram2-11
 - 2.7.1 Left-Turn Phasing2-13
 - 2.7.2 Right-Turn Overlap.....2-14
 - 2.7.3 Split Phasing2-14
- 2.8 Pre-emption2-15
 - 2.8.1 Railroad Pre-Emption2-15
- 2.9 List of Materials and Pay Items2-17
- 2.10 CAD Elements2-17

Chapter 2. General Information

This chapter covers the basic steps and approval chain for requesting a new or modified traffic signal device.

2.1 Permitting Process

There are many types of traffic control devices, including signs, pavement markings, and traffic signals. The traffic signal policy for the Office of Traffic Operations (OTO) identifies certain traffic signal devices that require a permit to be installed on any state route. As a class of traffic control device, these signals are electrical devices which involve some type of support structure(s). These include the following:

- Traditional traffic signals, including temporary installations
- Advanced warning flashers
- School flashers
- Overhead beacon
- Pedestrian Hybrid Beacons (PHB)
- Rectangular Rapid Flashing Beacons (RRFB)

Currently, the only electrical traffic control devices that do not require a permit are:

- Interstate ramp meters
- Supplemental flashers on roadway signs

When modifying an existing traffic signal device, the designer should consult the District Traffic Operations Office to verify whether an approved permit exists. The signal permit revision, based on the final plan submission, should be submitted to the District Traffic Operations Office for approval and incorporation into the permit records.

To obtain a new traffic signal permit, the designer shall conduct and submit a Traffic Engineering (TE) study to the local GDOT District office that includes:

- Traffic signal warrant analyses
- ICE (for signals and overhead beacons)
- Preliminary signal design
- Any supporting documents such as local government concurrence

Refer to GDOT Traffic Signal Policy 6785-1 for additional information on the signal permitting process.

2.2 Cost Participation

GDOT provides a consistent baseline of equipment for every installation on PDP projects per current traffic signal specifications (see Section 2.3). Alternative equipment is allowed when coordinated and approved with the district office. Costs above the baseline cost associated with these items shall be

paid by others (i.e., local agencies or private developers requesting the equipment). Some examples of alternative equipment include, but are not limited to:

- Decorative poles
- Emergency vehicle or transit signal priority pre-emption systems
- Alternative detection systems for vehicles, pedestrians, or bicycles
- Alternative signal cabinets

Cost participation is also required for developments of regional impact that meet the appropriate traffic signal warrants.

2.3 Applicable Standards and Specifications

Documents listed below provide more detail concerning specific traffic engineering design elements. Unless otherwise indicated, the designer should consult the most current version of the documents referenced in this guide.

All work shall be constructed in accordance with the project plans and specifications, which shall reference the [GDOT Standard Specifications: Construction of Transportation Systems, latest edition](#). Specific sections associated with traffic signal work include the following:

- [Section 636 – Highway Signs](#)
- [Section 639 – Strain Poles for Overhead Signs and Signal Assemblies](#)
- [Section 647 – Traffic Control Signal Installation](#)
- [Section 682 – Electrical Wire, Cable, and Conduit](#)
- [Section 925 – Traffic Control Signal Equipment](#)
- [Section 926 – Wireless Communications Equipment](#)
- [Section 935 – Fiber Optic System](#)
- [Section 936 – Closed Circuit Television \(CCTV\)](#)
- [Section 937 – Detection Systems](#)
- [Section 939 – Communications and Electronic Equipment](#)

Other applicable manuals and guidelines for the design of traffic signals include:

- GDOT [Design Policy Manual](#)
- GDOT [Electronic Data Guidelines](#) (EDG)
- GDOT [ITS Design Manual](#)
- GDOT [Pedestrian and Streetscape Guide](#)
- GDOT [Plan Development Process](#) (PDP)
- GDOT [Plan Presentation Guide](#) (PPG)
- GDOT [Signing and Marking Design Guidelines](#)

- GDOT [Standard and Detail Sheets](#)
- GDOT [Traffic Signal Policy 6785-1](#)
- GDOT [Traffic Signal Policy 6785-2](#)
- GDOT [Policy and Procedure 4270-1](#)
- GDOT [ICE Policy](#)
- GDOT [Utility Accommodation Policy and Standards](#)
- AASHTO [A Policy on Geometric Design of Highways and Streets](#) (“Green Book”), latest edition adopted by GDOT. Design standards outlined in this publication shall govern most geometric considerations.
- AASHTO [Roadside Design Guide](#). This document defines the clear zone requirements.
- AASHTO [Standard Specifications for Structural Supports for Highway Signs, Luminaries, and Traffic Signals](#). This document provides criteria for structural design.
- Federal Highway Administration (FHWA) [Manual on Uniform Traffic Control Devices](#) (2009). This document shall govern the application of all signs, signals, and pavement markings not specifically covered by the above materials.
- FHWA [Railroad-Highway Grade Crossing Handbook](#)
- FHWA [Standard Highway Signs](#). Wherever possible, designated traffic signs shall be as specified in this document.
- FHWA [Traffic Detector Handbook, Volume I](#) (2006)
- FHWA [Traffic Detector Handbook, Volume II](#) (2006)
- FHWA [Work Zone Operations Best Practices Guidebook](#) (2013)
- Institute of Transportation Engineers (ITE) [Manual of Traffic Signal Design](#)
- *Transportation Electrical Equipment Specifications*, current edition and addenda. These specifications are referenced by GDOT’s Traffic Signal Equipment specifications.

2.4 Signal Design Process

The following is a general list of recommended tasks and information needed for designing traffic signals. This list is only provided as a guide and is not all-inclusive.

Recommended Field Information

- Obtain project background and design data.
- Investigate future local or GDOT projects at or nearby your site; these may affect your design.
- Prepare topographical survey, including the following:
 - Existing signal equipment, if any
 - Right-of-way and any existing easements

- Environmentally sensitive areas
- Above ground and subsurface utilities
- Conduct initial site visit, including the following:
 - Perform field check of survey data
 - Review geometric features of intersection approaches
 - Meet with GDOT Traffic Operations, Utilities, and/or local officials
 - Identify power source
 - Locate existing communications, if any

Design Considerations

- Identify signal operational requirements (verify with TE studies, where applicable)
- Left-turn phasing
- Pedestrian crossings
- Overlaps
- Pre-emption (by local agencies)
- Turn restrictions
- Locate signal poles
- Determine overhead structure support type (span wire/mast arm)
- Locate crosswalks, stop lines, and ADA ramp locations
- Locate signal faces (vehicles/pedestrian) and pushbuttons
- Determine method of detection and detector locations
- Select type and location of cabinet
- Locate pull boxes and conduits
- Identify sign requirements
- Utilize existing or design new communications

The designer should visit the site to verify that existing characteristics are documented and incorporated in the design. The following standard roadway features should be documented

- Turn bay lengths
- Approach grades
- Horizontal curvature
- Roadside slope
- Potential sight distance constraints (e.g., trees combined with horizontal curvature)
- Any existing traffic signal infrastructure

2.5 Traffic Signal Plan Presentation

For consistency in construction drawings, GDOT has developed the [PPG](#) and the [EDG](#). The [PPG](#) contains basic requirements for traffic signal plans. The [EDG](#) presents detailed information related to CAD standards and file structure.

In addition to the [PPG](#), OTO has the following preferences for information included in traffic signal plans:

- Current traffic signal notes
- Current signal and detection legend
- Existing traffic signal equipment (if any)
- Traffic signal list of materials with quantities and pay items, located on separate sheet immediately following the intersection design
- Cabinet input assignments, located on separate sheet immediately following the intersection design, are only required when the proposed design deviates from the standard 332 input wiring.
- Overhead street name (D-3) signs detailed with dimensions, located on separate sheet combined with above items, or a dedicated sheet in the 27 series to D-3 signs

Quick response and signal upgrade projects may deviate from the GDOT [EDG](#) and GDOT [PPG](#) standards. The designer should coordinate with the GDOT Project Manager to determine CAD requirements for these programs.

A stand-alone traffic signal project, with a Project Identification (PI) number, follows the GDOT [PDP](#) process. These are upgrade projects for one or more intersections that may include minor intersection reconstruction. These upgrades may address anything ranging from adding a left-turn phase or pedestrian facilities to full rebuilds of aged infrastructure.

For stand-alone traffic signal projects, the existing traffic signal information should be presented on a separate plan sheet immediately before the proposed traffic signal updates. Note: The existing plan sheet should include proposed pole locations along with existing utilities and roadway information. The minor construction activities not related to the traffic signal installation at the intersection including, but not limited to, ADA-compliant sidewalk facilities, islands, and/or restriping can be shown on the proposed traffic signal plan sheets. Refer to Section 2.5.1 for more information.

Normally, the traffic signal plan sheets should be oriented the same as the construction plan sheets. However, there may be occasions to rotate the traffic signal plan sheets differently than the construction plan sheets. For recordkeeping, OTO prefers to orientate the signal design plan sheet with the north arrow up or to the right of the page. **Figure 2-1** illustrates the preferred orientation of the north arrow. The north arrow should point within the hatched area shown.

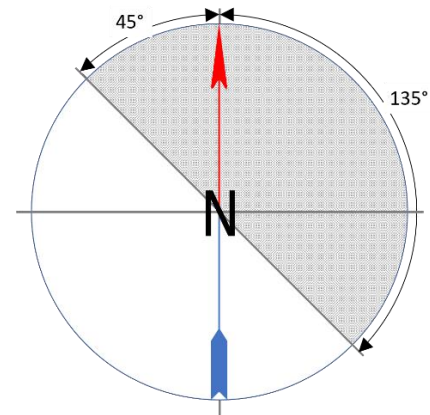

Figure 2-1: Preferred North Arrow Orientation

Traffic signal plans should be oriented with the main street displayed left to right across the page. Traffic signal plan sheets should be designed to be clear and legible on 11-inch by 17-inch plan sheets, showing as much existing and proposed roadway information as possible (i.e. edge of pavement, curb and gutter, sidewalk, concrete islands, pavement markings, existing and proposed traffic signal-related signage, right-of-way). The GDOT [PPG](#) specifies a scale for traffic signal plans to be one inch equals 30 feet; however, other scales may be considered depending on the size and scope of an intersection.

Each traffic signal plan sheet should include the following:

- North arrow
- Graphic scale bar
- Signal legend and detection legend
- Created/revision/approved date
- Street names and posted speed limits
- Overhead street name signs
- Existing/proposed regulatory signs
- Existing/proposed pavement markings
- Existing/proposed crosswalks and ramps
- Vehicular and pedestrian signal faces
- Existing/proposed vehicle detection
- Pole locations (station and offset)
- Phasing diagram
- Traffic signal cabinet
- Power source and disconnect location
- Existing and proposed right-of-way
- Dimension distances from stop bar to front of setback detectors or detector zones

The drawing number should start with “27-0001”, beginning with the Traffic Signal General Notes and Traffic Signal Legend sheets. The sheet number will increase by one for each new plan sheet added to the signal design section (27-0002, 27-0003, etc.). Company logos, scale, revision dates, office where the signal plan sheets were completed, location of intersection, and drawing number should be documented in the title block on the bottom of each signal plan sheet. Design information that falls beyond the typical extents should be shown using match lines or break lines. The preferred layout of a signal plan sheet is as follows:

- Phasing diagram - top left corner
- Traffic signal faces - top right corner
- Signs - lower right corner
- Construction notes – lower left corner

Figure 2-2 and Figure 2-3 show examples of the recommended traffic signal plan sheet layouts.

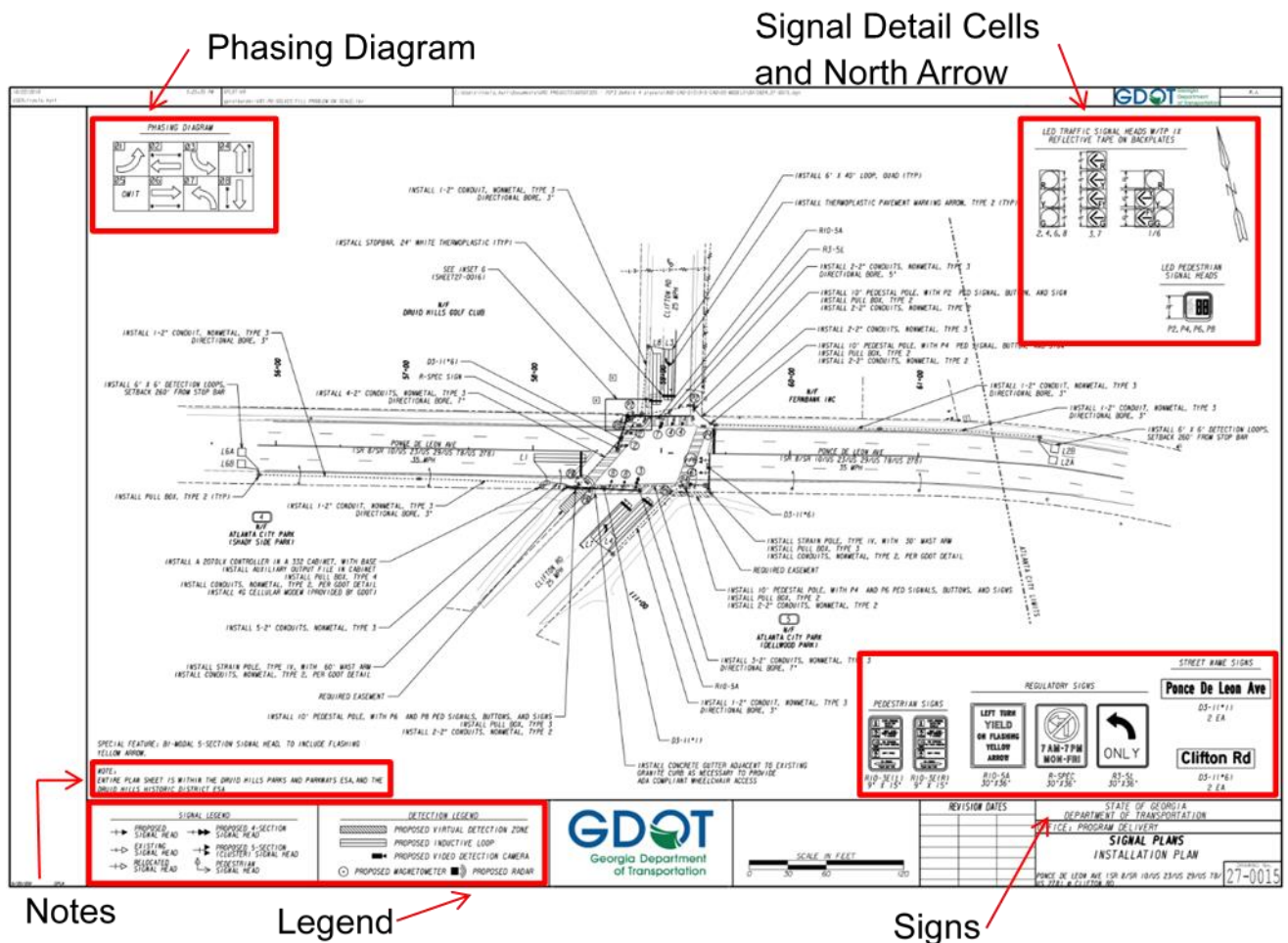
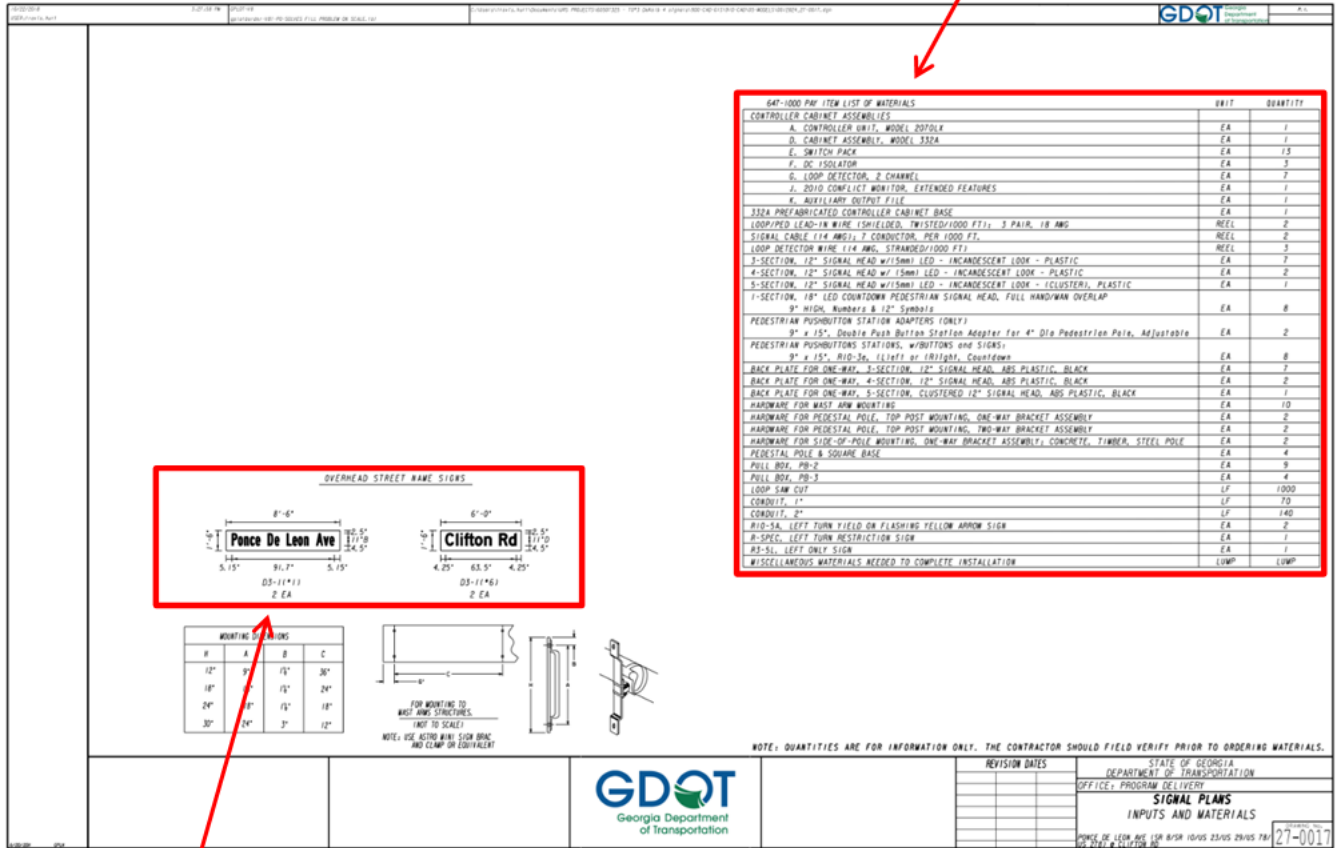

Figure 2-2: Preferred Plan Layout

List of Materials



Overhead Street Name Signs

Figure 2-3: Preferred Secondary Plan Sheet Layout

Existing signal infrastructure should be shown with dashed or gray scale, per the GDOT [EDG](#) requirements.

The existing and proposed information should fill as much of the sheet as possible. Inserts and details may to be used, if necessary, to reduce clutter and clarify construction requirements on the plan sheet.

The placement of these items is only a recommendation and should be moved to different locations on a signal plan sheet if needed to reduce clutter. GDOT’s Signal Legend and Detection Legend should be provided in the lower left corner of the title block to help identify commonly used cells and remove the need to show a callout for every signal component in the installation.

Overhead street name signs should be designated on a plan sheet as D3-1 and D3-1a, as shown in [Section 2D](#) of the MUTCD. The designation should also contain a sequentially increasing number to denote each street name sign such as D3-1 (#1), D3-2 (#2), etc.

2.5.1 Signal Upgrade Project

Signal upgrade projects should follow GDOT [EDG](#) requirements and include all sheets typically included in a series 27 plan set, as well as the following for each intersection:

- Existing conditions and proposed structures plan sheet (poles only)
- Proposed signal plan sheet

The existing conditions and proposed structures plan sheet should include existing infrastructure, existing utilities, existing right-of-way, and proposed structures (signal pole, utility lines, utility poles, right-of-way, etc.). All existing equipment should be shown in grayscale on the existing conditions and proposed structures plan sheet, excluding proposed structures and utilities. Utilities should not be shown on the proposed signal plan sheets.

2.6 Traffic Signal Face Placement

All traffic signal faces shall be designed and placed in accordance with the [MUTCD Part 4D](#). The following sections elaborate further on GDOT's interpretation of criteria and design preferences, among the options presented, in the MUTCD.

2.6.1 Through Movements

A minimum of two signal faces shall be placed on each intersection approach. At intersections involving more than two approach lanes, one signal face per through lane should be provided. Traffic signal faces for through movements should be placed such that they guide vehicles into the appropriate receiving lane. This does not necessarily place the traffic signal face over the center of the approach lane. The signal faces should be placed on the centerline of the receiving lane. There are cases where extreme curvature through an intersection will exceed the 20-degree cone of vision and minimum eight-foot spacing between signal faces required by the MUTCD. If signal faces cannot be placed within this longitudinal range, supplemental signal faces are required.

Appendix B: Vehicular Signal Face Placement Examples illustrates numerous common scenarios for signal face placement. The examples provide guidelines for signal display and turn indications for a variety of intersection approach configurations. The designer should keep in mind that these are examples and that engineering judgment should be used for each traffic signal design.

2.6.2 Left-Turn Movements with Dedicated Left-Turn Lanes

The type, number, and positioning of left-turn signal faces is dictated by the type of left-turn treatment. The types of left-turn treatment include:

- Permissive-only left-turn phases should be controlled with a three-section FYA signal face (red arrow, yellow arrow, FYA) centered in front of the turn lane.
- Protected/permissive phases should be controlled by a four-section FYA signal face centered in front of the turn lane. A four-section signal face is the preferred option. Protected/permissive operation of multilane left turns is not allowed. Note: A single left-turn lane with a permissive-only phase opposing a four-section FYA signal face shall have a three-section permissive-only FYA signal face centered in front of the lane.

- Protected-only phase is controlled with a three-section left-turn arrows signal face centered in front of the left-turn lane. Multiple lane left turns shall operate as protected only and have one signal face per lane centered in front of each turn lane. Note: a single lane, protected-only left turn shall display one 4-section T-shaped head centered in front of each turn lane.

2.6.3 Left-turn Movements with Shared-Through/Left Lane

A permissive-only left turn that does not have a dedicated lane opposing a four-section FYA signal face can be controlled with a 5-section (dog-house) FYA signal face centered in front of the lane with the bottom left section containing the flashing yellow left arrow display.

A protected/permissive left-turn phase that does not have a dedicated left-turn lane can be controlled with a 5-section (dog-house) bimodal FYA signal face centered in front of the lane with the bottom left section containing both the solid left green arrow and the flashing yellow left arrow. Note: This is only recommended where a dedicated left-turn lane cannot be provided.

When designing traffic signal plans with lanes designated for both through and left-turn traffic, contact the Statewide Signal Operations Engineer or the Metro Atlanta Signal Operations Engineer for information on the recommended signal face arrangement. See *Appendix B: Vehicular Signal Face Placement Examples for design guidelines*.

2.6.4 Sight Distance

The two primary signal faces should be continuously visible to traffic approaching the traffic signal. The sight distance measured to the signal face is dependent upon the 85th percentile approach speed to the signal faces, as referenced in MUTCD Section 4D.12, Table 4D-2.

2.6.5 Supplemental Signal Faces

All supplemental heads should use a three-section signal face. Typically, supplemental signal faces are supported by the signal span wire either on the lead from the signal pole to the bullring or on the bullring itself. Supplemental signal faces may be mounted on pedestals only when necessary and installed such that the lowest part of the traffic signal face is a minimum of 12 feet and maximum of 19 feet above the sidewalk or pavement grade of center of the roadway. Pedestal mounted signal faces should only be used for supplemental purposes.

When considering the use of supplemental heads consider the following factors as specified in Section 4D of the MUTCD:

- Nearest signal face is located between 150 and 180 ft beyond the stop line
- Typical signal face arrangement does not allow the minimum sight distance visibility
- Approaches having a posted speed or 85th percentile speed of 45 mph or higher
- High percentage of truck traffic

Use engineering judgment to determine the need for supplemental heads. The number and arrangement of supplemental signal faces are subject to the approval of the State Traffic Engineer. Supplemental signal faces should be labeled with the phase number and an "S" (for example 4S or 2S) on the signal plan sheets. The supplemental traffic signal face label should be placed next to the signal face location cells and underneath the signal face detail cells.

2.6.6 Vertical Clearance

- Measurements for vertical clearance should be taken from the lowest part of the assembly, including brackets and backplates.
- For traffic signal faces located above the roadway, vertical clearance should be a preferred minimum of 17 ft (5.2 m) with a maximum height of 19 ft (5.8 m) above the roadway surface.
- For traffic signal faces located on a pole, vertical clearance should be a minimum of 12 ft (3.6 m) and a maximum of 19 ft (5.8 m) above the sidewalk or pavement grade of the center of the highway, whichever grade is higher.
- Signal faces on the same approach should have the same vertical clearance.

2.6.7 Bicycle Signals

The use of bicycle signals at a signalized intersection or mid-block crossing should be implemented consistently with the requirements set forth by the MUTCD and applicable interim approvals. The most current resource at time of publication is [Interim Approval for Optional Use of a Bicycle Signal Face \(IA-16\)](#) and related official interpretations.

Bicycle signal faces should be limited to designated bike routes with a separate bike lane facility, and the design should be coordinated with the local agency to achieve consistency throughout the corridor. The faces are only utilized in situations where bicycles moving on a green or yellow signal indication in a bicycle signal face are not in conflict with any simultaneous motor vehicle movement at the signalized location, including right (or left) turns on red. Consideration should be made by the engineer regarding their placement and operation with regards to vehicular, cyclist, and pedestrian comprehension and visibility.

2.7 Traffic Signal Phasing Diagram

GDOT's preferred signal phasing is for phase 2 to be assigned to the main street serving the westbound or southbound direction, as shown on Figure 2-4. The remaining phases are numbered in sequence around the intersection in a counterclockwise direction, illustrated on Figure 2-4. For plan presentation, the phase numbers shall be noted for each vehicular and pedestrian signal face. An example of the signal face phasing numbering is illustrated on Figure 2-5.

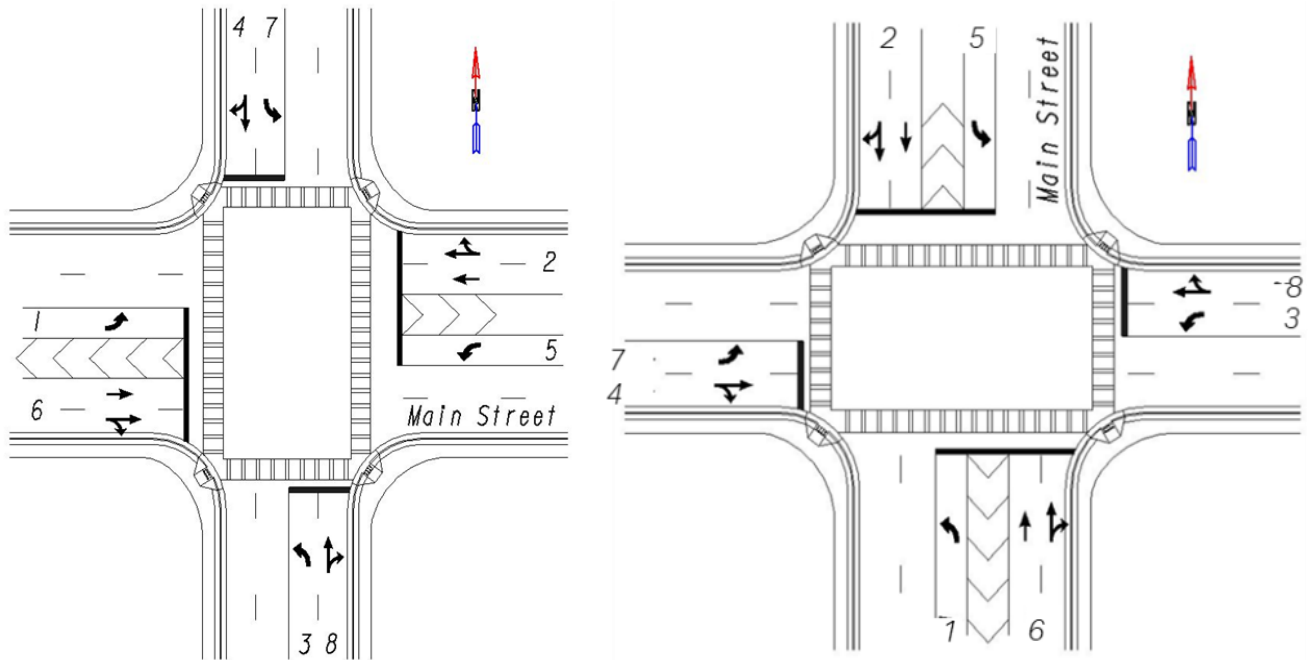

Figure 2-4: Typical Phasing Schemes for an Intersection

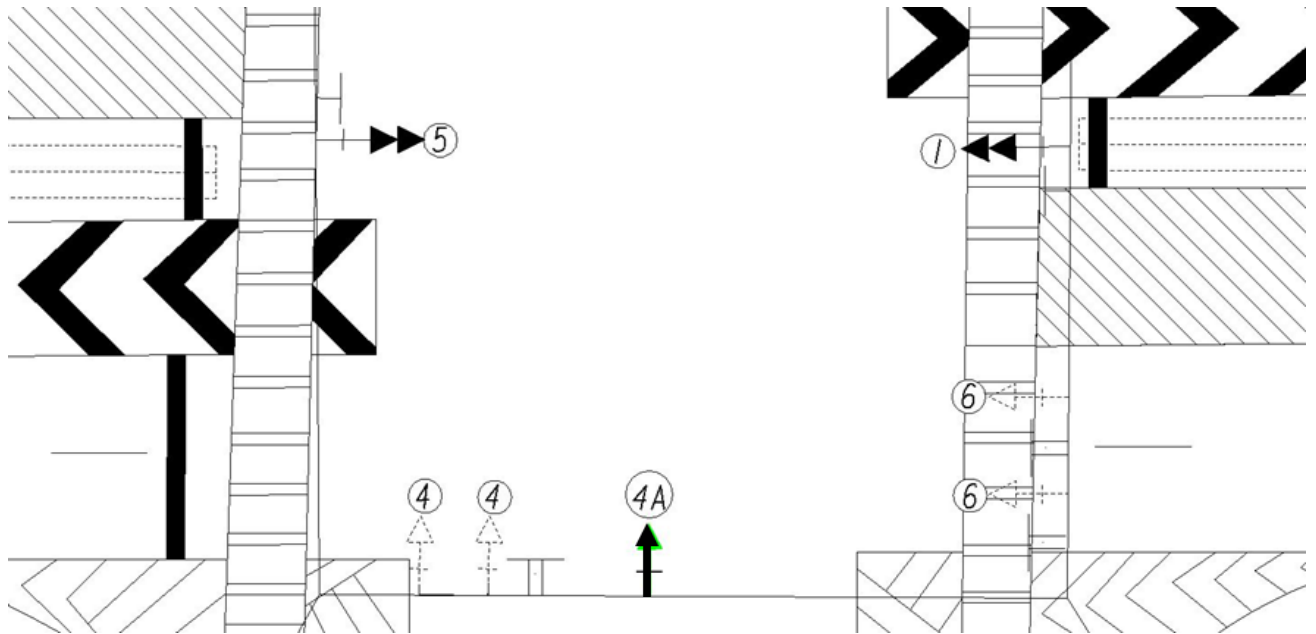

Figure 2-5: Example of Signal Face Phase Numbering

The standard phase numbering system, as illustrated on **Figure 2-6(A)**, should be used to designate signal phases at each intersection. It should be noted that the word “OMIT” should be placed in a phase that is not being used in the dual ring diagram as illustrated in **Figure 2-6(B)**.

Application

- Traffic signal phasing is essential for the contractor to properly wire the traffic signal and provide intended operation.

Design Considerations

- In cases of legacy signal systems, arterial or downtown street grids, the maintaining agency may prefer to keep signal phasing of a new or reconstructed intersection consistent with the surrounding system.

2.7.1 Left-Turn Phasing

Under standard (concurrent) phasing, the odd phases (1, 3, 5, and 7) are reserved for left-turn movements. Left-turn phases should be used only when a left-turn lane exists and sufficient justification for the left-turn phase exists. (See GDOT Traffic Signal Operations Guide for left-turn phase warrants criteria for justifying left-turn phase: Note: GDOT Traffic Signal Operations Guide is currently under process of preparation and publication). **Figure 2-6** illustrates examples of vehicle and pedestrian phasing within the structure of a dual ring diagram.

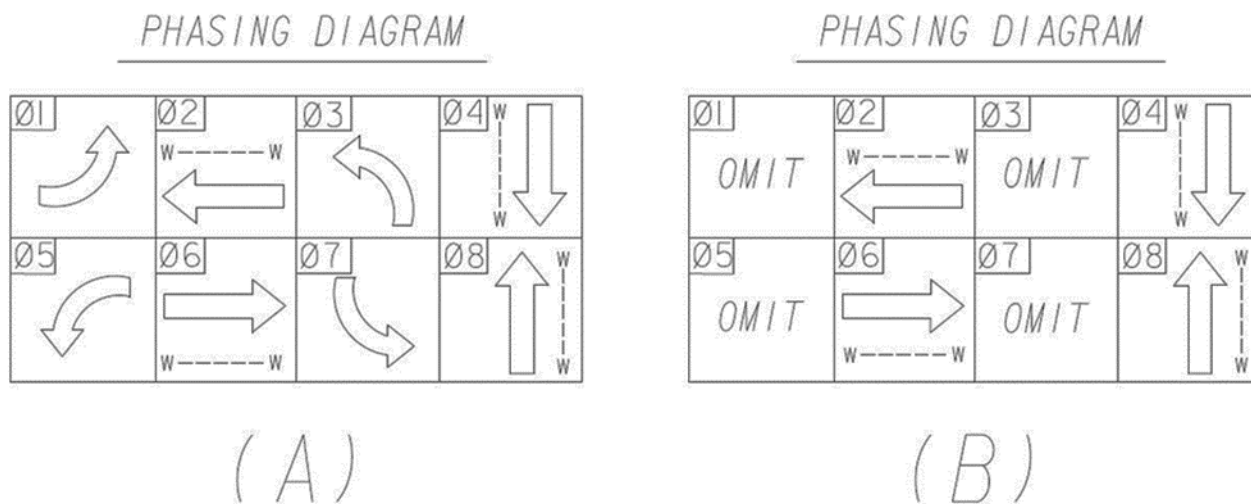

Figure 2-6: Dual Ring Diagram Typical Phasing Examples

Four-section flashing yellow left-turn arrow (FYA) heads are the preferred signal face where protected/permissive left-turn operation is warranted, A three-section bi-modal FYA signal traffic signal face may be used where adequate clearance over the roadway cannot be achieved.

GDOT does not install left-turn phases in a symmetrical manner. For example, if the northbound intersection approach warrants the installation of a left-turn phase, the opposing southbound movement should not receive a left-turn phase by default. An opposing, unwarranted left-turn movement shall have a three-section FYA permissive only signal face installed to avoid introducing a left-turn trap.

Similarly, a left-turn trap can be created at T-intersections for U-turn movements opposing the left-turn lane. One of the following options should be selected to eliminate this safety concern (in order of preference):

1. If a U-turn lane currently exists or can be reasonably accommodated, install a U-turn permissive only FYA signal traffic signal face to the opposing approach.
2. If a U-turn lane does not currently exist, consider installing a U-turn lane with a U-turn permissive only FYA signal head.
3. If a U-turn lane cannot be accommodated, install a “NO U-TURN” sign (R3-4) for the opposing approach on the span or mast arm.
4. If a U-turn lane cannot be accommodated but the U-turn movement cannot be restricted, add note under phasing diagram that the FYA must be constrained to a leading phase.

Lead/lag phasing for protected/permissive left turns shall only be controlled by FYA signal faces. Lead/lag phasing with five-section protected/permissive signal faces introduces a left-turn trap.

2.7.2 Right-Turn Overlap

Right-turn overlaps for exclusive turn lanes can be assigned to any non-conflicting phase. GDOT recommends the use of either a five-section traffic signal face or four-section FYA traffic signal face (with right facing arrows) when a right-turn overlap is used. Right-turn overlaps should be shown operating with the corresponding parent phase in the phasing diagram as shown on Figure 2-7. The overlap label should contain a sequentially increasing number to denote each overlap at the intersection such as OL1, OL2, etc.

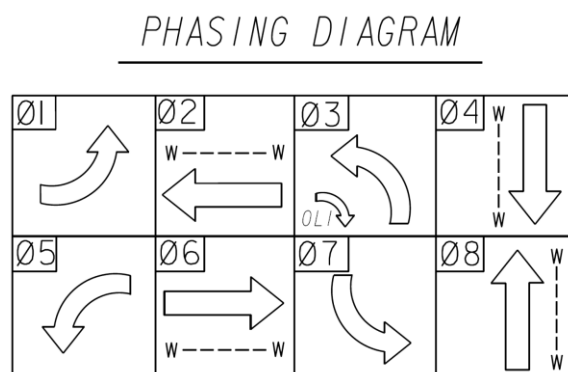

Figure 2-7: Right-Turn Overlap Orientation

Application

- Right-turn overlaps can reduce delay for high-volume right turns.

Design Considerations

- Right-turn overlaps operate well when paired with left-turn phase utilizing significant amounts of green time.
- U-turns from the parent left-turn phase must be prohibited. The U-Turn conflicts with the protected right arrow displayed during the overlapped phase.
- Right-turn overlaps cannot be combined with a yield sign for right turning traffic. Requires stop bar and movement becomes right turn on red.

2.7.3 Split Phasing

Split phasing may be implemented in cases where it provides more efficient or safe operation with certain combinations of volume and/or intersection geometry. Split phasing should be used only when specifically required, since split phasing is likely to have an adverse effect on the capacity potential for the intersection as a whole. The traffic signal face arrangements for split phasing are different from

that used for concurrent phasing. Phase 3 and Phase 4 are typically used for the split phasing of side streets, as shown in **Figure 2-8**. Using phases 3 and 4 is preferred because they are inherently exclusive using the standard NEMA phasing scheme and, therefore, safer. They cannot cause a conflict for the intersection. Side street phases should not be assigned by directional or counter-clockwise methods typically used in concurrent phasing.

Application

- Split phasing allows for increased left-turn capacity by sharing the through and left-turn lane on the minor street.

Design Considerations

- Split phasing introduces two independent pedestrian crossings for the minor street phases. This can be inefficient in areas with long and frequent pedestrian crossings.
- Operationally, it may benefit the intersection to serve the lower volume of the split phases first, so it is recommended to assign phase 3 in this example to the lower volume roadway and phase 4 to the higher volume roadway.

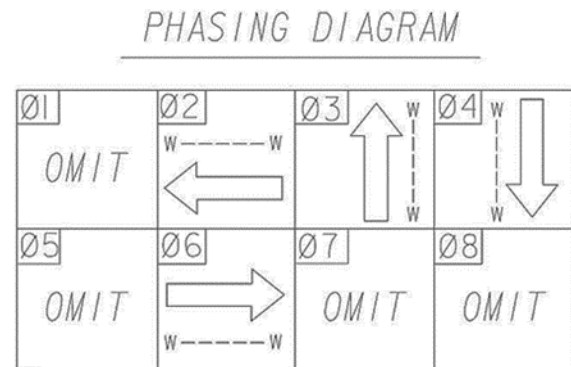

Figure 2-8: Split Phasing Orientation

2.8 Pre-emption

Pre-emption is used to clear traffic in advance of a high-priority vehicle. Common pre-emption applications include railroad pre-emption and emergency vehicles (first responders) pre-emption.

2.8.1 Railroad Pre-Emption

When a signalized intersection approach is located within 200 feet of railroad at-grade crossings, consideration should be given to establishing pre-emption operation (see [Section 8C.09](#) of the MUTCD). Furthermore, the FHWA [Railroad-Highway Grade Crossing Handbook](#) states that any traffic signals in close proximity to highway-railroad grade crossings should include provisions for railroad pre-emption to clear queued vehicles off the grade crossing prior to an arriving train.

When railroad pre-emption is used, the phasing diagram shall present the pre-emption sequence in addition to regular signal operation. **Figure 2-9** is an example traffic signal phasing diagram featuring railroad pre-emption. The pre-emption operation shall include two phases:

1. Track clearance will display a protected phase for the approach where the train will pass and should not include the associated walk phase to ensure that vehicles are able to clear the track without delay. Note: if this approach does not warrant a left-turn phase, a signal head may still be installed that includes a green left arrow to only be utilized during the track clearance phase.
2. Pre-Empt Hold, which will cycle through any phases at the intersection that do not conflict with the RR track. This may include through movements or left-turning movements at the intersection.

PHASING DIAGRAM

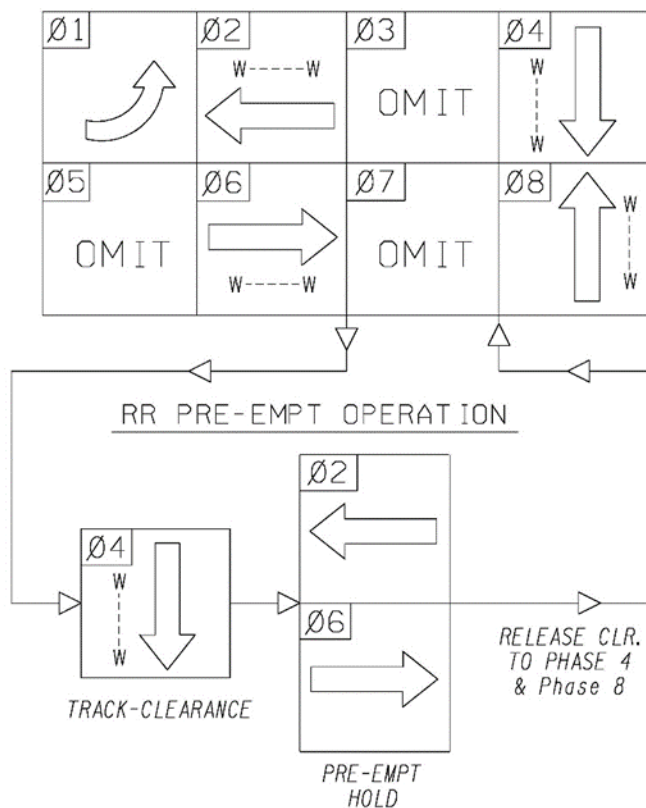

PHASING NOTES:
 1. THE PHASE 1 SIGNAL HEAD SHALL DISPLAY RED LEFT-TURN ARROW DURING THE PRE-EMPT HOLD.
 2. THE LEFT-ARROW FOR THE PRE-EMPT PHASE SHALL ONLY DISPLAY DURING THE TRACK CLEARANCE PHASE.

Figure 2-9: Example of Pre-emption for Railroads

Note: Track clearance and pre-empt hold phases are determined on a case by case basis.

Blank-out signs or dedicated signal heads should be used to prohibit permissive turn movements across railroad tracks during pre-emption. For example, a left-turn signal face shall display a solid red arrow during the pre-emption sequence. A blank-out sign displaying the [R3-2](#) sign may be installed in lieu of a left-turn signal head, but this is not preferred.

Conduit and a pull box at the edge of the railroad right-of-way should be shown on plan sets. All conduit to this pull box shall be GRS lead-in cable for railroad pre-emption. In some instances, the railroad company will install a junction box at the edge of its right-of-way with an output from the train detection device.

Battery backups shall be installed at all intersections with railroad pre-emption.

Designers of any traffic signal with railroad pre-emption are required to coordinate with the railroad section within GDOT's Office of Utilities.

2.9 List of Materials and Pay Items

A list of materials and quantities should be shown on a separate plan sheet. The following statement should be added to the list of materials plan sheet, “NOTE: QUANTITIES ARE FOR INFORMATION ONLY. THE CONTRACTOR SHOULD FIELD VERIFY PRIOR TO BIDDING TO REDUCE NEED FOR SUPPLEMENTAL AGREEMENT.”

For more information on furnishing materials and installing a traffic signal, refer to [Section 647](#).

Payment for this work is defined in [Section 647](#). Lump sum prices should include all items unless specific pay items are designated in the plans. The current list of materials is available from the [Office of Traffic Operations](#).

2.10 CAD Elements

The GDOT cell library has a variety of cells designed to convey standard information for specific pieces of equipment. **Table 2-1** presents the Legend Items of Traffic Signals shows different cell styles and some of the more common traffic signal related items.

Table 2-1: Legend Items of Traffic Signals

EXISTING	PROPOSED	RELOCATED	AGENCY SPECIFIC
CONTROLLER CABINET	CONTROLLER CABINET	3 SECTION FACE W/BACKPLATE	PROPERTY LINE
STRAIN POLE	STRAIN POLE	4 SECTION FACE W/BACKPLATE	EXIST. R/W LINE
TIMBER POLE	TIMBER POLE	4/5 SECTION (CLUSTER/T-SHAPE) FACE W/BACKPLATE	REQ'D R/W LINE
DOWN GUY	DOWN GUY	PEDESTAL POLE	CONSTRUCTION CUT LIMIT
MAST ARM	MAST ARM	PED SIGNAL FACE	CONSTRUCTION FILL LIMIT
STREET LIGHT	STREET LIGHT	CURB CUT RAMP	EASEMENT FOR CONSTRUCTION & MAINTENANCE OF SLOPES
3 SECTION FACE	3 SECTION FACE W/BACKPLATE	PULLBOX, (TYPE TO BE CALLED OUT)	EASEMENT FOR CONSTR OF DRIVES
3 SECTION FACE W/BACKPLATE	4 SECTION FACE	DIPOLE INDUCTANCE LOOP (SIZE TO BE CALLED OUT)	BEGIN LIMIT OF ACCESS
4 SECTION FACE	4/5 SECTION (CLUSTER/T-SHAPE) FACE	QUADRUPOLE INDUCTANCE LOOP (SIZE TO BE CALLED OUT)	END LIMIT OF ACCESS
4 SECTION FACE W/BACKPLATE	4/5 SECTION (CLUSTER/T-SHAPE) FACE W/BACKPLATE	VIRTUAL DETECTION ZONE (RADAR, VIDEO, ETC.)	REQ'D LIMIT OF ACCESS
4/5 SECTION (CLUSTER/T-SHAPE) FACE	OVERHEAD SIGN	CONDUIT, (TYPE TO BE CALLED OUT)	REQ'D LIMIT OF ACCESS & R/W
4/5 SECTION (CLUSTER/T-SHAPE) FACE W/BACKPLATE	PEDESTAL POLE	CONDUIT, DIRECTIONAL BORE	ORANGE BARRIER FENCE
OVERHEAD SIGN	PED SIGNAL FACE	RAILROAD CONTROLLER CABINET	ESA - ENV. SENSITIVE AREA (SEE ERIT TABLE)
PEDESTAL POLE	CURB CUT RAMP, (TYPE TO BE CALLED OUT)	SIGN POST	
PED SIGNAL FACE	PULLBOX, (TYPE TO BE CALLED OUT)	RADAR DETECTION DEVICE	
CURB CUT RAMP, ALL TYPE	DIPOLE INDUCTANCE LOOP (SIZE TO BE CALLED OUT)	MAGNETOMETER DETECTION DEVICE	
PULLBOX, (TYPE TO BE CALLED OUT)	QUADRUPOLE INDUCTANCE LOOP (SIZE TO BE CALLED OUT)	VIDEO DETECTION DEVICE	
DIPOLE INDUCTANCE LOOP (SIZE TO BE CALLED OUT)	VIRTUAL DETECTION ZONE (RADAR, VIDEO, ETC.)		
QUADRUPOLE INDUCTANCE LOOP (SIZE TO BE CALLED OUT)	CONDUIT, (TYPE TO BE CALLED OUT)		
VIRTUAL DETECTION ZONE (RADAR, VIDEO, ETC.)	CONDUIT, DIRECTIONAL BORE		
CONDUIT, ALL TYPE	RAILROAD CONTROLLER CABINET		
RAILROAD CONTROLLER	SIGN POST		
SIGN POST	RADAR DETECTION DEVICE		
RADAR DETECTION DEVICE	MAGNETOMETER DETECTION DEVICE		
MAGNETOMETER DETECTION DEVICE	VIDEO DETECTION DEVICE		
VIDEO DETECTION DEVICE			

Refer to the current traffic signal legend for a complete listing of traffic signal CAD elements.

Chapter 3. Traffic Signal Poles - Contents

- Chapter 3. Traffic Signal Poles - Contents.....3-i
- 3.1 Pole Placement3-1
- 3.2 Pole Types.....3-1
 - 3.2.1 Mast Arm Poles3-2
 - 3.2.2 Strain Poles3-3
 - 3.2.3 Joint Use (Utility) Poles3-3
 - 3.2.4 Timber Poles3-4
- 3.3 Span Wire Configuration3-4

Chapter 3. Traffic Signal Poles

The selection and placement of traffic signal support poles is a fundamental and critical step of the traffic signal design process. Traffic signal poles suspend the traffic signal faces over the intersection. GDOT allows several traffic signal support pole types, depending on the field conditions, traffic control requirements, and aesthetic preferences.

3.1 Pole Placement

The clear zone requirements that apply to non-breakaway traffic signal poles are located in the current edition of the AASHTO [Roadside Design Guide](#). The GDOT [Design Policy Manual](#) should also be used for locating traffic signal poles in regards to clearzone or lateral offset.

Traffic signal poles may be placed within the clear zone for limited circumstances. Some examples of these limited circumstances include, with the approval of GDOT:

- Steep roadside slopes
- Substantial utility conflicts
- Presence of existing guardrail, such that the existing guardrail is appropriately located to shield the proposed traffic signal pole. When a proposed traffic signal pole is located behind an existing guardrail, the pole placement should account for the appropriate design deflection for the guardrail. Poles should not be placed closer than 5ft from the front face of the guardrail to the front face of the pole.
- In some cases, right-of-way limitations; under normal circumstances, additional right-of-way should be acquired. Limited right-of-way is not recommended as a default design decision for placing a pole within the clear zone.

Pole placement should be indicated on the plans by station and offset when the base roadway plans display the construction centerline and stationing. In some cases, the centerline layer through the intersection can be difficult to discern. Care should be taken to preserve the visibility of the centerline layer. The 100-foot tick marks noting rounded stations can remain turned on. For a stand-alone signal design plan set, the construction centerline layer should be turned off.

Design Considerations

- All existing pole and type (strain, timber, or joint use) poles shall be called out on the signal plan sheet. GDOT prefers to limit the number of poles per corner by removing old poles and considering joint use poles.
- The designer should survey the area for existing above ground and subsurface utilities to avoid conflicts.
- Poles should not be placed closer than 5 ft from the front face of the guardrail to the front face of the pole.

3.2 Pole Types

Multiple types of poles are available for supporting traffic signals.

Intersection geometry, underground utilities, available right-of-way, and appropriate vehicular signal face placement should be considered to determine the suitable pole type. The typical vehicular signal face placement scenarios are presented in *Appendix A: Traffic Signal Plan Examples*.

3.2.1 Mast Arm Poles

Mast arm poles are preferred for all new traffic signal installations and upgrade installations, except for rural applications. For additional information, see the [Mast Arm Guidance Memo dated December 10, 2019](#). Other support types may be considered if the cost and/or application of mast arm poles is impractical. Decorative mast arms are allowed; however, they are not included as part of the GDOT standard installation and the local agency will be required to cover the additional expenses.

[Section 647](#) requires the contractor to submit pole and foundation structural calculations and shop drawings for GDOT review and approval.

The design process for mast arm poles requires the designer to determine the length of mast arm necessary to locate the traffic signal face in the appropriate position, and to maintain compliance with clear zone requirements. Mast arm applications may use either one arm or two arms per pole. Poles that have two arms usually require a larger diameter pole and are more expensive than a pole supporting one arm; however, fewer poles are needed per intersection. The design should provide enough room to construct a large pole foundation, which are typically 4 feet in diameter and can have a depth of 18 feet or more.

Mast arms are manufactured for a variety of lengths, and the typical lengths are between 20 feet and 65 feet long in 5 feet increments. The proposed length for each mast arm should be called out on the signal plan sheet. The maximum mast arm length is 65 feet long as per [Policy and Procedure 4270-1](#).

Mast arms can be beneficial at intersections with overhead utilities and can allow the designer to avoid certain corners by utilizing tandem mast arms and to ensure offsets from utilities are met, because the mast arm is relatively static.

Application

- Mast arms are GDOT's preferred pole type for new and upgrade signal locations where applicable.

Design Considerations

- The designer should investigate subsurface conditions to avoid conflicts with utilities, drainage systems, etc.
- The designer should investigate aerial conditions to avoid conflicts with overhead lines. The designer should coordinate with local utilities for required horizontal and vertical clearances from overhead utility lines.
- Provide distance from stop bar to vehicular signal faces per the [MUTCD](#).
- The design should provide for signal face placement to serve future traffic signal phases and/or lane configuration changes (e.g., left-turn phase and/or lane additions, Type A to B median conversions for offset left turns, planned widening projects).

- When possible, place traffic signal pole in a location suitable for attaching pedestrian pushbuttons and/or pedestrian signals, to minimize traffic signal infrastructure.

3.2.2 Strain Poles

Span wire configurations should be used if mast arm lengths of 65 feet or less do not provide proper placement of traffic signal faces or if the mast arm pole placement is undesirable.

Traffic signal strain poles are specified as Type IV poles in accordance with [Section 639](#) and [Section 647](#). These specifications require the contractor to submit pole and foundation structural calculations and shop drawings to the GDOT districts for review and approval.

Application

- Use in rural locations or when a 65-foot mast arm length is not sufficient to properly place signal faces.
- Strain pole types include steel and reinforced concrete.
- The designer may specify the pole type by local preference, otherwise the contractor can choose the pole type based on cost and/or preferred means and methods of installation.
- All new poles placed at an intersection shall be the same type and material.
- For signal modifications involving partial upgrade, the new strain poles shall match the existing poles that will remain. Note: Existing timber poles should be replaced.

Design Consideration

- Provide distance from stop bar to vehicular signal faces per the [MUTCD](#).
- The designer should investigate subsurface conditions to avoid conflicts with utilities, drainage systems, etc.
- The designer should investigate aerial conditions to avoid conflicts with overhead lines. The designer should coordinate with local utilities for required horizontal and vertical clearances from overhead utility lines.
- When possible, place traffic signal pole in a location suitable for attaching pedestrian pushbuttons and/or pedestrian signals, to minimize traffic signal infrastructure.

3.2.3 Joint Use (Utility) Poles

Joint use poles are utility poles owned by utility companies that support traffic signal spans. Recommendations for new joint use poles should be coordinated through the Office of Utilities and utility companies. Joint use poles typically result in a span wire configuration, but joint use mast arms are an option.

The designer may be required to provide load calculations to the utility company.

For more information on joint use of utility facilities refer to Section 4.7 of the GDOT [Utility Accommodation Policy and Standards](#).

Application

- Office of Traffic Operations prefers joint use poles to be used as a last resort to support a traffic signal span to ensure complete access to traffic signal infrastructure for maintenance and future upgrades

Design Consideration

- Timber utility poles are not recommended for joint use since additional soil anchors are needed.

3.2.4 Timber Poles

Timber poles are most commonly used for temporary signals or to attach overhead conductors or communications. These situations are primarily driven by timing. A temporary traffic signal may be deemed necessary to address a safety problem or development need where an immediate solution is needed in advance of other projects (scheduled or delayed) that will install permanent traffic signals.

As part of a permanent traffic signal installation, where trenching or boring conduits is not feasible, timber poles may be used to bridge loop detector leads, power service, or communication drops.

Application

- Class II timber poles should be specified when timber poles are used for signal spans.
- Class IV timber poles may be used only for supporting aerial loop lead-in wire or communications cable.

Design Consideration

- At the District Office's discretion, the use of timber poles may be used at locations where the available right-of-way accommodates clear zone requirements and ground anchors (guy wires).

3.3 Span Wire Configuration

Span wire configurations allow additional options for placing signal faces in the optimal viewing position and provide more flexibility with respect to the location of traffic signal support poles. In particular, span wire configurations allow a greater range for pole placement outside the clear zone for wide roadway cross sections located in rural areas.

Application

- The preferred and common type of span wire configuration is the modified box span. Poles are placed in each of the four intersection quadrants, and the span wire is strung in a manner that the box span is "suspended" over the intersection.
- The signal face is attached to the span wire and is centered over the receiving lane.

Design Considerations

- Span wire configurations should be designed to allow for 17-ft minimum and 19-ft maximum signal face vertical clearance; from the pavement to the lowest part of the assembly, including brackets and backplates.

- A “helper” cable (secondary support span) may be required on timber supported span wire arrangement where a span length exceeds 150 feet (measured pole to pole). A note should be made in the general notes plan sheet when helper cables are required.
- Adequate clearance should be provided for future addition of vertical four-section, such as flashing yellow arrow (FYA) or left-turn signal face used for split phase operation.
- Other options are the box span, diagonal span, H-span, Z-span, and X-span. These are described in detail in the ITE [Manual of Traffic Signal Design](#). These alternative span configurations should only be used with specific guidance from GDOT.
- Span wire should be designed to meet minimum sag requirements. Sag is the amount of vertical drop measured from the pole attachment point to the lowest part of the span.
- Span wire shall meet minimum sag requirements specified by the pole manufacturer (typically minimum 5% sag for strain pole and minimum 2.5% sag for timber pole) Allowable sag is calculated by measuring the longest distance between poles and multiplying by the desired percentage of sag, unless otherwise specified by the pole manufacturers.
- Calculate attachment points for the messenger strand at the signal pole according to the Standard Detail Drawings.

Intentionally Left Blank

Chapter 4. Pedestrian Infrastructure - Contents

- Chapter 4. Pedestrian Infrastructure - Contents4-i
- 4.1 Marked Crosswalks4-1
- 4.2 Curb Ramps and Concrete Landing Pads.....4-2
- 4.3 Pedestrian Signal Faces.....4-3
- 4.4 Pedestrian Detection4-3
- 4.5 Pedestrian Refuge Areas4-4
- 4.6 Pedestrian Signs4-5
- 4.7 Pedestrian Hybrid Beacons4-7
- 4.8 Rectangular Rapid Flashing Beacon4-8
- 4.9 Accessible Pedestrian Signals (APS).....4-9

Chapter 4. Pedestrian Infrastructure

GDOT Traffic Signal Policy 6785-1 states: “Crosswalks and pedestrian signal faces including [ADA](#) considerations, shall be installed on all approaches of new traffic signal installations or revised traffic signal permits unless an approach prohibits pedestrian traffic.”

Based on the policy, the following pedestrian infrastructure should be provided at signalized intersections under the jurisdiction of GDOT, except where approved by the State Traffic Engineer. Justification for not providing pedestrian accommodations for all approaches should be documented in the signal permit file.

Pedestrian infrastructure at signalized intersections includes the following:

- Marked crosswalks
- Curb ramps or concrete landing pads
- Refuge islands
- Pedestrian signal faces
- Pedestrian detection

This chapter provides design guidance for pedestrian accommodations at traffic signals and other pedestrian focused traffic control devices, such as PHBs and RRFBs. Refer to the GDOT [Pedestrian and Streetscape Guide](#) for additional information about the design of the pedestrian crossing.

4.1 Marked Crosswalks

Crosswalks are areas designated for pedestrians to cross the street. Marked crosswalks provide an indication to pedestrians as to where they should cross the street and to motorists as to where pedestrians are likely to be crossing the street.

Application

- Crosswalks at intersections under the jurisdiction of GDOT should be installed on each approach of a signalized intersection, except where approved by the State Traffic Engineer with provided justification.

Design Considerations

The crosswalk pavement marking materials should comply with the GDOT standards, which include visibility, reflectivity, and skid resistance requirements.

- Crosswalks should provide the most direct connection between sidewalks or shared use paths.
- Crosswalks should align with the corresponding curb ramp.
- Crosswalks should extend the full width of the roadway.
- Crosswalks should be a minimum of 8 feet wide. Drainage inlets should be located on the uphill side of crosswalks and curb ramps to reduce the amount of water flowing across the crosswalk.

- Crossings constructed with special paving should use non-slip bricks and/or unit pavers. The special paving layout and/or colors do not replace the need for standard pedestrian crosswalk pavement markings.
- Scored or stamped and colored concrete surfaces may be used in conjunction with the appropriate pavement markings.

4.2 Curb Ramps and Concrete Landing Pads

Curb ramps provide access on and off the sidewalk for pedestrians of all abilities. Curb ramps connect the pavement to sidewalk grade, and may be perpendicular or parallel to the roadway, or a combination of the two.

Application

- For each approach where crosswalks are provided, ADA compliant curb ramps should be provided.
- In rural areas, where sidewalks are not provided, an ADA compliant concrete pad should be installed for each crosswalk approach.
- Curb ramps should be installed on medians or channelizing islands that serve as pedestrian refuge areas unless a cut-through (an at-grade opening) with a traversable surface is provided.

Design Considerations

- Curb ramps should comply with GDOT Construction Details A-3 and A-4.
- The level landing area at the top or bottom of each curb ramp shall be 4 feet by 4 feet, with a maximum 2 percent running slope, measured parallel to the direction of pedestrian travel.
- The low end of the curb ramp should meet the grade of the street with a smooth transition.
- At locations where there is sufficient space, perpendicular curb ramps are preferable to parallel curb ramps.
- Perpendicular curb ramps should have flat flared sides with a maximum slope of 10 percent, measured parallel to the curb line and a 4-ft by 4-ft landing area at the top of the curb ramp.
- At locations where there is not sufficient space to provide a 4-ft by 4-ft landing area at the top of the curb ramp, a parallel curb ramp should be used.
- Parallel curb ramps should have a running slope that is in-line with the direction of sidewalk travel and a 4-ft by 4-ft landing area at the bottom of the ramp.
- All curb ramps or pads shall include an ADA detectable edge that extends the full width of curb ramp (exclusive of the flared sides) and is a minimum of 24 inches wide, measured from the edge of the curb closest to the street. Refer to PROWAG and Section 3.3.5 of the GDOT Pedestrian and Streetscape Guide for more information on the design of ADA detectable edges.
- Curb ramps should align with and be fully incorporated within the corresponding crosswalk.

- Drainage inlets should be located on the uphill or high side of all crosswalks and curb ramps to reduce the amount of water flowing across the crosswalk

4.3 Pedestrian Signal Faces

All pedestrian signal faces shall be 18-inch LED indications with countdown included. Pedestrian signal faces may be installed on utility poles, span wire poles, mast arm poles, or pedestrian pedestal poles.

- Pedestrian signal faces shall be mounted with the bottom of the signal housing, including brackets, not less than 7 feet or not more than 10 feet above sidewalk level and shall be positioned and adjusted to provide maximum visibility at the beginning of the controlled crosswalk.
- The pedestrian signal face shall be visible through the entire length of the crosswalk. See Section 4E of the [MUTCD](#) for further information on placement of pedestrian signal faces.
- If the crosswalk runs through a raised median and the pedestrian signal faces cannot be seen for the entire length of the crossing, supplemental pedestrian signal faces should be placed in the raised median facing each direction.

4.4 Pedestrian Detection

Pedestrian detection devices provide a means for pedestrians to request service by the traffic signal. The most common form of pedestrian detection is the pedestrian pushbutton, which is an active detection device.

A pushbutton requires the pedestrian to physically push a button to receive the WALK signal and is the most common form of pedestrian detection.

Application

- Pedestrian pushbutton assemblies should be installed at all signalized intersections. Pedestrian pushbutton assemblies may be omitted in downtown areas with pretimed networks (i.e. pedestrian phases on 24-hour recall).
- Pedestrian pushbutton assemblies should be installed on both ends of a crosswalk at signalized intersections and mid-block crossing locations with pedestrian signals, PHBs, or RRFBs.
- Pedestrian pushbutton assemblies should be provided in pedestrian refuge areas at locations with a two-stage pedestrian crossing and where pedestrians may not be able to cross the entire street in one traffic signal phase.
- Pedestrian pushbutton assemblies are also used to actuate PHBs (See Section 4.7) and RRFBs (See Section 4.8).
- Type A or Type B pushbutton should be used:
 - Type A: a piezo driven solid-state switch used to send pedestrian actuations (contact closures) to the traffic signal controller,

- Type B: an accessible pedestrian detector with electronic control equipment, wiring, mounting hardware, pushbuttons, and pedestrian actuation signs designed to provide a pushbutton with a raised, vibrating tactile arrow and audible indications for differing pedestrian signal functions. (Refer to Section 4.9 of this document for more detail about the installation of APS)

Design Consideration

- A pedestrian pushbutton assembly may be mounted on a traffic signal pole or on a free-standing pole.
- The pole on which the pedestrian pushbutton is mounted should not block the pedestrian access route or curb ramp.
- Pedestrian pushbuttons should be located no more than 5 feet from the edge of curb ramp ([MUTCD](#) Section 4E.08).
- Pedestrian pushbuttons should be offset 1.5 to 6 feet from the edge of the curb, shoulder, or pavement. ([MUTCD](#) Section 4E.08).
- Pedestrian pushbuttons should be mounted 3.5 to 4 feet above the pavement ([MUTCD](#) Section 4E.08).
- Pedestrian pushbuttons should be mounted such that it is clear which crosswalk is associated with the pushbutton operation.
- Pedestrian pushbuttons should be mounted such that a person in a wheelchair at the top of a curb ramp can access the button.
- The traffic signal operation may be programmed to provide automatic pedestrian phase service, even if pedestrian detection is present.

4.5 Pedestrian Refuge Areas

Pedestrian refuge areas are spaces designated for pedestrian use located between active vehicle travel lanes. Refuge areas provide a more protected pedestrian crossing and shorten the pedestrian distances, reducing the required time for crossing the perpendicular street.

Application

- Pedestrian refuge areas are most beneficial on wide intersections with high traffic volumes and significant numbers of pedestrians crossing.
- Pedestrian refuge areas should be considered at intersections where the crossing exceeds 60 feet.
- Pedestrian refuge areas should be provided at channelized right-turn lanes. These pedestrian refuge areas are commonly referred to as channelizing islands.
- Pedestrian refuge islands may be used at pedestrian crossings with RRFBs and PHBs.

Design Consideration

- Medians and center refuge areas need to be large enough to provide refuge for several pedestrians waiting at once. The anticipated pedestrian crossing function and volumes should be considered when determining the amount of refuge area.
- The width of pedestrian refuge areas between active vehicle travel lanes should be a minimum of 6 feet and preferably 8 feet or more where possible, representing the dimension of face-to-face of curb. The refuge area should be accessible using a curb ramp or an at-grade cut through. An at-grade cut-through is generally easier to construct and easier for pedestrians to negotiate than curb ramps, particularly for short refuge areas.
- Refuge areas should be raised to provide additional protection with the use of a vertical barrier between pedestrians and motor vehicles. In the case of an at-grade cut-through, the area surrounding the pedestrian path through the refuge area should be raised.
- At signalized intersections or locations with pushbutton-actuated beacons, pedestrian pushbutton assemblies and pedestrian signal face locations should provide pedestrians with the ability to make a call for the pedestrian phase from the refuge area. Pushbutton posts and other poles should be located outside of the pedestrian travel way and within a convenient distance for the pedestrian.
- If pedestrian refuge areas are installed at a PHB crossing, the refuge area should have an angled or Z-shaped (See example A-10 in Appendix A: Traffic Signal Plan Examples) cut-through that faces the pedestrian towards oncoming traffic as they are crossing.

4.6 Pedestrian Signs

The cells of pedestrian signs should be placed under the heading “Pedestrian Signs” on the plan sheet. R10-3E (PEDESTRIAN COUNTDOWN) signs should be provided to indicate the direction of crossing associated with each pushbutton.

In instances where justification exists to prohibit the installation of pedestrian crossings, either an R9-3 or R5-10c sign (NO PEDESTRIANS) should be installed along with either an R9-3bPR or R9-3bPL sign (SUPPLEMENTAL ARROW) to designate the direction of the crossing. An example installation for these signs is shown on **Figure 4-1**.

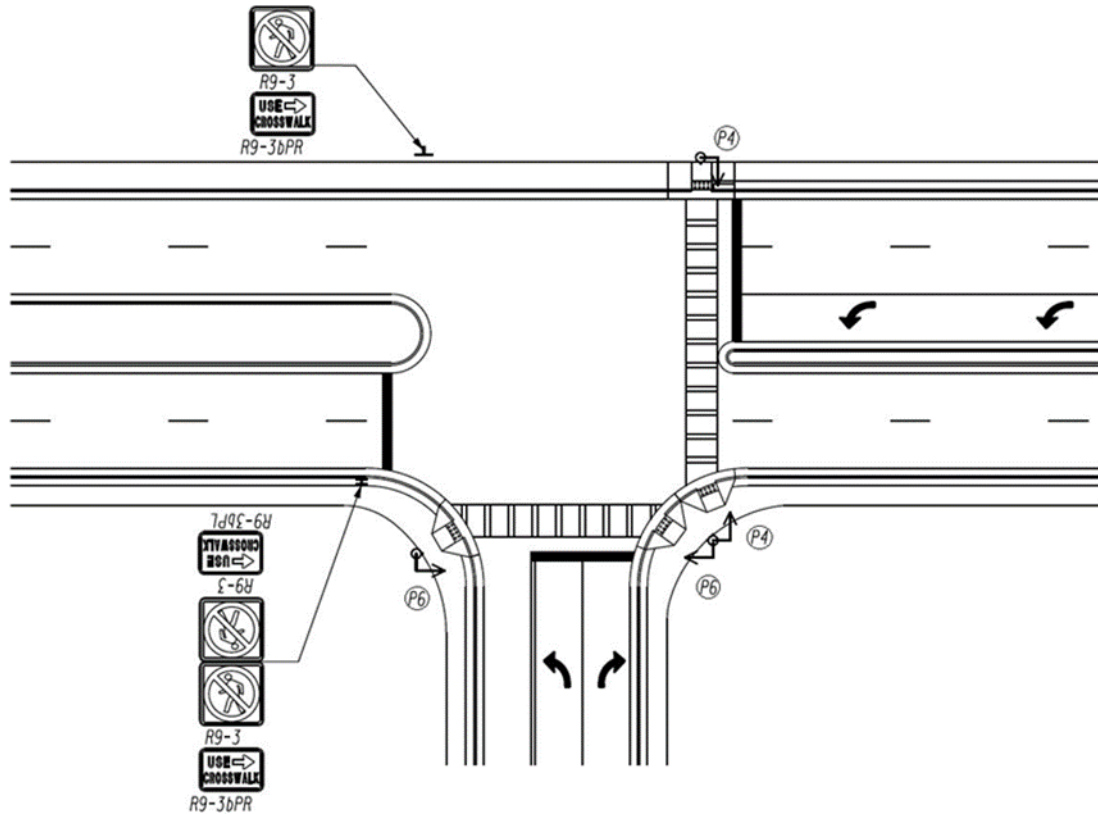

Figure 4-1: Prohibited Pedestrian Crossing Treatment

Note: Signs should be placed approximately where the pedestrian signal traffic signal face would have been located if a crosswalk was present. For further guidance see the GDOT [Signing and Marking Design Guidelines](#).

Elongated pedestrian refuge islands, shown on **Figure 4-2**, provide a better angle for driver visibility. This design should be used when installing or reconstructing concrete islands for channelized right turns. The elongated tail design improves the angle between the turning vehicle and the oncoming traffic to which the turning vehicle should stop or yield, which otherwise requires a driver to turn their head to an angle that is either uncomfortable or difficult for some drivers. The elongated tail design improves the pedestrian environment and the driver environment as compared to a simple radius curve.

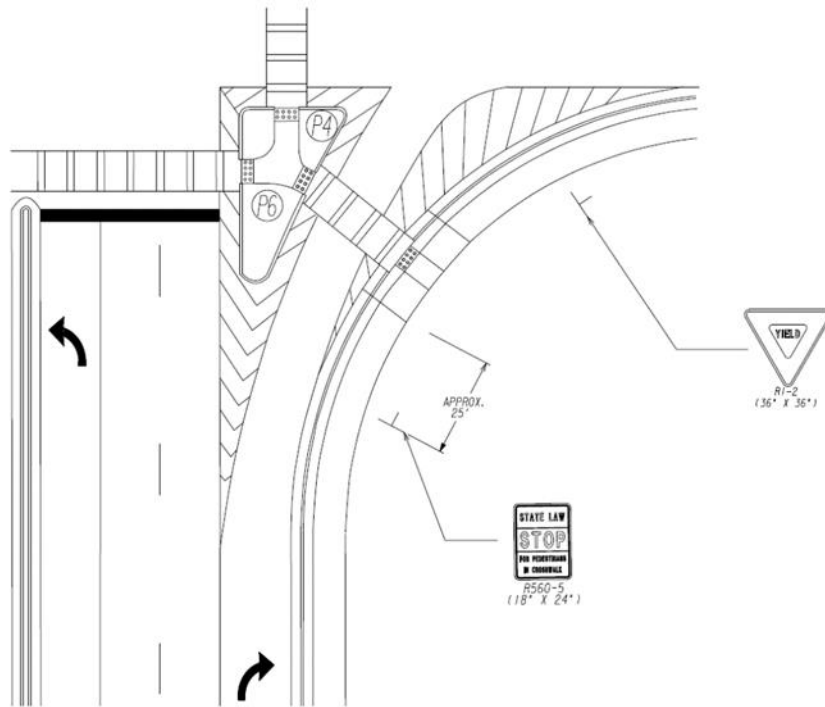

Figure 4-2: Elongated Tail Design for a Pedestrian Refuge Area

The signing requirements for marked pedestrian crossings associated with exclusive right-turn lanes at signalized intersections are as follows:

- Typical post-mounted signs that appear on a signal design plan sheet (for permitting purposes) are the R560-5 signs (STATE LAW STOP FOR PEDESTRIANS IN CROSSWALK) and R1-2 signs (YIELD). These signs should be used at all signalized locations that have free-flowing or yield-controlled right-turn channelized islands.
- If a physical (raised concrete) island is provided, an R1-2 sign shall be installed for the right-turn lane if there is no dedicated receiving lane. The location of the R560-5 and R1-2 signs is found in Figure 4 2. The R1-2 sign does not require supplemental pavement markings.
- If no physical (raised concrete) island is provided, a stop bar should be extended across the right-turn lane, an R1-2 sign (YIELD) should not be installed, and the R560-5 sign is not required.

4.7 Pedestrian Hybrid Beacons

A PHB, also known as a as a Pedestrian Hybrid Beacon, is a traffic control device used to stop vehicles at uncontrolled mid-block pedestrian crossing locations. An engineering study should be performed that includes site-specific conditions, and the guidance provided in this section may be used to guide the engineering study.

Application

- PHBs may be installed at uncontrolled mid-block pedestrian crossing locations ([MUTCD Chapter 4F](#)).

- PHBs may be installed on streets with an 85th percentile speed of 45 mph or less.
- PHBs may be installed on two-way streets with four or less lanes in each direction.
- PHBs may be installed on one-way streets with four or less lanes.
- Refer to [MUTCD](#) Chapter 4F for pedestrian and vehicular volume thresholds that warrant the installation of a PHB.

Design Consideration

- The PHB should be designed in accordance with [MUTCD](#) Chapter 4F.02.
- If PHBs are installed on two-way streets with more than one lane in each direction, a pedestrian refuge island should be installed between opposing travel lanes.
- A PHB indication should be installed over each active through lane.
- Pushbuttons should be placed in accordance with this guide.
- Pedestrian refuge areas designed with a zigzag cut-through may be installed in conjunction with PHBs to break up the crossing distance and to encourage pedestrians to face on-coming traffic before crossing the street.
- On two-way streets with a pedestrian refuge area, PHB faces may be installed in the median in addition to either side of the crosswalk.
- PHBs may be installed at pedestrian crossings at two-lane roundabouts to increase driver's awareness of a pedestrian crossing.
- PHB signals may be in coordination with adjacent traffic signals or in free operation. Pedestrians are more likely to be compliant with the signal if PHB is in free operation.
- PHBs may provide the WALK phase in one or two stages.
- Depending on the environment, PHBs may create a false sense of security for pedestrians. In some cases, a median refuge area may provide the most significant safety benefit for the pedestrian.

4.8 Rectangular Rapid Flashing Beacon

RRFBs are actuated flashing lights installed with pedestrian crossing signs. RRFBs draw the driver's attention to the crosswalk and communicate the presence of a pedestrian and the need to yield. An engineering study should be performed that includes site-specific conditions, and the guidance provided in this section may be used to guide the engineering study.

Application

- RRFBs can be installed at uncontrolled pedestrian crossing locations (intersections or mid-block).
- RRFBs may be installed on streets with an 85th percentile speed of 35 mph or less.
- RRFBs may be installed on two-way streets with three or less lanes in each direction.
- RRFBs may be installed on one-way streets with three or less lanes.

Design Consideration

- RRFBs should be installed on the left and the right side of the roadway at the crosswalk.
- If a RRFB is installed on a two-way street with a pedestrian refuge area, an additional RRFB assembly should be mounted in the median.
- If a RRFB is installed on a multilane crossing without a pedestrian refuge area an additional RRFB assembly should be mounted over the travel lane for each approach
- If a RRFB is installed on a three-lane crossing with or without a pedestrian refuge area, an additional RRFB assembly should be mounted over the travel center lane for each approach.
- The RRFB should be mounted directly below the standard crosswalk or school crosswalk warning signs, including W11-2 (Pedestrian), S1-1 (School), or W11-15 (Shared-use trail crossing), and above the diagonal downward arrow (W16-7p) plaque. ([MUTCD Interim Approval 21](#))
- Pushbuttons should be placed in accordance with this guide.
- Pedestrian refuge areas may be installed along with the RRFBs to break up the crossing distance.
- RRFBs may be installed at pedestrian crossings at roundabouts to increase driver's awareness of a pedestrian crossing.
- RRFBs can be a lower cost alternative to traffic signals or PHBs.
- Depending on the environment, RRFBs may create a false sense of security for pedestrians. In some cases, a median refuge area may provide the most significant safety benefit for the pedestrian.
- Solar Power System may be used for RRFB.

4.9 Accessible Pedestrian Signals (APS)

Accessible Pedestrian Signals (APS) and detectors (Type "B" pedestrian detection) provide information in non-visual formats (such as audible tones, speech messages, and/or vibrating surfaces). Refer to the provision associated with APS in MUTCD section 4E.09 through section 4E.13 for additional detail.

If a particular signalized location presents difficulties for pedestrians who have visual disabilities to cross the roadway, an engineering study should be conducted that considers the needs of those pedestrians. The engineering study should consider the following factors:

- Potential demand for accessible pedestrian signals;
- A request for accessible pedestrian signals;
- Traffic volumes during times when pedestrians might be present, including periods of low traffic volumes or high turn-on-red volumes;
- The complexity of traffic signal phasing (such as split phases, protected turn phases, leading pedestrian intervals, and exclusive pedestrian phases); and
- The complexity of intersection geometry.

When used, accessible pedestrian signals shall be used in combination with pedestrian signal timing. The information provided by an accessible pedestrian signal shall clearly indicate which pedestrian crossing is served by each device. Under stop-and-go operation, accessible pedestrian signals shall not be limited in operation by the time of day or day of week. Type “B” pedestrian detection should be used for accessible pedestrian signals.

Application

- APS shall be required at the installation of PHBs.

Design Consideration

- APS should be considered at crosswalks longer than 70 feet, unless they are divided by a median that has another accessible signal with a locator tone.
- APS should be considered at crosswalks that are skewed.
- APS should be considered at intersections with irregular geometry, such as intersections with more than four legs.
- APS should be considered where audible beaconing is requested by an individual with visual disabilities, or near facilities that accommodate the visually impaired.
- The installation of APS should be provided at any other location where a study indicates audible beaconing would be beneficial to the safety of crossing pedestrians.

Chapter 5. Cabinet Assemblies - Contents

- Chapter 5. Cabinet Assemblies - Contents5-i
 - 5.1 Cabinet and Cabinet Bases5-1
 - 5.2 Input File and Cabinet Input Assignments5-3
 - 5.3 Uninterruptable Power Supply5-3
 - 5.4 Power Disconnect.....5-3

Chapter 5. Cabinet Assemblies

A traffic signal design plan should include installation details related to the traffic signal control cabinet. These details include the following:

- Type of cabinet
- Cabinet mounting
- Controller
- Input file
- Power disconnects
- Power backup systems, if any
- Communications devices

The following sections describe GDOT-specified items that may be required for a controller assembly.

5.1 Cabinet and Cabinet Bases



Cabinets for signal controllers should be Type 332 or 336S. The primary cabinet used by GDOT is the Caltrans Type 332L cabinet, which includes an auxiliary output file. The Type 332L cabinet should be used in most cases where a ground-mounted cabinet is feasible. Where conditions require a more compact or pole-mounted cabinet, the Type 336S cabinet may be used.

The use of a non-GDOT standard cabinet (i.e. Type 342) is allowed; however, they are not included for GDOT standard installation. A local agency choosing to install a non-standard cabinet will be required to cover the associated expenses.

Ground-mounted cabinets require a base that serves as the foundation. A standard base is appropriate for most installations. Certain types of UPS may require a secondary cabinet and larger foundation. See Section 5.3.

Table 5-1: Caltrans Cabinets and their Applications

<p>Type 332L</p> 	<p>The Type 332L cabinet is preferred for GDOT traffic signal installations. The tall body provides space for:</p> <ul style="list-style-type: none"> • Full array of input and output files (racks), including auxiliary (third) output file • Communications equipment • Some self-contained battery backup systems fit in these cabinets • Interface hardware of certain vehicle detection systems
---	---

<p>Type 336</p> 	<p>The Type 336 cabinet may be used for both pole-mounted (preferred) and ground-mounted applications. This cabinet is limited in number of detector inputs and signal face outputs. This limits the number of left-turn phases, especially the use of FYA signal faces.</p> <p>In a pole-mounted application, the Type 336 cabinet works well in downtown areas where right-of-way is limited and traffic signals operate with fewer phases. If space is available or additional right-of-way can be obtained during a project, the Type 332L cabinet is still preferred.</p>
<p>Type 342</p> 	<p>The Type 342 four-door cabinet has the same signal equipment rack as a Type 332L cabinet on one side with an open rack on the other. The additional cabinet space is useful to combine for ITS applications, communications hub, backup power systems, etc.</p>
<p>ATC</p> 	<p>Advanced Transportation Controller (ATC) cabinets are the next generation cabinet that has many advantages and safety enhancements. It has additional inputs and outputs making it suitable for operating multiple intersections from a single cabinet. The ATC cabinet improves worker safety using lower voltage. Currently, GDOT is using these cabinets at limited locations, such as railroad pre-emption sites and other testing applications around the state.</p>

Design Consideration

- Orient cabinet so that maintenance personnel can view the signal faces while facing the controller.
- Place cabinet on the approach with the lowest volume and speed to minimize exposure for maintenance personnel.
- Cabinet doors must fully open on state right-of-way. Do not position on the edge of the right-of-way.
- Cabinet assembly and technician work pad shall remain within right-of-way.
- Comply with ADA sidewalk clearance requirements. This includes when controller cabinet assembly doors are open.
- Locate on level terrain as far from the roadway as possible.
- Avoid low-lying areas prone to collecting water.

- Consider locations that protect cabinet from errant vehicles, maintenance equipment, etc.
- Do not obstruct driver's line of sight.
- Do not obstruct the sidewalk, even when the doors are open.

5.2 Input File and Cabinet Input Assignments

These diagrams are only required on traffic signal plans when non-standard input assignments are needed. Sections [925](#) and [647](#) of the GDOT specifications present the standard cabinet wiring for vehicle inputs and field installation. Changes to the standard cabinet wiring to accommodate unique situations should be accomplished through input reassignment in the controller rather than cabinet rewiring.

5.3 Uninterruptable Power Supply

An Uninterruptable Power Supply (UPS) may be used at intersections considered to be critical. Contact the GDOT District Traffic Operations Office and/or the maintaining agency to confirm need for a UPS.

UPS mounting configuration options include:

- Configuration 1: The UPS (Inverter/Charger, Bypass Switch, and Transfer Relay only) installed inside the cabinet, with the batteries installed in the externally mounted cabinet.
- Configuration 2: The entire UPS, including batteries, installed inside the externally mounted cabinet.
- Configuration 3: The entire UPS, including batteries, installed inside the traffic control device cabinet.

Technical specifications for UPS can be found in [Section 925](#) of the GDOT Specifications.

Application

- All intersections with railroad pre-emption
- Intersection of two multilane facilities
- Intersections with substandard sight distance

5.4 Power Disconnect

A power disconnect box shall be installed for each cabinet. The power disconnect should meet National Electrical Safety Code (NESC) and National Electrical Code (NEC) requirements. The disconnect box allows the power to be cut off in the event of equipment damage and/or live signal conductors on the ground. The location of the power service and meter base assembly should be identified on the signal plans.

For aerial power service feeds, the disconnect box should be located near the top of the signal pole that is adjacent to the controller cabinet. For underground power service feeds, the disconnect box should be located on a power pedestal near the signal cabinet. The designer should coordinate with the GDOT District Signal Engineer on the location preferences of disconnect boxes.

Refer to the traffic signal detail electric power service detail and see the traffic signal detail sheets for the current power disconnect schematic.

Chapter 6. Traffic Signal Communication - Contents

Chapter 6. Traffic Signal Communication - Contents.....6-i

6.1 Cellular Modems.....6-1

6.2 Fiber Optic Plant.....6-1

6.3 CAV Applications.....6-1

6.4 Quantities6-2

Chapter 6. Traffic Signal Communication

All GDOT traffic signals shall have IP communications back to a central server. Available communication devices include wireless transceivers, field switches, and cellular routers.

There are several possible communications scenarios available. The designer should consult with the District Traffic Operations Office to determine the appropriate communication medium.

6.1 Cellular Modems

Cellular modems are currently the default option for communications where GDOT does not have existing fiber optic facilities. Cellular communications can support additional cabinets and traffic surveillance cameras within a local area network. Supplemental connectivity to additional cabinets via fiber optics or other media is required. The GDOT Transportation Management Center (TMC) can provide a modem for any new signal build. If a modem will be used, include a callout at the cabinet to install modem provided by GDOT.

Application

- Intersections isolated from GDOT's fiber optic network
- Clustered intersections may use one modem supported by other local connectivity
- Supports any IP addressable device

6.2 Fiber Optic Plant

In areas within a reasonable range of the existing fiber optic network, GDOT may direct the designer to connect the new signal. As part of a larger roadway or corridor level traffic signal reconstruction project, GDOT may direct the designer to extend or install a fiber optic trunk extension.

When traffic signal improvements occur, all existing routers shall be returned to district forces.

For safety reasons, communications lines (low to no voltage) shall be placed in dedicated conduits separated from the traffic signal conductors and power service. The designer should account for this when calculating the necessary number of conduits

Fiber optic cables should be terminated in the cabinet in a fiber patch panel (FPP) or fiber distribution unit (FDU). An expanded discussion of fiber optic communication is available in the GDOT [ITS Design Guide](#).

Application

- Provides high bandwidth and speed where sufficient density of traffic signals, CCTV cameras, and other data collection devices exists
- Supports any IP addressable device

6.3 CAV Applications

Installation of connected vehicle infrastructure, such as vehicle-to-everything (V2X) devices, should be considered for all signalized intersections. GDOT will provide the roadside unit for installation on a project. The designers of an intersection with a roadside unit being installed should also provide for

a MAP file of the intersection. Contact the State Traffic Engineer for information regarding RSUs and MAP file creation.

The designer shall show on the plans the proposed Road Side Unit (RSU) using the appropriate cell and callout information. The RSU should be located on the pole in the same quadrant as the cabinet.

6.4 Quantities

Communication equipment is not included in the traffic signal lump sum pay item and shall be quantified separately in the equipment list. These items include, but are not limited to:

- 4G modems, if not provided by GDOT
- Fiber optic facilities
 - Trunk lines
 - Drop cables
 - Enclosures
 - FPPs, and FDUs
- Switches
- V2X devices

Chapter 7. Wiring Standards - Contents

- Chapter 7. Wiring Standards - Contents 7-i
 - 7.1 Signal Conductor Cable.....7-1
 - 7.2 Non-Signal Conductor Cabling7-2
 - 7.2.1 Shielded Three-Pair Lead-in Cable7-2
 - 7.2.2 Communications Cabling7-3
 - 7.2.3 Grounding Conductors and Electrodes7-3

Chapter 7. Wiring Standards

Wiring standards (installation and material) for signal faces, pedestrian heads, pedestrian pushbuttons, and loop detectors are defined in Section 937, Section 647 and Section 925 of the current [GDOT Standard Specifications](#).

7.1 Signal Conductor Cable

The number of signal conductors required for a signal span depends on the number and type of traffic signal faces. Table 7-1: Signal Conductor Cable Applications Outlines some common wiring scenarios.

Table 7-1: Signal Conductor Cable Applications

Number of Conductors	Usage of Conductors	Signal Face Configurations
Seven conductor cable	Single phase span including, but not limited to: <ul style="list-style-type: none"> • Three hot wires required, one neutral • Single pedestrian signal face two hot wires, one neutral 	
Seven conductor cable	Multi-phase spans or single-phase span with an overlap including, but not limited to: <ul style="list-style-type: none"> • Five to six hot wires required, one neutral. • Dual pedestrian signal faces four hot wires, one neutral. <p><u>Note: For converting a protected only or five-section protected/permmissive left-turn signal faces to four-section FYA signal faces, an additional seven conductor cable should be installed for the new signal face.</u></p>	
Two seven conductor cables	Multi-phase spans with four-section FYA left-turn signal faces. Use one seven conductor cable per phase or overlap.	

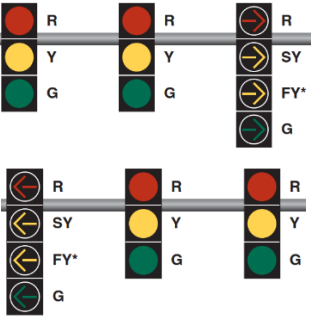
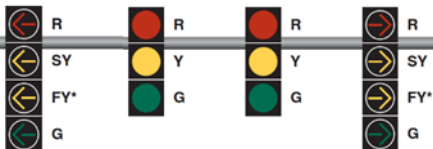
Number of Conductors	Usage of Conductors	Signal Face Configurations
	Six to seven hot wires required, one neutral	
Three seven conductor cables	Multi-phase spans with four-section FYA left-turn and right turn overlap signal faces. Use one seven conductor cable per phase or overlap. Three to four hot wires required, one neutral	

7.2 Non-Signal Conductor Cabling

This section discusses the types and applications of other types of cabling required for vehicle detection and communications.

7.2.1 Shielded Three-Pair Lead-in Cable

Detector loops are spliced to a shielded three-pair lead-in cable in a pull box placed within 10 feet of the edge of pavement. Loop leads cut from the loop to the edge of pavement should not exceed 75 feet. Loop leads in pavement should be as short as possible. The shielded lead-in cable should be splice free from the farthest pull box to the cabinet termination.

One (1) three-pair lead-in cable can be used for up to three loops. Each phase must have a separate loop lead cable(s). As an example, a three-pair shielded cable shall not be used for both Phases 2 and 5. If present, each phase is required to have a mutually exclusive three-pair shielded cables, although not all cable pairs may be used.

Application

- Inductance loop leads from roadside to cabinet
- Pedestrian push button connections to cabinet

Design Consideration

- Loop leads are required to be unique per each phase. For example, phases 2 and 5 must have exclusive loop lead cables to the cabinet even if all three pairs are not used for either phase (i.e. phase 2 has two loops and phase five has one).

7.2.2 Communications Cabling

The designer should be familiar with the cabling requirements of detection systems that use proprietary cabling to combine power and/or video/data. These items may be needed for the materials lists. Please refer to the traffic signal specifications, [Section 937](#) and [Section 647](#) for material, installation and contractor payment information.

7.2.3 Grounding Conductors and Electrodes

- Ground the controller cabinet assemblies, controller, poles, pull boxes, and conduit to reduce extraneous voltage to protect personnel or equipment.
- Ground all span wire and down guy assemblies as shown on Standard Detail Drawings. Bind all span wire together and secure to ground at every pole.
- Join the grounding electrodes and connect them to the grounding buss of the controller cabinet assembly with No. 6 AWG solid copper wire.
- Use the shortest possible ground lead to the grounding source.
- All components, including mounting hardware, shall be grounded and bonded per manufacturer's recommendations and NEC. Dress and route grounding wires separately from all other controller cabinet assembly wiring.
- Install grounding electrodes of size, length and material specified in Section 682.
- Ground any pole-mounted equipment to the pole, except 336 controller cabinet assemblies and power service if pole mounted.
- Install grounding electrodes adjacent to the traffic signal pole bases, preformed controller cabinet assembly bases, and in pull boxes to protect the grounding system.
- Install a minimum of 3 grounding electrodes for each pole, pedestal, and the controller cabinet assembly.
- Grounding electrode stacking may be permitted in areas where ground conditions allow.

Intentionally Left Blank

Chapter 8. Conduit and Pull Boxes - Contents

Chapter 8. Conduit and Pull Boxes - Contents8-i

8.1 Conduit Calculations.....8-1

8.2 Pull Boxes.....8-3

8.3 Trenching and Boring8-5

Chapter 8. Conduit and Pull Boxes

The cabinet, signal poles, and pedestrian poles should have separate pull boxes. The placements of cable, conduit, and pull boxes shall be in accordance with [Section 647](#) of the current GDOT Standard Specifications. Conduits shall be routed to a pull box adjacent to the cabinet and then routed into the cabinet base.

A spare conduit is not required at every bore. Conduit for loop lead-ins should not contain runs over 100 feet between pull boxes unless a shorter distance is specified by district. For conduit distances of 20 feet or less, Type 2 conduit (PVC) should be used. Type 3, high-density polyethylene (HDPE), should be used when boring conduit.

In general, all conduits shall be a minimum of two (2) inches in diameter except for the power service, which should be one (1) inch galvanized rigid steel conduit.

Communications equipment should be in its own pull box when feasible. A power service shall be installed in separate pull boxes and conduits. Signal cables should be installed in separate conduits, but they can be run into the same pull box used for loop cables. Loop lead-ins, pedestrian pushbutton cables, and communication cables may be installed in the same conduit; however, it is preferred to isolate communications cable from loop lead-in and pedestrian pushbutton cables.

Table 8-1: Conduit Type and Application

Galvanized Rigid Steel (GRS)	Power Service (1 inch) All above ground (exposed) conduit
Type 2 (PVC)	Short run sections (approximately 20 feet or less) Elbows into pole bases, cabinet assemblies and pull boxes
Type 3 (HDPE)	Trench sections greater than 20 feet Directional boring Direct pull box to pull box connections

8.1 Conduit Calculations

Per the National Electrical Code, conduits should not be filled more than 40 percent of their cross-sectional area. To determine number of conduits, the designer shall first identify the number of unique cables along a cut trench or underground bore. **Table 8-2** identifies cables that are required to be isolated for each other in separate conduits.

Table 8-2: Minimum Conduit Requirements for Separating Cabling

Communications (Fiber Optic Cable – No Voltage)	Dedicated 2-inch conduit
Signal Conductors (120 Volts)	Dedicated 2-inch conduit
Vehicle Detection System Leads Pedestrian Push Buttons	Dedicated 2-inch conduit
Power Feed	Dedicated 1-inch conduit
Spare for Future Use	Dedicated 2-inch conduit

Table 8-3 below presents the available cross-sectional areas of conduits as well as the cross-sectional area occupied by a variety of cables. The designer should calculate the percentage fill of each conduit to verify that additional conduits are not required. For practical purposes, the conduits most likely to exceed the 40 percent fill (which require additional conduits) are those used for signal conductors.

Table 8-3: : Cross-Sectional Areas of Conduits and Cabling

Conduit Cross Section Area				
Nominal Diameter, in.	1	2	3	4
Inside Diameter, in.	1.049	2.067	3.068	4.026
Inside Area, sq. in.	0.86	3.36	7.38	12.72

Specification or Material	Cable Use	No. of Conductors AWG	Cross Section Area, sq. in.
IMSA 19-1 or 20-1	Signals	2/C # 14	0.08
		3/C # 14	0.09
		4/C # 14	0.11
		5/C # 14	0.13
		7/C # 14	0.15
IMSA 50-2	3-pair Shielded Loop Lead	# 18	0.17
RG-59/U	Coax Camera Cable	# 20	0.04
NESC Heavy/Medium/Light	6-Fiber Drop Cable	n/a	0.05
NESC Heavy/Medium/Light	12-Fiber Drop Cable	n/a	0.07
ANSI/ICEA S-87-640	48 Fiber Trunk Cable	n/a	0.13

ANSI/ICEA S-87-641	72 Fiber Trunk Cable	n/a	0.13
ANSI/ICEA S-87-642	144 Fiber Cable	n/a	0.30
6C Lead Cable	Radar Detector	6/C # 20	0.14
RG-6/V (COAX)	Video Detector	1/C # 18	0.06
RG-6/V With Power (COAX)	Video Detector	1/C # 18 (COAX) 2/C # 16 (Power)	0.16
RG-8/U (COAX)	Radio Antenna	1/C # 11	0.13
Ethernet Cat 6e Armored	Communications	8/C # 24	0.13

8.2 Pull Boxes

Pull boxes provide in-ground access to wiring at intersections of conduits. They are used at regular intervals to provide access to wiring, which feeds various parts of traffic signal infrastructure. A detailed explanation of the appropriate use of each type of pull box, along with sizes and placement specifications, can be found in **Table 8-4**. Contact the GDOT District Traffic Operations Office for preferences on pull box types.

Table 8-4: Pull Box Types and Applications

Type 1	<p>Nominal size 12 x 12 inches and 12 inches deep</p> <ul style="list-style-type: none"> Limited uses due to small size Power service wire Used for loop lead splices to loop wire at roadside Used for luminaire conductors attached to signal poles
Type 2	<p>Nominal size 18 x 12 inches and 12 inches deep</p> <ul style="list-style-type: none"> Most commonly used pull box for regular in-line pulling or bending points in long conduit runs for loop leads Recommended for pedestrian pedestals Can be used at strain pole locations with up to six (6) intersecting conduits Consider the type and number of conductors that will pass through the pull box. Type 2 boxes do not have sufficient volume to store slack cable for more than four (4) conductors.
Type 3	<p>Nominal size 30 x 18 inches and 12 inches deep</p> <ul style="list-style-type: none"> Commonly used at intersection quadrants near strain poles where conduits intersect from more than two directions Recommended for intersections of six (6) to ten (10) conduits
Type 4 & 4S	<p>Nominal size 36 x 24 inches (36 inches deep – “4S” (shallow) 18 inches deep)</p> <ul style="list-style-type: none"> Use as signal conductor distribution point near the traffic signal cabinet

	<ul style="list-style-type: none"> • Supports ten (10) or more conduits and cable slack for an entire intersection • 4S model can be used for shallow depth in urban and suburban areas with congested underground utilities • May be used for fiber optic drop cable splice in areas with congested underground utilities
Types 5 through 7 for use with network communications (fiber optic cable)	
Type 5 & 5S	<p>Nominal size 48 x 30 inches (36 inches deep – “5S” (shallow) 18 inches deep)</p> <ul style="list-style-type: none"> • For splicing fiber optic drop cable at intersection • 5S model can be used for shallow depth in urban and suburban areas where number of and depth of utilities is a concern
Type 6	<p>Nominal size 36 x 24 inches and 36 inches deep</p> <ul style="list-style-type: none"> • Contains rack mounting system for storage of maintenance coil per the ITS Design Guidelines • Use Type 6 pull boxes for nodes and along the conduit line
Type 7	<p>Nominal size 48 x 30 inches and 36 inches deep</p> <ul style="list-style-type: none"> • Contains rack mounting system for splice enclosure and storage of maintenance coil per the ITS Design Guidelines\ • Use Type 7 when splicing trunk lines together

Application

- In-ground access to wiring near infrastructure such as cabinets, strain poles and pedestals
- Distribution point of intersection wiring to/from multiple directions within conduit network
- Spaced at regular intervals on long linear runs for installing cable and/or significant bending points in the conduit line.

Design Consideration

- For long conduit runs for setback loops or communications between intersections, provide pull boxes at regular intervals.
- Consider number and size of intersecting conduits when specifying pull box size.
- Desired spacing for network communications can be found in the ITS Design Guidelines.
- Do not place pull boxes on the curb side of the signal pole in the intersection radius return.
- Orient pull boxes with the longest dimension parallel to the roadway.
- The distance between pull boxes in a run of conduit shall not be greater than 100 ft (30 m), except for fiber optic cable.
- Conduit entrance shall be through the open bottom in Types 1, 2, 3, 4S, and 5S.
- Conduit entrance shall be directly through cored holes in the side walls in Types 4 and 5.

- Conduit entrance shall be through the conduit terminators in Types 6 and 7.
- Where conduit entrance shall be through the side wall in Types 4 and 5, or for conduit other than the terminator size provided in Types 6 and 7, use field cored conduit entrance holes in the side wall of the box.
- Install the pull box at a location that is level with the surrounding ground or pavement. Do not place a pull box in a ditch or depression. When installed either in a sidewalk or in the ground, the top of the pull box shall be level with the sidewalk or ground surface.
- Metal lids or covers shall be properly grounded.

8.3 Trenching and Boring

Conduits should be trenched unless the conduit is to be placed under pavement or in environmentally sensitive areas. All conduit installation requiring boring will use Type 3 HDPE boring conduit. The size of directional bore being used, the number of conduits, and the length of the bore should be identified on the plans as shown in Table 2-1: Legend Items of Traffic Signals.

Intentionally Left Blank

Chapter 9. Traffic Signal Related Signs - Contents

Chapter 9. Traffic Signal Related Signs - Contents9-i

9.1 Regulatory Signs9-1

9.2 Guide Signs9-2

Chapter 9. Traffic Signal Related Signs

Traffic signs should be specified and mounted according to the [MUTCD](#) and GDOT [Signing and Marking Design Guidelines](#). Generally, only those signs located within the intersection footprint or physically attached to the traffic signal infrastructure should be included in the Series 27 plans.

All post-mounted signs should be paid for under signing and marking pay items and placed on the signing and marking plan sheets. For signal upgrade projects where signing and marking plan sheets are not included, all proposed signs should be paid for under the signal installation upgrade pay items and placed on the signal design plan sheet(s).

Two types of signs are discussed in this section: regulatory and guide signs.

9.1 Regulatory Signs

Regulatory signs may be post-mounted, placed on a mast arm, or hung on a span wire. All regulatory signs placed on a mast arm or hung on a span wire should be shown on the signal design plan sheet. MicroStation sign cells should be shown and labeled at the installation location and summarized on the same plan sheet under the heading “Regulatory Signs” (see A-2 in *Appendix A: Traffic Signal Plan Examples*). To minimize clutter on the mast arm or span wire, the following list can serve as a guideline for situations that may warrant the installation of overhead regulatory signing in lieu of a post-mounted sign. Each occurrence should be properly studied and GDOT approved before a final determination is made.

- Three or more traffic lanes in each direction
- Restricted sight distance
- Complex intersection and/or signalization design
- Multi-lane turns
- Insufficient space for ground signs
- Change in basic cross section (i.e. Dropping through lane as a turn-only lane)

Typical post-mounted signs that appear on a signal design plan sheet (for permitting purposes) are the R560-5 signs (STATE LAW STOP FOR PEDESTRIANS IN CROSSWALK) and [R1-2](#) signs (YIELD). Variations of these signs should be used at all signalized locations that have a free-flowing or yield-controlled right-turn channelized lane. [R1-2](#) signs should also be installed at all right-turn lanes separated by a physical concrete island that do not have a dedicated receiving lane. At locations without physical islands, a stop bar should be extended across the right-turn lane and a [R1-2](#) sign shall not be installed. Other post-mounted regulatory signs that affect signal operations (such as no U-turn) may be shown on the signal plans for informational purposes and permitting.

Intersections designed for railroad pre-emption may require signs or signal faces which restrict specific movements when a train is present at the intersection. When a right turn is restricted during pre-emption the blank-out version of the R3-1 sign, as shown in **Figure 9-1**, should be installed at the intersection. When a left turn is restricted during pre-emption, a left-turn signal face should be installed and programmed to show a solid red arrow during the pre-emption sequence. A blank-out version of

the [R3-2](#) sign may be installed in lieu of a left-turn signal face, but this is not the preferred option. See Section 2.8 for more information on traffic signal pre-emption.

All blank-out signs should be shown on the signal design plan sheet. Sign cells should be shown and labeled at the installation location and summarized on the same plan sheet under the heading “Blank-out Signs.” Blank-out signs should be centered over the turn lane(s) they control; one 24-inch x 24-inch blank-out sign should be installed for single turn lanes and one 36-inch x 36-

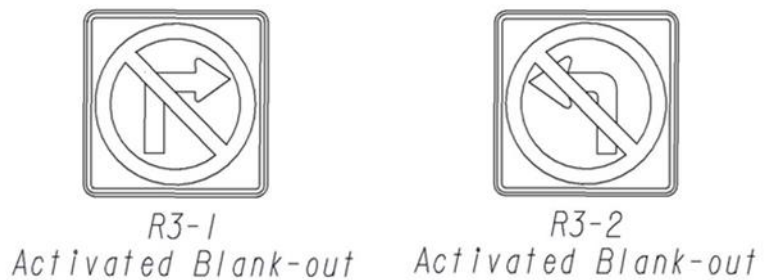

Figure 9-1: Blank-Out Sign Displays

inch blank-out sign for multilane configurations. Note: Pictorial version for blank-out signs is preferred.

9.2 Guide Signs

Overhead street name signs should be mounted on the overhead signal support structure parallel to the street it identifies. The sign should be mounted between the two (through movement) signal faces associated with phases 2, 4, 6, and/or 8. The preferred spacing between the signs and the signal backplate is 1-foot spacing with a minimum of 6 inches. Longer street names can create conflicts with proper placement of the traffic signal faces. In this case the overhead street name sign may be attached to the strain pole and cantilevered toward the intersection.

Two-sided overhead street name signs are permitted.

Illuminated overhead street name signs are allowed but not included under GDOT standard installation. Local jurisdictions are required to cover the associated expenses. If the width of the illuminated sign cannot be accommodated between the two signal faces, the D3-1 sign should be placed to the right of the signal faces, on the strain pole, or mast arm pole. The cell of any overhead street name sign that is used within a drawing should be placed under a heading “Overhead Street Name Signs” on a plan sheet.

Overhead street name signs should only include the name of the roadway. For overhead street name signs at interstate ramps, the sign should include the interstate name, direction, and a directional arrow (e.g., I-75 South →) for one-way facilities. Directional arrows may also be used when the approaching roadway has two different names for the street turning right and left.

State and US Route numbers may be used on the D3-1 signs when no common street name is available.

D3-1 and D3-1a signs should use D series letters. Section 3.6 of the GDOT [Signing and Marking Design Guidelines](#) provides further guidance on the dimensions and layout of the overhead street name signs.

Other guide signs such as State Routes, US Highway and interstate shields, and distance and destination signs should be included on the signs and markings plan sheets.

Chapter 10. Vehicle Detection - Contents

- Chapter 10. Vehicle Detection - Contents..... 10-i
 - 10.1 Methods of Detection.....10-1
 - 10.1.1 Inductive Loop Detectors.....10-1
 - 10.1.2 Microwave/Radar Detection10-3
 - 10.1.3 Wireless Magnetometer Detection10-4
 - 10.1.4 Intersection Video Detection Systems (IVDS).....10-5
 - 10.2 Detector Size, Shape and Placement.....10-6

Chapter 10. Vehicle Detection

Traffic signal phases are actuated through some means of vehicle detection. Whether detecting stopped traffic at the stop bar or approaching traffic, the selection of vehicle detection equipment and placement is essential for the intended operation of the traffic signal. Vehicle detection is used for multiple traffic signal functions, including:

- Activation and/or extension of signal phases
- Stop bar detection for left-turn lanes and minor street approaches
- Setback detection on major streets for approaching traffic
- Data collection
- Intersection traffic counts
- ATSPM
- Traffic responsive or adaptive operation
- Queue detection

10.1 Methods of Detection

[Section 937](#) of the current GDOT Standard Specifications provides details regarding the various forms of vehicle detection available for signalized intersections.

Multiple technologies are available for use:

- Inductance loops (default method for in pavement detection method)
- Microwave / radar (default method for noninvasive detection method)
- Wireless magnetometer (in pavement detection method)
- Video detection (noninvasive detection method)

Each vehicle detection technology has advantages and disadvantages. The designer should be familiar with these systems to select the detection methodology that best fits the project.

10.1.1 Inductive Loop Detectors

Inductive Loop Detection System: a rack-mounted card inserted into the cabinet input file that supplies an electric current to a coil of wire embedded in the travel lane, which measures changes in the inductance (magnetic field) when vehicles pass over the coil of wire. There are two type of inductive loop system:

- Type A: a rack-mounted inductance loop detector card that sends a contact closure to the controller.
- Type B: an IP addressable rack-mounted vehicle detector card.

The default vehicle detection option is inductive loop detectors. Inductive loop detectors are coils of wire sealed in saw cuts made in the roadway surface. Inductive loop detectors are generally reliable

and accurate; however, they require a high degree of maintenance relative to other available detection technologies.

It is recommended that the loop leads are drawn out of the rear (upstream position) of the loop. In the case of stop bar detection, pavement rutting that can stretch and break loop leads is more likely to occur at the stop bar. Cutting the loop leads in this fashion is also beneficial for setback loops as well. When setback loop failure occurs, the loops can be reinstalled directly behind the original location and utilize the same saw slot. This is illustrated in **Figure 10-1**.

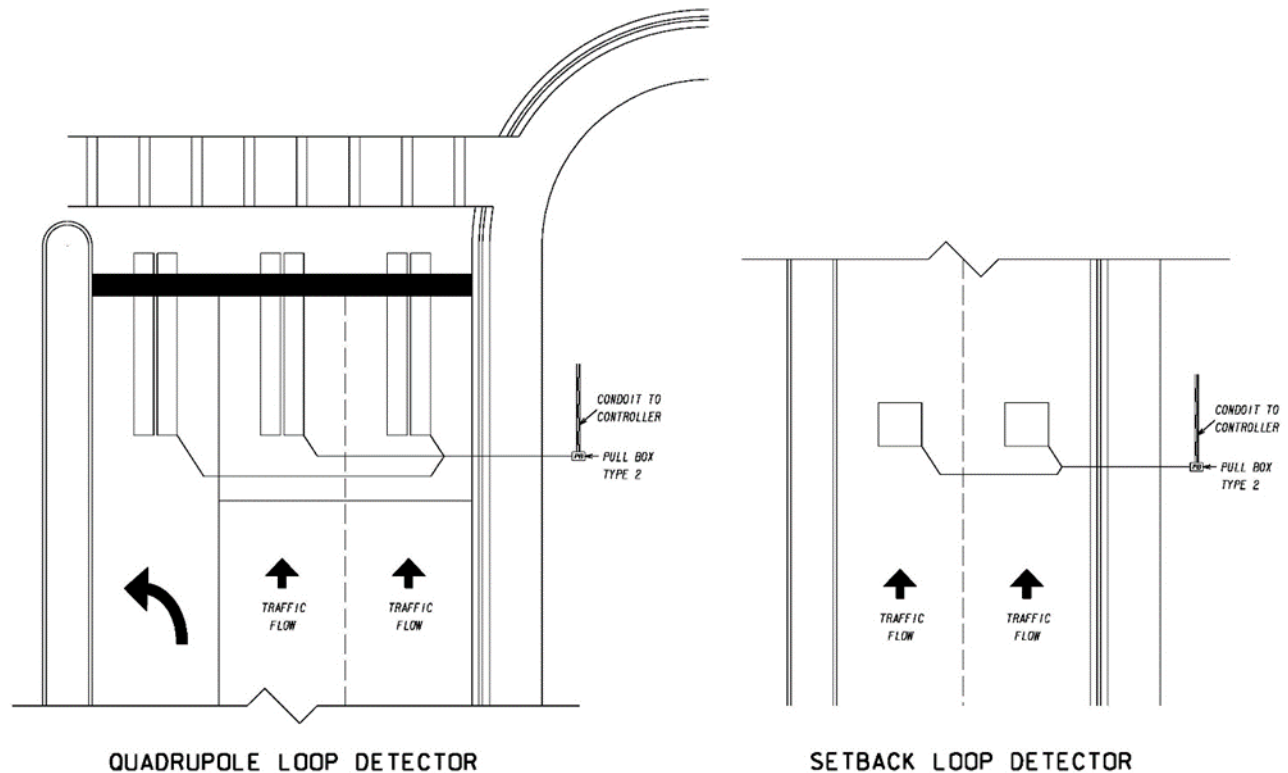

Figure 10-1: Loop Detector Lead Location

Application

- Stop bar or advanced detection (size and shape dependent).
- Traffic signal data collection (traffic volumes and occupancy).

Design Consideration

- Long quadrupole loops at the stop bar do not provide accurate data for vehicle counting or ATSPM.
- The pavement should be in good condition. The installation of inductive loops in cracked, rutted, or patched pavement is not recommended.
- Cannot be used in reinforced concrete slabs such as bridge decks or bridge approach slabs.

- Avoid installing around manhole lids and areas with multiple utility valves in the detection zones. Large metal objects can affect detection and these areas can be excavated by utility companies at any time.
- Provide connectivity to cabinet for setback detectors. Must have or be able to construct a continuous path from farthest pull box to cabinet. This may be difficult in urban environments.

Additional Considerations

- Inductive loops are the default choice of vehicle detection by GDOT, unless GDOT chooses to consider a non-invasive detection technology.
- Check resurfacing program to determine if roadway to be resurfaced in the near future. If so, noninvasive detection system should be considered.
- Consider noninvasive system if inductance loops have been repeatedly replaced in the same location. Successive saw cuts in the same location can shorten pavement life and lead to additional loop failures.

10.1.2 Microwave/Radar Detection

Microwave/radar vehicle detection is typically more expensive initially than inductive loops but requires less long-term maintenance. There are multiple manufacturers of microwave/radar-based vehicle detection systems. These systems are not embedded in the roadway surface; they consist of:

- Fixed mounted emitter units
- In cabinet interface equipment

The detector units are programmed to scan virtual detection zones. These virtual detection zones should emulate the same size, shape, location, and mode of an inductance loop.

These installations include multiple components; the designer should be familiar with these systems and include all required items in the quantities. Refer to current GDOT Standard Specifications Section 937.3.05 for additional details on requirements and installation.

Application

- Stop bar or advanced detection.
- Traffic signal data collection.
- Non-invasive detection system.
- Not affected by resurfacing pavement. Detection zones are flexible making this a preferred detection method for construction projects involving shifting lanes at intersections for maintenance of traffic.

Design Consideration

- Requires rigid attachments on traffic signal poles and mast arms. See *Appendix A: Traffic Signal Plan Examples*, page A-4, for example.
- Provides volume and ATSPM data, however data accuracy can be diminished in downtown areas (i.e. high building density close to roadway) and very high pedestrian activity (i.e. convention centers, arenas, stadiums, colleges, etc.)

- Placement of detection unit per manufacturer's recommendations to achieve optimal operation. Extension arms may be attached to strain poles to better position detection unit.

Additional Considerations

- Generally, requires minimal maintenance. Consult with district or local maintaining agency regarding preference of these devices.

10.1.3 Wireless Magnetometer Detection

Magnetometer vehicle detectors are small, wireless sensors embedded in the road surface. This method of detection consists of multiple components including:

- Vehicle sensors (multiple sensors required in series to replicate 6 x 40 inductance loops)
- Radio receivers/repeaters
- Access point (master radio)
- In cabinet interface equipment

Care should be given to placement of the access point(s) and wireless repeater(s).

These installations include multiple components. The designer should be familiar with these systems and include all required items in the quantities. There are two types of wireless magnetometer detection systems, Type A and Type B. Type B should be used for presence actuation only, Type A should be used for all other detection applications. Refer to current [GDOT Standard Specifications](#) Section 937.3.06 for additional details on requirements and installation.

At least one digital radio access point, typically installed on the pole closest to the cabinet, is required per intersection and has the capability of detecting magnetometers within line of sight and a 100-150 feet foot range. Wireless repeaters, installed on poles away from the cabinet, may be required to relay data from magnetometers to the access point. Wireless repeaters should be called out on a plan sheet to provide proper communications to all units. The orientation of the wireless repeater should also be indicated on a plan sheet. Each installation requires appropriate cabling to connect the access point to the cabinet's interface equipment.

Application

- Stop bar or advanced detection.
- Traffic signal data collection.

Design Consideration

- In pavement detectors with limit radio range. Radio repeaters may be necessary.
- Radios require rigid attachments on traffic signal poles and mast arms.
- All radios limited to line of sight transmission and reception.
- Placement of detection unit per manufacturer's recommendations to achieve optimal operation. Extension arms may be attached to strain poles to better position detection unit.

Additional Considerations

- Generally, requires minimal maintenance. Battery life can last years. Consult with district or local maintaining agency regarding preference and staff capabilities with these devices.
- Typical installation may require removal for roadway resurfacing. Not recommended for roadways due for resurfacing.

10.1.4 Intersection Video Detection Systems (IVDS)

Video detection systems (IVDS) consist of rigidly mounted cameras and programmed virtual detection zones. There are two types of Video Detection Systems, Type A and Type B. Refer to current [GDOT Standard Specification](#) section 937.2.04 for additional details on requirements and installation.

IVDS assemblies include multiple components; care should be taken in determining the necessary components and their locations. The installed location of cameras is critical to the design of an IVDS system.

Typically, cameras are located on the side of the intersection farthest from the programmed detection zone. If mast arms are present, cameras should be mounted directly over receiving lanes at the proper mounting height. If mast arms are not present, cameras should be placed as to provide the clearest head-on view of the vehicles in the approach lane. All existing and proposed cameras should be called out on a plan sheet. The direction of the camera should be indicated on the plan sheet.

Application

- Stop bar or advanced detection.
- Traffic signal data collection.
- Noninvasive detection system.
- Not affected by resurfacing pavement. Detection zones are flexible making this an acceptable method of method for construction projects involving shifting lanes at intersections for maintenance of traffic. See additional considerations below.

Design Consideration

- Least preferred method by GDOT. Some local maintaining agencies still prefer this type of detection. The designer should confirm type of detection with appropriate stakeholders at the start of the project.
- For best results regarding setback loops, the camera should be setback as well.
- Requires rigid attachments on traffic signal poles and mast arms.
- Location and sight lines of cameras critical to proper detection of vehicles. Consult manufacturer's recommendations for camera placement.
- Attach cameras to extension arms on strain poles or on mast arms for better camera placement.

Additional Considerations



- Consult with district or local maintaining agency regarding preference with these devices.

- These units can frequently be affected by adverse weather and/or street lighting conditions. They should be avoided in areas susceptible to sun glare (consider seasonal movement of sun), fog and snow.
- In urban areas a combination of wet pavement and reflection of fixed light sources, such as streetlights or parking lots, can cause false signal actuations.

10.2 Detector Size, Shape and Placement

The same type of detection system should be used on all approaches of an intersection.

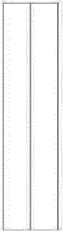
Table 10-1: Inductance Loop Size, Shape and Application

<p>6 by 40-foot quadrupole loop or equivalent</p> 	<p>Application: Stop bar application for detecting stopped traffic in left-turn lanes and minor street approaches (non-coordinated or non-recall phases). Noninvasive detection systems should be setup to emulate the same size and location of detection area.</p> <p>More sensitive for tall vehicles such as semi-truck trailers and school busses. Also, better for detecting motorcycles, which have a relatively low mass of metal compared to a passenger vehicle.</p> <p>Detection Mode: Loop detectors or virtual detection zones shall be set for “presence” mode. A contact closure is sent to the traffic signal controller for the full duration of a vehicle(s) being present on the detector.</p> <p>Quantities: 344 feet of loop wire plus two times the loop lead distance to the first pull box and 132 feet of saw cut, plus the distance to the curb or edge of pavement. Loop lead wire to the cabinet is a separate item.</p>
<p>6 by 6-foot square loop or equivalent</p> 	<p>Application: Setback detector with distance is variable based upon approach speeds. Combination of distance and phase passage time set in controller designed to reduce/eliminate the driver’s dilemma zone. Noninvasive detection systems should be setup to emulate the same size and location of detection area.</p> <p>Detection Mode: Loop detectors or virtual detection zones shall be set for “pulse: mode. A momentary contact closure is sent to the traffic signal controller when a vehicle is detected. This resets the gap timer for the active phase and recorded by the traffic signal controller for data analytics such as ATSPM.</p> <p>Quantities: 72 feet of loop wire plus two times the loop lead distance to the first pull box and 24 feet of saw cut, plus the distance to the curb or edge of pavement. Loop lead wire to the cabinet is a separate item.</p>

If the minor street serves similar traffic volumes or has a design speed exceeding 35 mph, setback detectors should also be installed on these approaches. All setback passage detectors should be shown as a six-foot by six-foot square zone with a label specifying the distance from the front of the detection zone to the stop bar.

Table 10-2 presents the desired distance from the stop bar to the setback detector for different design speeds. Setback detectors are important to reduce or eliminate the dilemma zone. The use of setback detectors enhances safety at signalized intersections by reducing the number of drivers that may have difficulty deciding whether to stop or proceed during a yellow change interval. This reduces rear-end crashes associated with unsafe stopping and angle crashes due to red light running. If setback

passage detectors cannot be placed at the exact recommended distance due to an obstruction, they should be placed farther from rather than closer to the stop bar.

Table 10-2: Setback Detector Distance

Posted Speed Limit (miles per hour)	Minimum Setback Distance (feet)
35	260
40	300
45	330
50	370
55	410
60	440
65	480

Source: GDOT Policy 6785-1

Atypical detection locations may be installed to provide additional signal timing benefits. Additional may be installed for the mainline through phases to facilitate automated turning movement counts, performance metrics, adaptive signal timing, and other beneficial signal timing features. Setback detection may be installed for the side street for intersections with high vehicle speeds, dual coordination, heavy traffic volumes, etc.

Intentionally Left Blank

Chapter 11. References - Contents

Chapter 11. References - Contents 11-i

Chapter 11. References

- AASHTO. 2011. *Roadside Design Guide*. American Association of State Highway and Transportation Officials. <https://store.transportation.org/Item/CollectionDetail?ID=105>.
- AASHTO. 2013. *Standard Specifications for Structural Supports for Highway Signs, Luminaires, and Traffic Signals*. Sixth Edition, with 2015, 2019, 2020 and 2022 Interim Revisions. American Association of State Highway and Transportation Officials. <https://store.transportation.org/Item/CollectionDetail?ID=126>
- AASHTO. 2018. *A Policy on Geometric Design of Highways and Streets*. Green Book. American Association of State Highway and Transportation Officials. <https://store.transportation.org/Item/CollectionDetail/180?NoCategory>.
- FHWA. 2006. *Traffic Detector Handbook: Third Edition—Volume I*. Publication No. FHWA-HRT-06-108. U.S. Department of Transportation, Federal Highway Administration. October 2006. <https://www.fhwa.dot.gov/publications/research/operations/its/06108/06108.pdf>.
- FHWA. 2006. *Traffic Detector Handbook: Third Edition—Volume II*. Publication No. FHWA-HRT-06-139. U.S. Department of Transportation, Federal Highway Administration. October 2006. <https://www.fhwa.dot.gov/publications/research/operations/its/06139/06139.pdf>.
- FHWA. 2009. *Manual on Uniform Traffic Control Devices for Streets and Highways*. Federal Highway Administration. December 2009. https://mutcd.fhwa.dot.gov/pdfs/2009r1r2/pdf_index.htm.
- FHWA. 2012. *Standard Highway Signs: Including Pavement Markings and Standard Alphabets*. 2012 Supplement. U.S. Department of Transportation, Federal Highway Administration. https://mutcd.fhwa.dot.gov/SHSe/shs_2004_2012_sup.pdf.
- FHWA. 2013. *Work Zone Operations Best Practices Guidebook*. Third Edition Report No. FHWA-HOP-13-012. 2013. <https://ops.fhwa.dot.gov/wz/practices/best/documents/bpguidebook.pdf>.
- FHWA. 2018. *Interim Approval 21 – Rectangular Rapid-Flashing Beacons at Crosswalks*. U.S. Department of Transportation, Federal Highway Administration. https://mutcd.fhwa.dot.gov/resources/interim_approval/ia21/index.htm.
- FHWA. 2019. *Railroad-Highway Grade Crossing Handbook*. Revised Third Edition. U.S. Department of Transportation, Federal Highway Administration. July 2019 https://safety.fhwa.dot.gov/hsip/xings/com_roaduser/fhwasa18040/fhwasa18040v2.pdf.
- GDOT Construction Detail A-3. http://mydocs.dot.ga.gov/info/gdotpubs/ConstructionStandardsAndDetails/A-3_A-3.pdf.
- GDOT Construction Detail A-4. <http://mydocs.dot.ga.gov/info/gdotpubs/ConstructionStandardsAndDetails/A-4.pdf>.
- GDOT. 2013. *Electronic Data Guidelines*. Version 4.1.6. Georgia Department of Transportation. July 2013. http://www.dot.ga.gov/PartnerSmart/DesignManuals/ElectronicData/Electronic_Data_Guidelines.pdf.

- GDOT. 2016. *Utility Accommodation Policy and Standards*.
http://www.dot.ga.gov/PartnerSmart/utilities/Documents/2016_UAM.pdf.
- GDOT. 2017. *Plan Development Process*. Georgia Department of Transportation. September 2017.
<http://www.dot.ga.gov/PartnerSmart/DesignManuals/PDP/PDP.pdf>.
- GDOT. 2017. *Plan Presentation Guide*. Georgia Department of Transportation. July 2017.
http://www.dot.ga.gov/PartnerSmart/DesignManuals/Plan/Plan_Presentation_Guide.pdf.
- GDOT. 2017. *Policy 6785-2: Left Turn Phasing*. Georgia Department of Transportation.
<http://mydocs.dot.ga.gov/info/gdotpubs/Publications/6785-2.pdf>.
- GDOT. 2018. *Design Policy Manual*. Georgia Department of Transportation. April 2018.
<http://www.dot.ga.gov/PartnerSmart/DesignManuals/DesignPolicy/GDOT-DPM.pdf>.
- GDOT. 2018. *Pedestrian and Streetscape Guide*. Georgia Department of Transportation. August 2018.
<http://www.dot.ga.gov/PartnerSmart/DesignManuals/TrafficOps/GDOT%20Pedestrian%20and%20Streetscape%20Guide.pdf>.
- GDOT. 2020. *ITS Design Manual*. Georgia Department of Transportation. November 2020.
<http://www.dot.ga.gov/PartnerSmart/DesignManuals/TrafficOps/ITSDesignManual.pdf>.
- GDOT. 2020. Policy 6785-1: Traffic Signals. Georgia Department of Transportation.
<http://mygdot.dot.ga.gov/applications/gdotpubs/Publications/6785-1.pdf>
- GDOT. 2021. *Signing and Marking Design Guidelines*. Georgia Department of Transportation. August 2021.
<http://www.dot.ga.gov/PartnerSmart/DesignManuals/smguide/GDOT%20SIGNING%20AND%20MARKING%20DESIGN%20GUIDELINES.pdf>.
- GDOT. 2021. *Standard Specifications: Construction of Transportation Systems*. Georgia Department of Transportation.
<http://www.dot.ga.gov/PartnerSmart/Business/Source/specs/2021StandardSpecifications.pdf>.
- ITE. 1991. *Manual of Traffic Signal Design*. Second Edition. Institute of Transportation Engineers.
<https://trid.trb.org/view/349378>.
- Transportation Electrical Equipment Specifications, current edition and addenda. These specifications are referenced by GDOT's Traffic Signal Equipment specifications.

Appendix A. Traffic Signal Plan Examples

Index of Plans:

A-2: Franklin Boulevard @ Smith Street.

Example of full four-way, 8 vehicle phase and 4 ped phase intersection with Dual Left Turn, Right Turn Overlap, Protected/Permissive Right Turn, and FYA Right and Left Turn.

A-3: Benjamin Road @ Aaron Street/Brooks Boulevard.

Example of full four-way 8 vehicle phase and 4 ped phase intersection with FYA Left Turn.

A-4: Dadesville Rd @ Red Fern Rd.

Example of Split Phasing.

A-5: SR 20 @ Oak Grove Road.

Example of Split Phasing.

A-6: SR 5/SR 8/US 278/Veterans Memorial Hwy @ Powder Springs Rd.

Example of Rail Road Pre-emption.

A-7: Cliff Boulevard @ Briar Drive/St Louis Rd Midblock Crossing.

Example of midblock crossing using pedestrian hybrid beacon.

A-8: Gingerbread Road @ Georgia Parkway/Dynamic Parkway.

Example of using wireless sensor for detection.

NOTE:

These traffic signal plan examples are approved before recent (2021) Traffic Signal and ITS Specifications updates, therefore they do not reflect the impacts of the traffic signal and ITS specification updates.

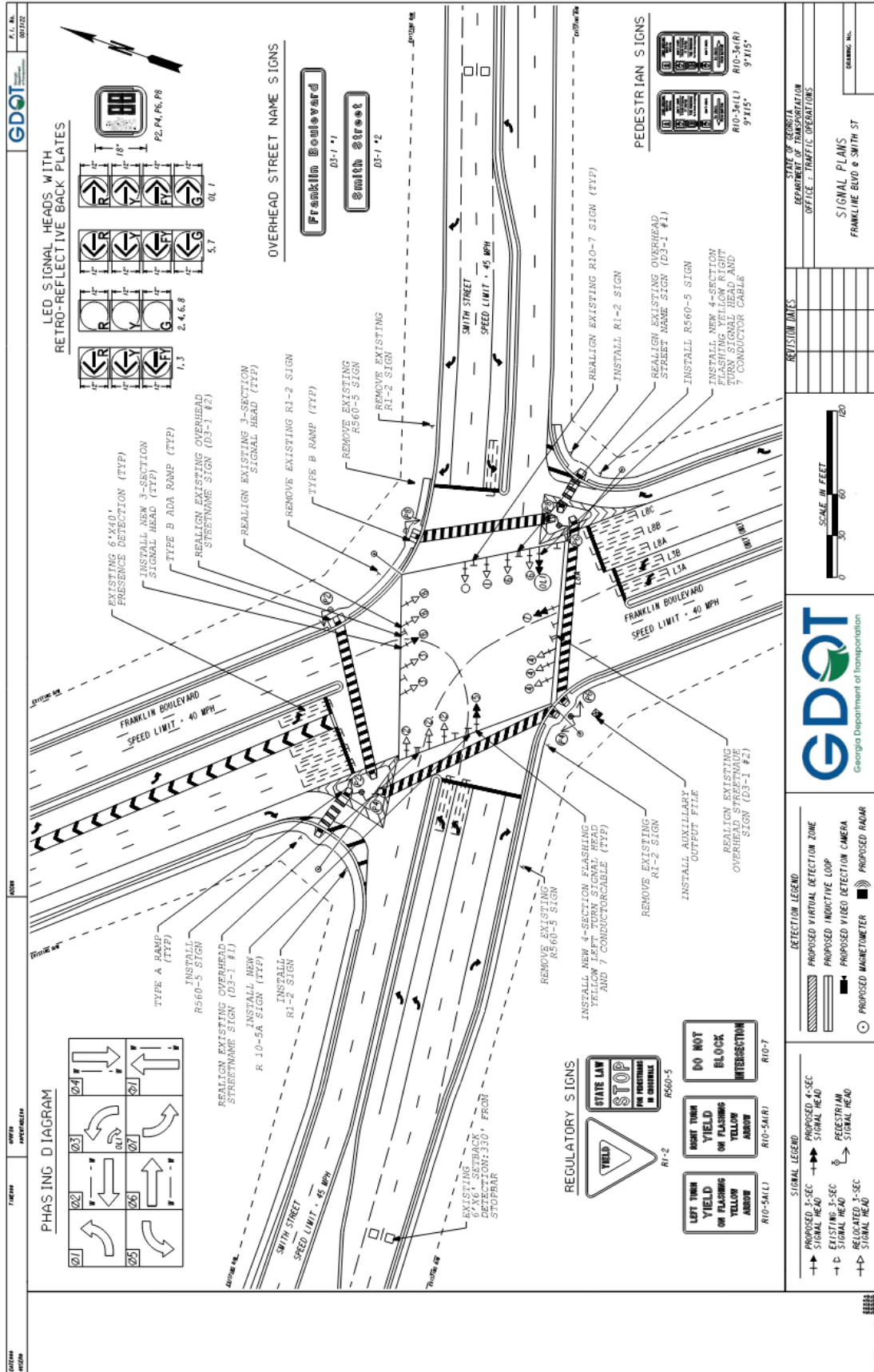

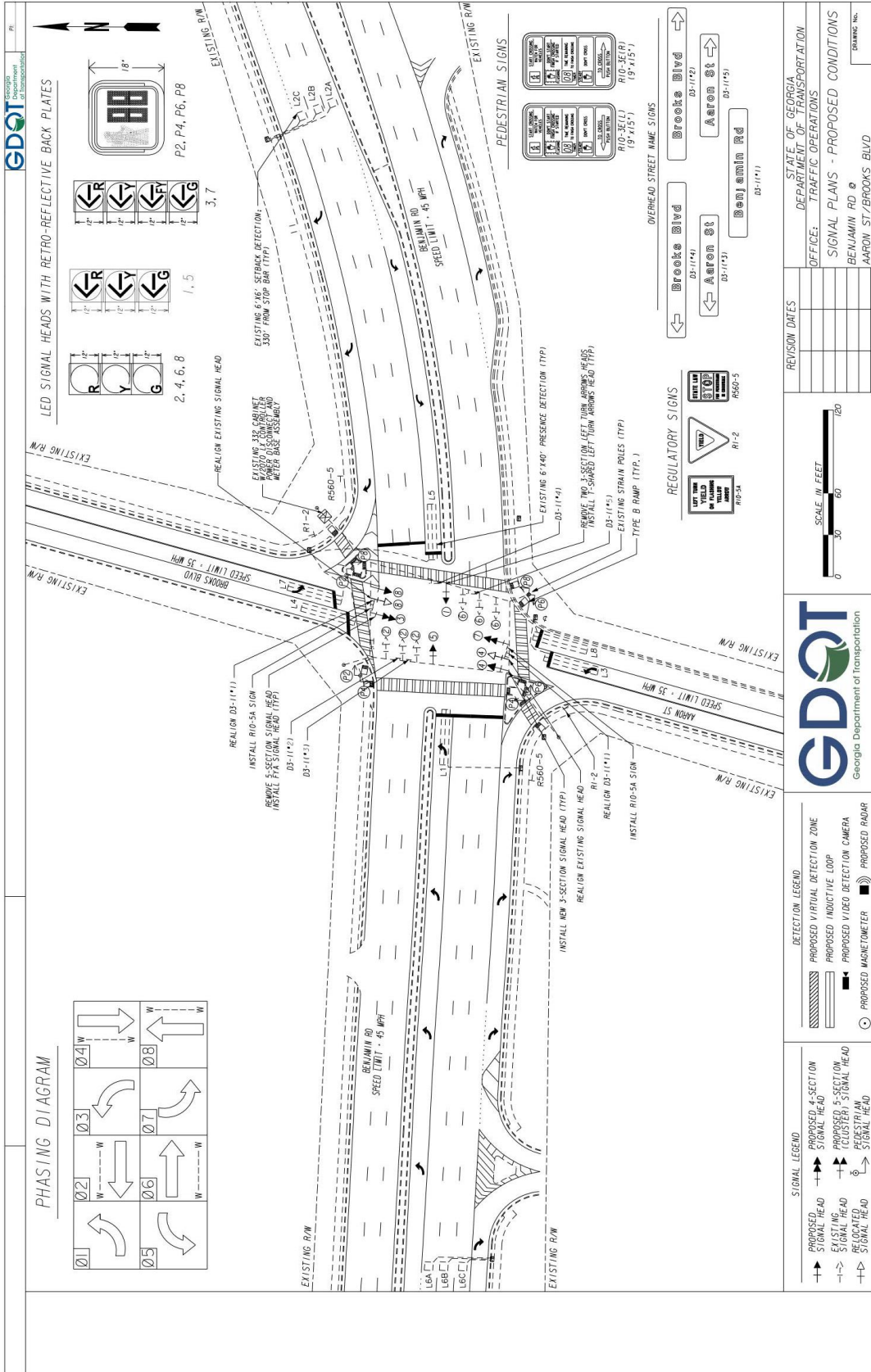

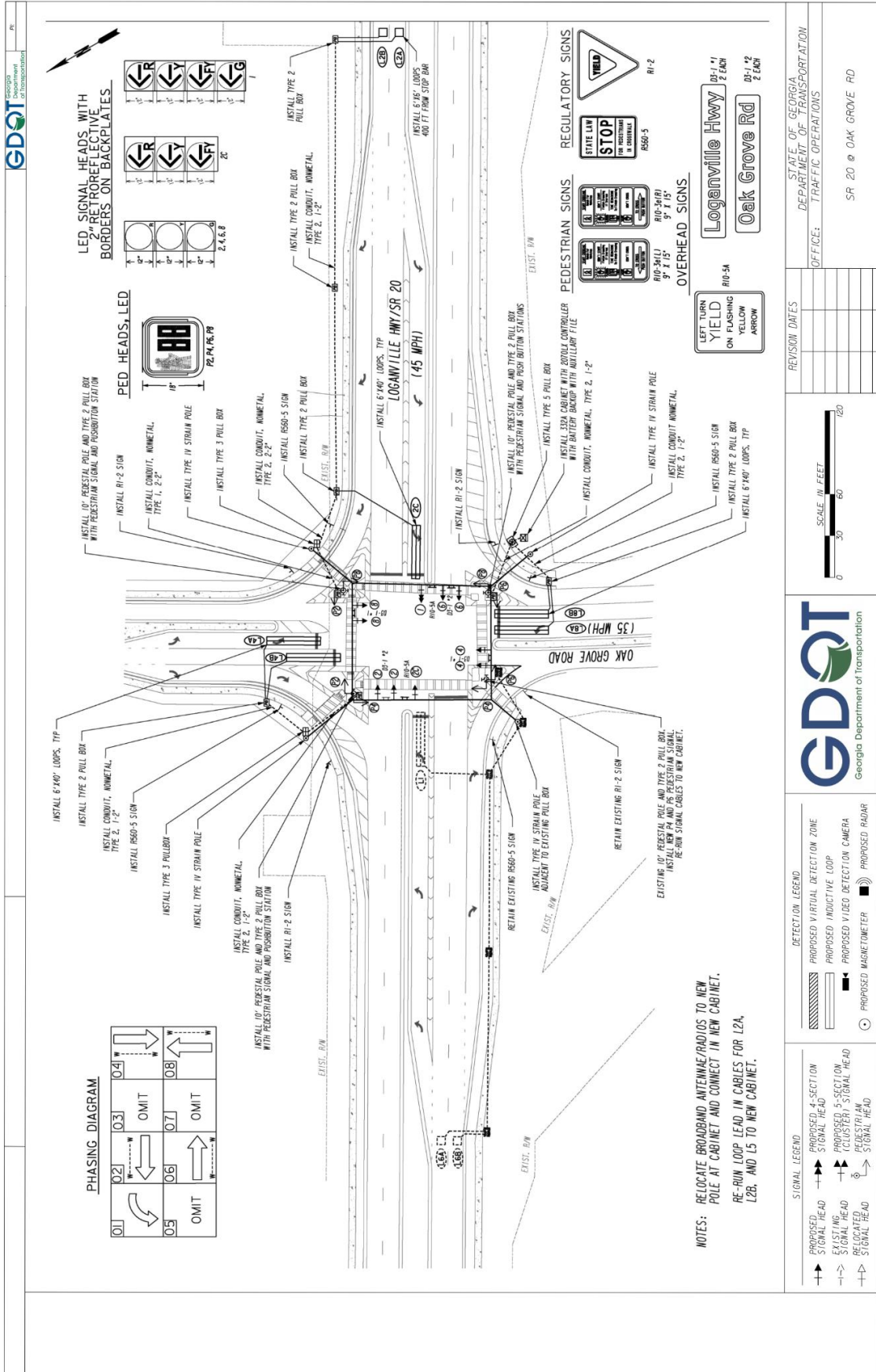

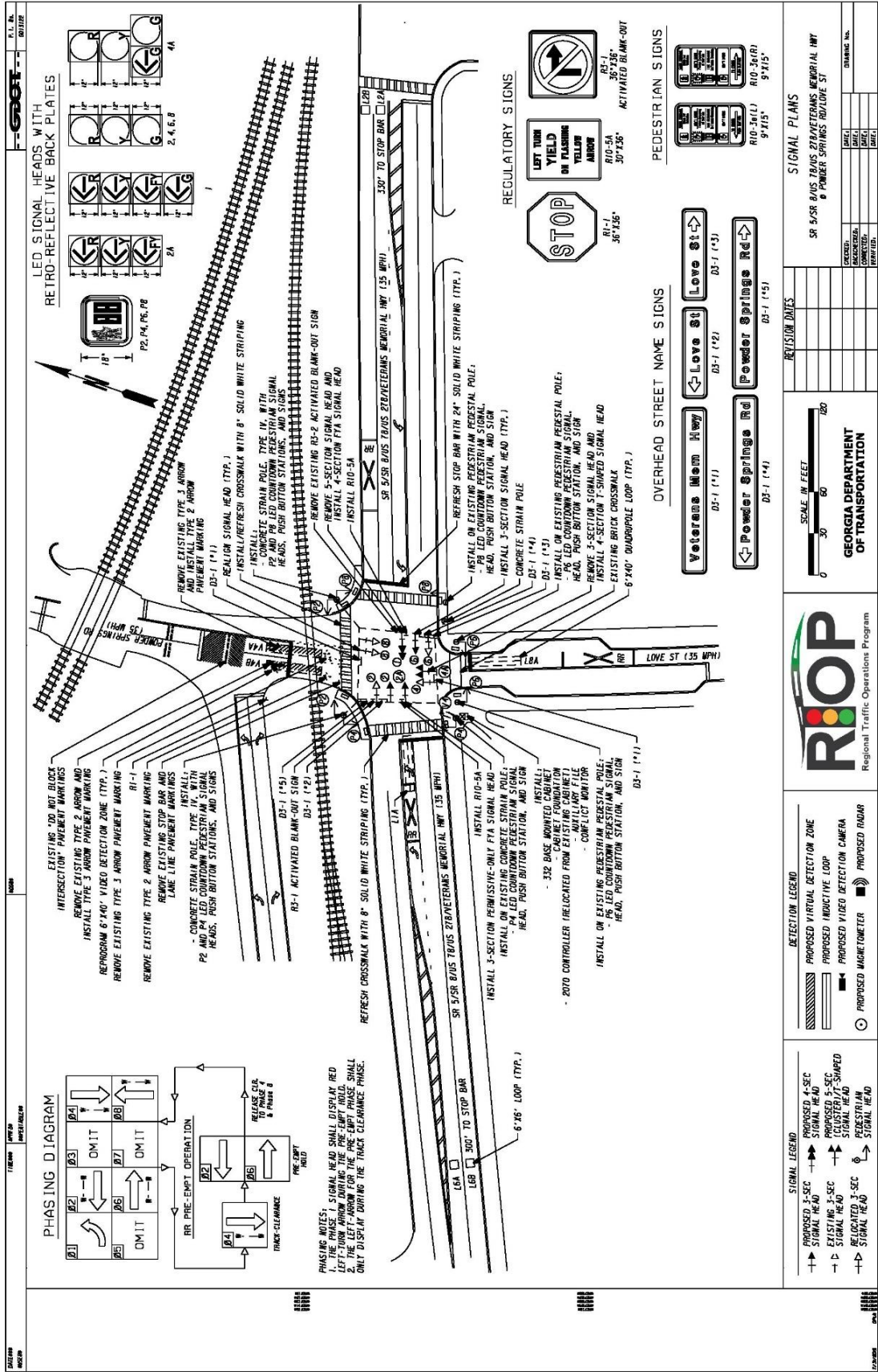

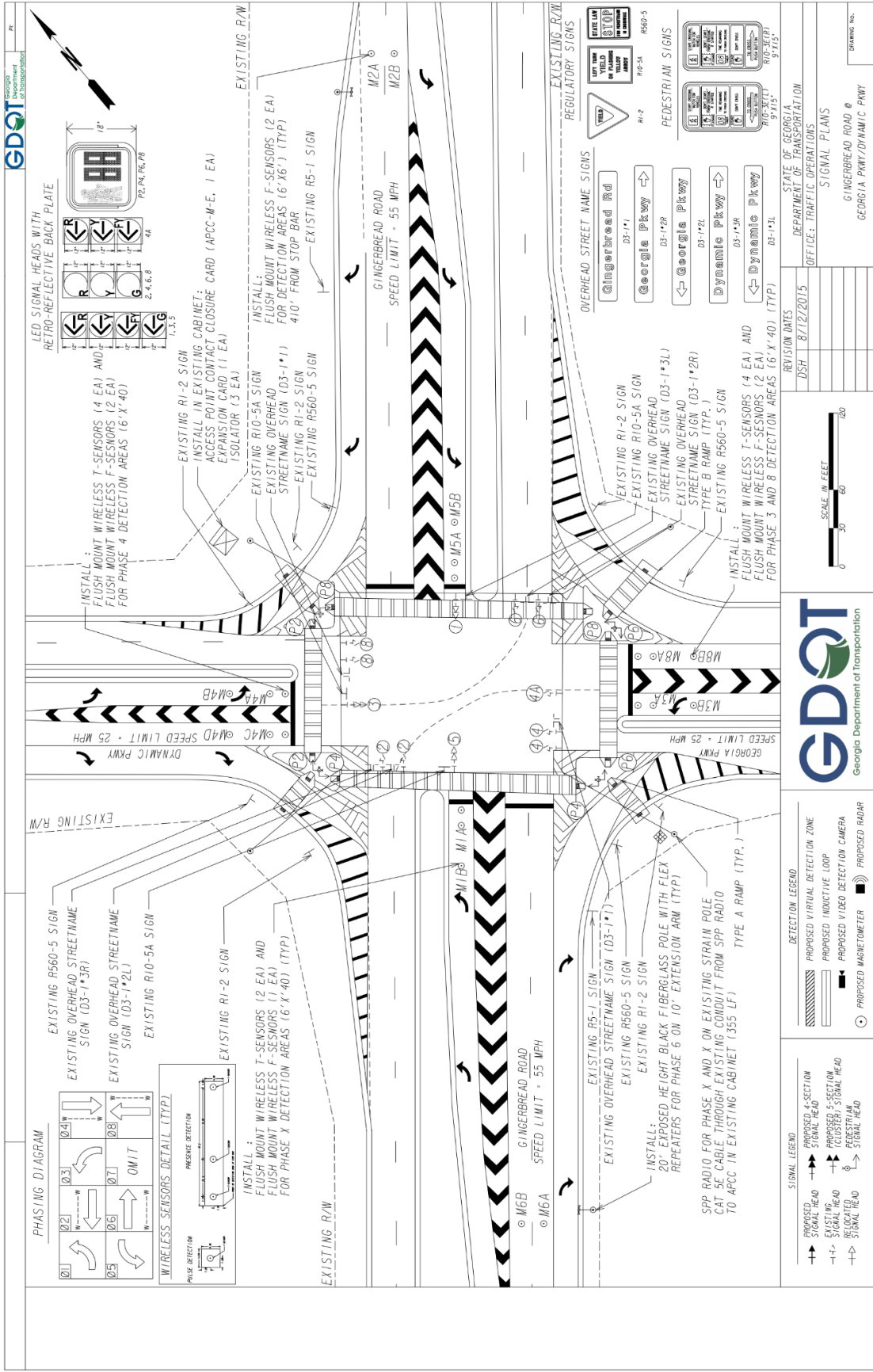

Appendix B. Vehicular Signal Head Placement Examples

Appendix B-1. Permissive Left Turns

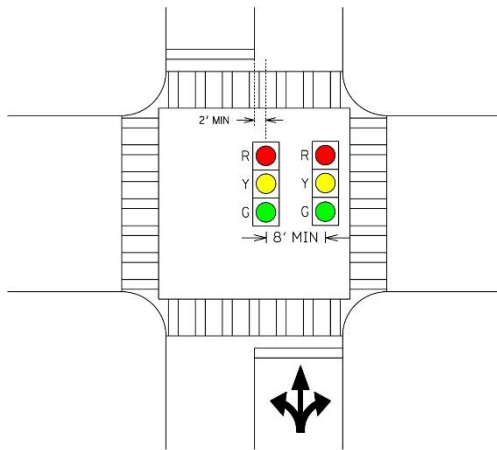

SINGLE LANE APPROACH
FIGURE I-1

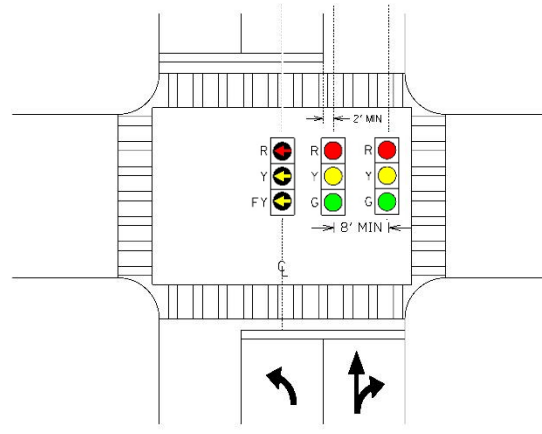

SINGLE LEFT TURN LANE
FIGURE I-2

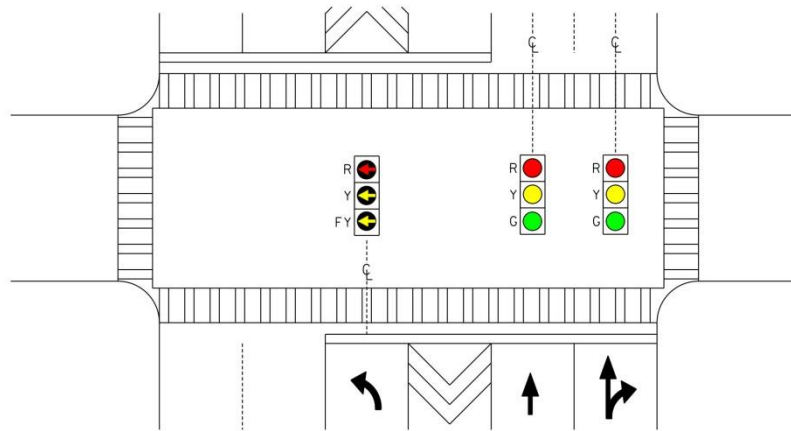

SINGLE LANE MEDIAN SEPARATED LEFT TURN LANE
FIGURE I-3

Appendix B-2. Protected/Permissive Left Turns

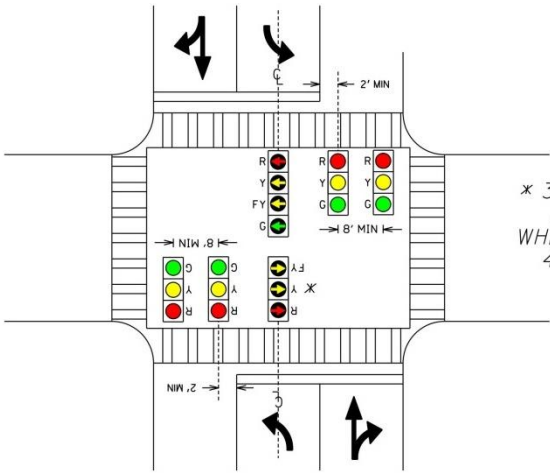

SINGLE LEFT TURN LANE
FIGURE 2-1

* 3-SECT FYA
REQUIRED
WHEN OPPOSITE
4-SECT FYA

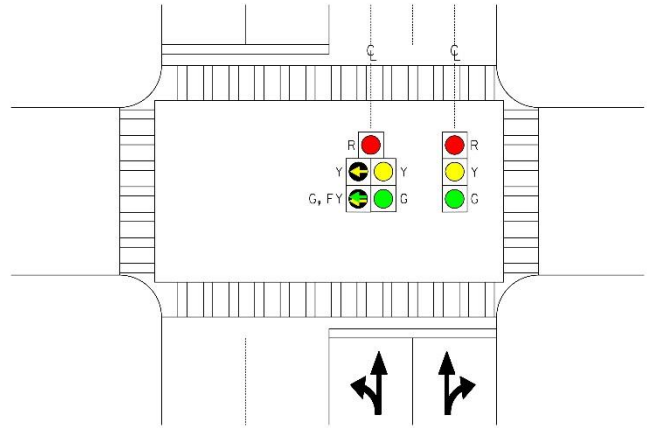

COMBINATION THRU-LEFT TURN LANE -
BIMODAL 5 SECTION SIGNAL HEAD
FIGURE 2-2

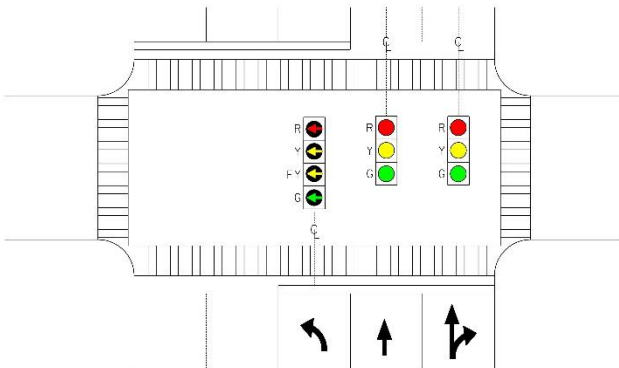

SINGLE LEFT TURN LANE
FIGURE 2-3

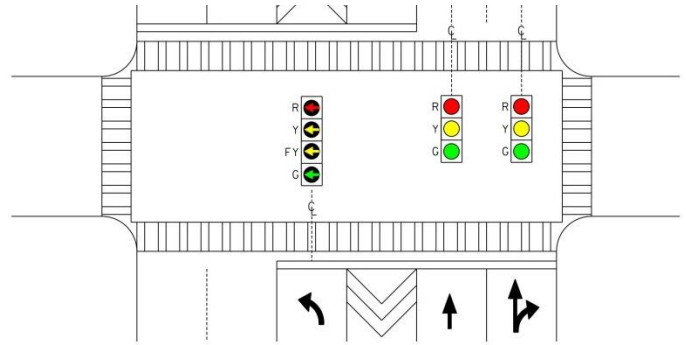

SINGLE MEDIAN SEPARATED LEFT TURN LANE
FIGURE 2-4

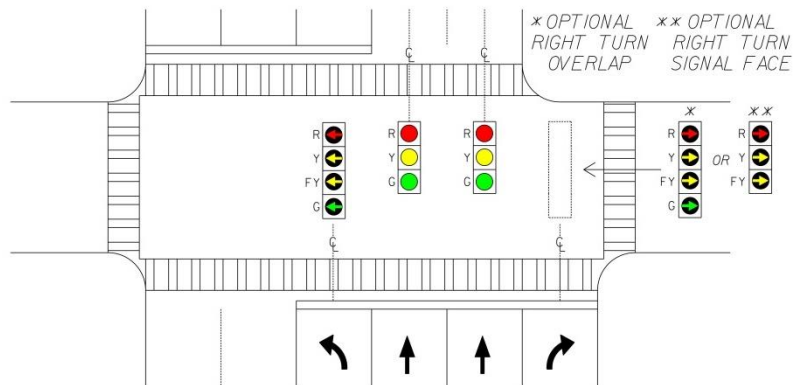

SINGLE LEFT TURN LANE W/ TWO THRU LANES AND RIGHT TURN LANE
FIGURE 2-5

Appendix B-3. Protected Only Left Turns

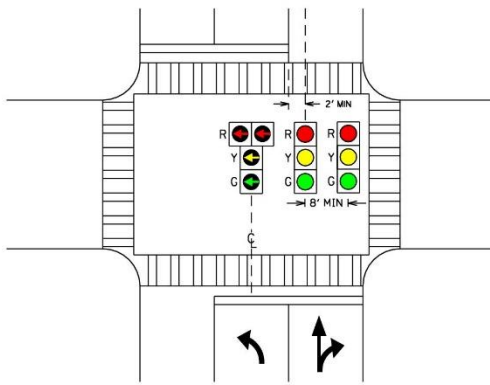

SINGLE LEFT TURN LANE
FIGURE 3-1

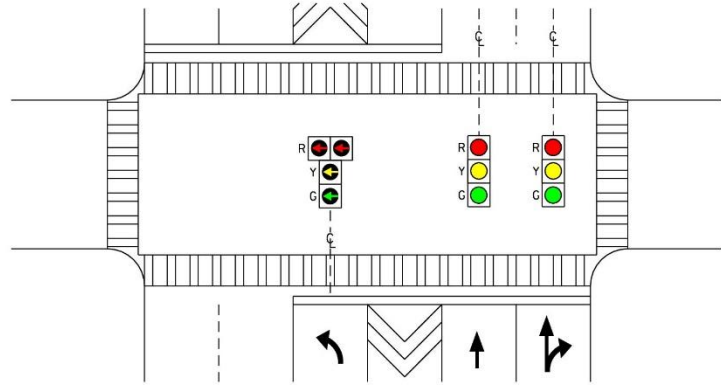

SINGLE MEDIAN SEPARATED LEFT TURN LANE
FIGURE 3-2

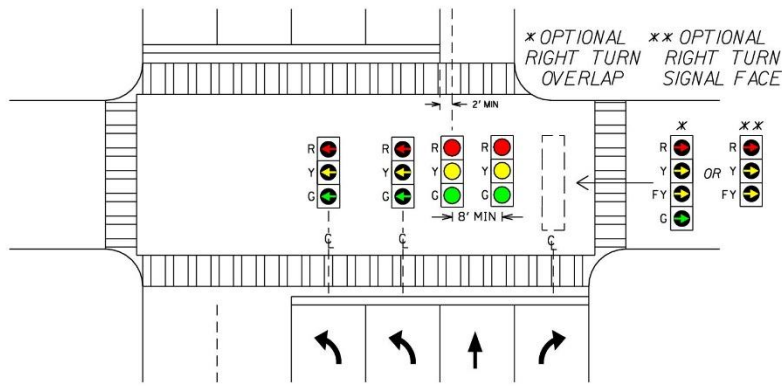

DUAL LEFT TURN LANES WITH THRU AND RIGHT LANES
FIGURE 3-3

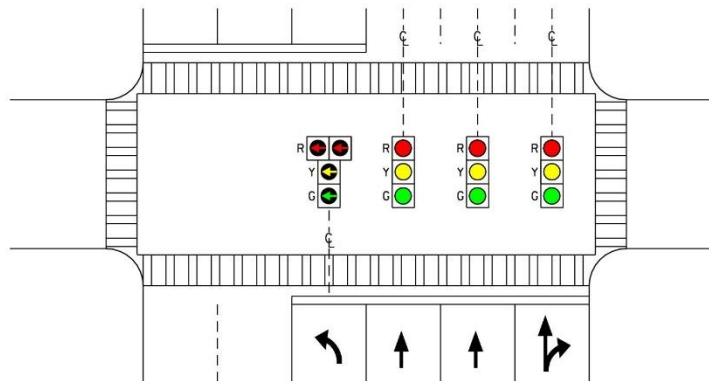

SINGLE LEFT TURN LANE W/ TWO THRU LANES AND THRU/RIGHT LANE
FIGURE 3-4

Appendix B-4. Split Phasing

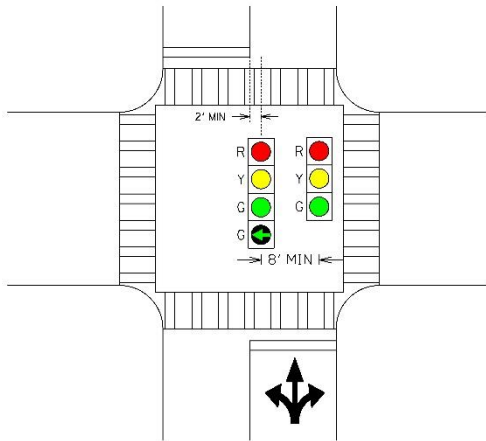

SPLIT PHASE SINGLE LANE APPROACH
FIGURE 4-1

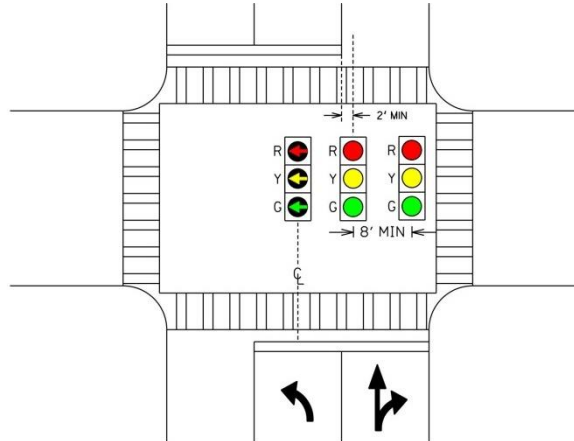

SPLIT PHASE SINGLE LEFT TURN LANE
FIGURE 4-2

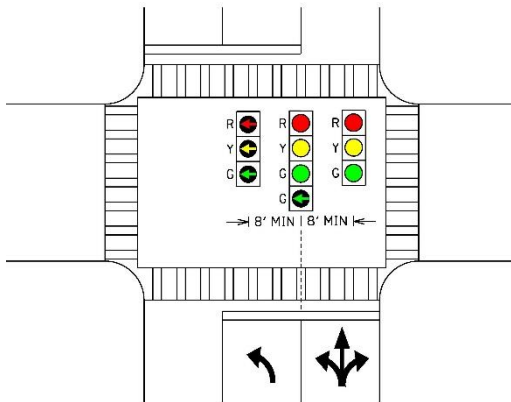

SPLIT PHASE LEFT TURN LANE
W/ COMBINATION LEFT TURN/THRU/RIGHT LANE
FIGURE 4-3

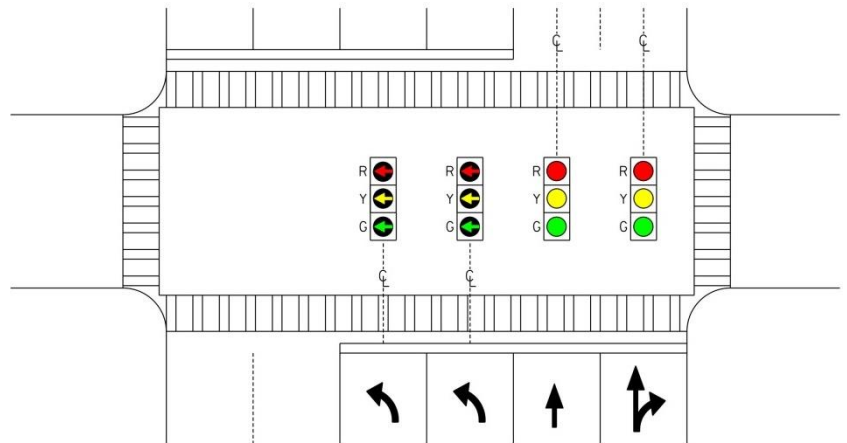

DUAL LEFT TURN LANES WITH THRU AND RIGHT LANES
FIGURE 4-4

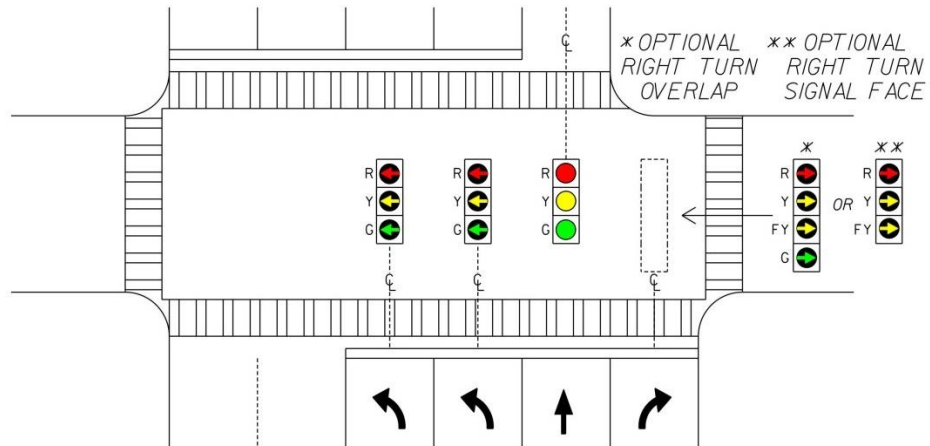

DUAL LEFT TURN LANES WITH THRU AND RIGHT LANES
FIGURE 4-5

Appendix B-5. T-Intersection

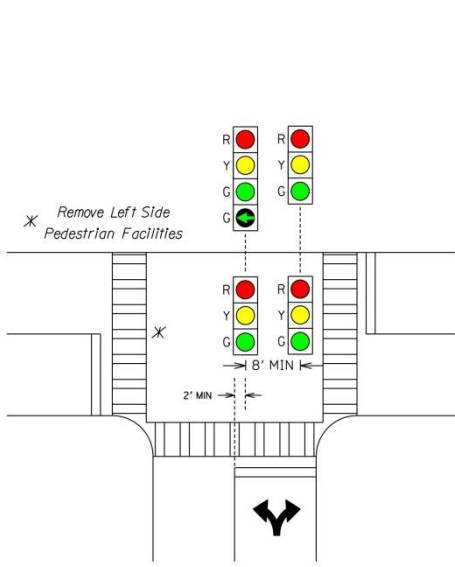

SINGLE LANE APPROACH
FIGURE 5-1

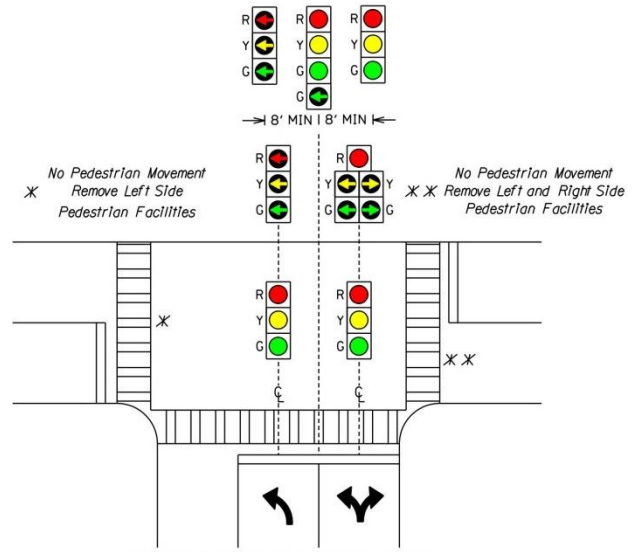

SEPARATE LEFT TURN LANE
COMBINATION LEFT TURN/RIGHT TURN LANE
FIGURE 5-2

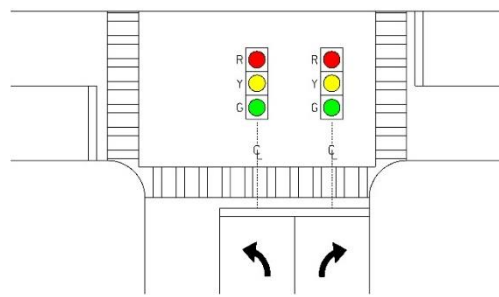

SEPARATE LEFT AND RIGHT TURN LANES
FIGURE 5-3

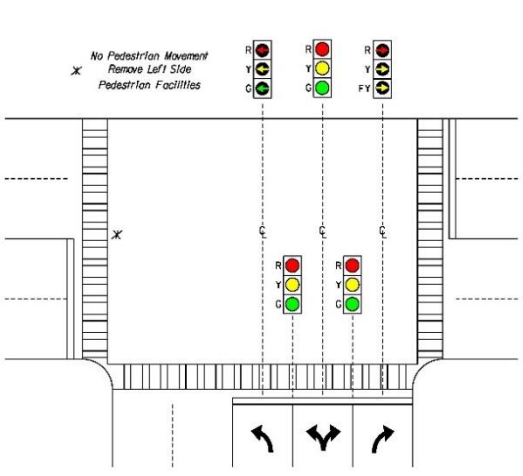

SEPARATE LEFT TURN LANE AND
RIGHT TURN LANE WITH SHARED CENTER LANE
FIGURE 5-4

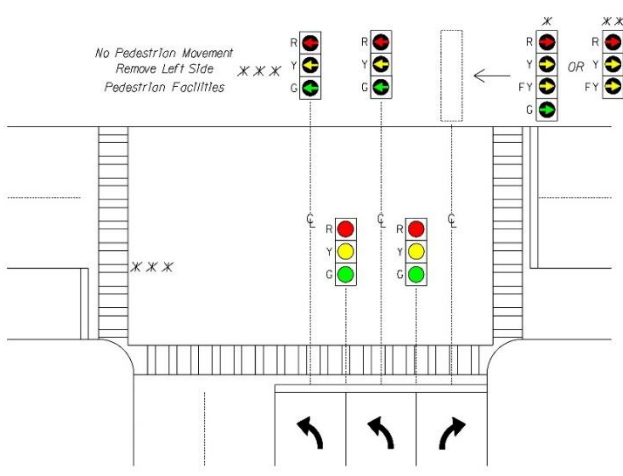

DUAL LEFT TURN LANES WITH SEPARATE RIGHT TURN LANE
FIGURE 5-5

* OPTIONAL
RIGHT TURN
OVERLAP
** OPTIONAL
RIGHT TURN
SIGNAL FACE

Intentionally Left Blank